



GO Design Requirements Manual

GO-DRM-STD-2017-Rev3

February 2020

GO Design Requirements Manual

GO-DRM-STD-2017-Rev3

Publication Date: February 7, 2020

COPYRIGHT © 2016

Metrolinx,

an Agency of the Government of Ontario

The contents of this publication may be used solely as required for services performed on behalf of Metrolinx or for and during preparing a response to a Metrolinx procurement request. Otherwise, this publication or any part thereof shall not be reproduced, re-distributed, stored in an electronic database or transmitted in any form by any means, electronic, photocopying or otherwise, without written permission of the copyright holder. In no event shall this publication or any part thereof be sold or used for commercial purposes.

The information contained herein or otherwise provided or made available ancillary hereto is provided “as is” without warranty or guarantee of any kind as to accuracy, completeness, fitness for use, purpose, non-infringement of third party rights or any other warranty, express or implied. Metrolinx is not responsible and has no liability for any damages, losses, expenses or claims arising or purporting to arise from use of or reliance on the information contained herein.

1 Preface

This is the 33rd edition of the *GO Design Requirements Manual* (also referred to as the *DRM*) and supersedes all previous editions. It incorporates the valuable feedback received from the Design Division since the March 2019 update.

This edition has been updated to reflect the removal of duplicated requirements that are currently being addressed in Design Standards: Easier Access Design Features, Integrated Design, Wayfinding & Signage, Accessible Parking Space Requirements, Bicycle Infrastructure, Station Building Interior Design, Station Building Interior Light Fixture Schedule, Fixtures and Furnishings – General Placement Requirements, Finishes and Materials, Station Building Interior Program Finishes Schedule.

The DRM is a reference tool for engineering and design consultants and internal Metrolinx staff. The DRM consists of requirements and technical details for the infrastructure requirements to design and build GO stations, terminals and facilities. The requirements may exceed industry regulations and codes. The DRM is part of a suite of publications that inform the design and construction of Metrolinx capital assets. It is applicable to new construction and retrofit capital infrastructure programs.

The DRM is available for external users to download via the Metrolinx public download site at http://www.gosite.ca/engineering_public/

February 2020

2 Contents

2.1 Table of Contents

1	Preface	3
2	Contents.....	4
2.1	Table of Contents	4
2.2	Table of Figures	7
2.3	Table of Tables	8
2.4	Table of Acronyms	9
3	Introduction	15
3.1	Overview	15
3.2	Ownership and Location.....	15
3.3	How to use the DRM	16
3.4	Codes and Regulations	16
3.5	Drawing Standards.....	17
3.6	Document Amendment Record	17
4	Guiding Principles	17
4.1	Universal Access.....	17
4.1.1	Overview.....	17
4.2	Customer Service.....	17
4.3	Sustainable Design	18
4.3.1	Smart Land Use and Livable Neighbourhoods	18
4.3.2	Materials & Construction / Operations Optimization	18
4.3.3	Energy and Resource Efficiency	18
4.3.4	Quality of Ambient Environment and Health	18
4.3.5	Emissions and Pollution Control.....	18
4.3.6	Corporate Policies	18
5	Site Program.....	19
5.1	Site Planning and Organization	19
5.1.1	Site Components and Typical Schematic Layout.....	19
5.1.2	Redundant Access	19
5.1.3	Mini-Platform	19
5.1.4	Designated Waiting Area (DWA).....	19
5.2	Rail Platform and Platform Access	20
5.2.1	Rail Platform	22
5.2.2	Rail Platform Canopies.....	24
5.2.3	Rail Platform Access–Tunnels/Ramps/Stairs.....	25
5.2.4	Elevators.....	27
5.2.5	Bridges and Overpasses	28
5.3	Bus Loops	29
5.3.1	Bus Loop Configuration Traffic Flow	29
5.3.2	Bus Radii	32
5.4	Passenger Pick-Up and Drop-Off (PUDO).....	33
5.5	Pedestrian Connections	34
5.5.1	Walkways	34
5.5.2	Delineated Crosswalks	34
5.6	Vehicular Access & Accommodations	34

5.6.1	Parking Stall Design Requirements.....	35
5.6.2	Multi-Level Parking Garages	35
5.7	“Green Zone”	38
5.7.1	Motorcycle/Scooter Parking	38
5.7.2	Carpool to GO Parking	39
5.7.3	EV Charging Station.....	39
5.8	Pavement and Line Markings	39
5.8.1	Asphalt Mixture.....	40
5.8.2	Concrete Paving	40
5.8.3	Slopes.....	40
5.9	Park and Ride Lots.....	46
5.10	At Grade Pedestrian Crossings	46
5.11	Landscaping & Civil Works.....	48
5.11.1	Plant Material.....	49
5.11.2	Islands/Curbs.....	50
5.11.3	Fencing	50
5.11.4	Site Furnishings.....	51
5.11.5	Civil Works.....	52
5.12	Geodetic Reference	54
5.12.1	Station Geographical Coordinates	54
5.12.2	Projection System.....	54
5.12.3	Three-Dimensional Geodetic Control Points.....	55
6	Building Program	56
6.1	Key Sustainability Accommodations	56
6.2	Bus Terminals	57
6.2.1	Dispatcher Room.....	57
6.3	Operational Facilities	57
6.3.1	Rail Operational Facilities.....	57
6.3.2	Bus Operational Facility	57
6.3.3	Bus Operational Facility Typology.....	58
6.3.4	Type “A” Bus Operational Facility.....	59
7	Technical Requirements.....	84
7.1	General Technical Requirements	84
7.2	Electrical	84
7.2.1	Supply of Primary and Secondary Power Sources	84
7.2.2	Generators.....	90
7.2.3	Uninterruptible Power Supply (UPS).....	92
7.2.4	Inverters.....	93
7.2.5	Transfer Switch (Automatic and Manual Bypass Switch).....	93
7.2.6	Distribution of Primary and Secondary Sources	94
7.2.7	Stations & Facilities	94
7.2.8	Service Duct Banks	96
7.2.9	Wiring Methods.....	97
7.2.10	Relay Protection and Metering	99
7.2.11	Receptacles.....	99
7.2.12	Switchboards	100
7.2.13	Panelboards	100
7.2.14	Switches and Disconnects	101
7.2.15	Switchgear.....	101
7.2.16	Building Automation System (BAS).....	101

7.2.17	Monitoring and Controls	101
7.2.18	Transformers	101
7.2.19	Motors and Controls	102
7.2.20	Monitoring and Controls	102
7.2.21	Wayside Power.....	104
7.2.22	Service Rooms Requirements (General)	104
7.2.23	Electrical Rooms.....	108
7.2.24	Communications and Hub Rooms.....	109
7.2.25	Illumination	113
7.2.26	Lighting Design Requirements	117
7.2.27	Lighting Control Design Criteria	121
7.2.28	Illumination Levels.....	123
7.2.29	Light Sources and Controls	127
7.2.30	LED Lighting Requirements	129
7.2.31	Lightning Protection, Grounding and Bonding	130
7.2.32	Lightning Protection.....	132
7.2.33	Identification	133
7.3	Communications	133
7.3.1	Closed Circuit Television (CCTV).....	133
7.3.2	Public Address System (PA)	150
7.3.3	Telephone Network	157
7.3.4	Talk-Thru System	157
7.3.5	Security Systems.....	157
7.4	Mechanical.....	162
7.4.1	Overview.....	162
7.4.2	Heating, Ventilation, and Air Conditioning (HVAC) Systems	162
7.4.3	Stations.....	163
7.4.4	Facilities.....	164
7.4.5	Air Curtain.....	164
7.4.6	Split Heat Pump Unit	164
7.4.7	HVAC Air Distribution	164
7.4.8	Air Terminal Unit.....	164
7.4.9	Custom Made Air Handling Unit	164
7.4.10	Piping and Pumps	164
7.4.11	Fan	165
7.4.12	Energy Recovery Ventilator.....	165
7.4.13	Air Filter and Accessory	165
7.4.14	System Control	165
7.4.15	Heater	165
7.4.16	Diffuser	166
7.4.17	Duct	166
7.4.18	Fire Damper.....	166
7.4.19	Connector	166
7.4.20	Insulation	166
7.4.21	Rooftop Air Handling Unit.....	166
7.4.22	Fuel Oil System	167
7.4.23	Natural Gas Piping System	167
7.4.24	Refrigerant Piping System.....	167
7.4.25	Building Automation System (BAS).....	167
7.4.26	Radiant Floor Heating and Snow Melting Systems.....	168
7.4.27	Plumbing and Drainage Systems	168

7.4.28	Fire Protection Systems	172
7.4.29	Identification, Appearance, and Noise/ Vibration	173
7.5	Fixtures and Furnishings	174
7.5.1	Shelters	174
7.5.2	Digital Signs at Line Stations, Terminals and Carpool Lots	174
7.5.3	Fare Systems	178
7.5.4	PRESTO Overview.....	178
7.5.5	Two Way Intercom.....	180
8	Heavy Rail	182
9	Information technology; Telecommunication & Systems	182
10	Appendix A – LEED Mandatory Credits	182
10.1	How to Use the GO LEED Mandatory Credit Checklist.....	182
10.2	LEED v.4 Mandatory Credits	183
10.3	LEED 2009 Mandatory Credits.....	190

2.2 Table of Figures

Figure 1: Document Overview	15
Figure 2: Typical Configuration of Mini Platforms	21
Figure 3: Typical Orientation of Locomotive End to Locate Mini Platforms	21
Figure 4: Typical Rail Platform Configuration	23
Figure 5: Typical Rail Platform Elevation	23
Figure 6: Typical Rail Platform Elevation - Section A	24
Figure 7: Typical Rail Platform Elevation - Section B	24
Figure 8: A. Linear Bus Loop Configuration Linear Traffic Flow	30
Figure 9: B. Island Bus Loop Configuration Clockwise Traffic Flow	31
Figure 10: C. Teardrop Bus Loop Configuration Counter Clockwise Traffic Flow	31
Figure 11: D. Bi-Directional Bus Loop Configuration and Traffic Flow	32
Figure 12: Bus Radii Turning Template	32
Figure 13: Typical PUDO Configuration.....	34
Figure 14: Motorcycle End of Parking Row Configuration	39
Figure 15: Motorcycle Corner/Dead Space Configuration	39
Figure 16: Vehicular Parking Diagram	42
Figure 17: Vehicular Parking Diagram	43
Figure 18: Line Marking – Row Parking Stalls	43
Figure 19: Hatched Parking Area Configuration	44
Figure 20: Line Marking for Islands.....	44
Figure 21: Crosswalks in Parking Lots and Major Crosswalks on Access Routes	45
Figure 22: Line Marking – Pavement Arrows.....	45
Figure 23: Geographical Coordinate Placement.....	54
Figure 24: Station Building Program – Wayfinding and Customer Journey Points	56
Figure 25: Emergency Power Distribution with Generator.....	92
Figure 26: Lighting Design Requirements - Bus Loops	117
Figure 27: Lighting Design Requirements - Parking Garage	118
Figure 28: Lighting Design Requirements - Surface Parking.....	119
Figure 29: Lighting Design Requirements - Rail Platform.....	120
Figure 30: Conceptual Interior Elevator Cab Application (Diagram only)	182

2.3 Table of Tables

Table 1: Rail Platform Design Criteria.....	22
Table 2: Rail Platform Stair Design Requirements	26
Table 3: Parking Stall Requirements	35
Table 4: Slopes	40
Table 5: Line Markings.....	41
Table 6: Line Marking (Parking Structures Only).....	41
Table 7: At Grade Pedestrian Crossings	46
Table 8: Bus Operational Facility Typology	58
Table 9: Exterior Circulation.....	59
Table 10: Landscaping.....	60
Table 11: Signage	60
Table 12: Clearance and Circulation.....	61
Table 13: Structural Elements.....	61
Table 14: Architectural Elements	61
Table 15: Architectural Finishes.....	64
Table 16: Fixtures	65
Table 17: Specialties.....	66
Table 18: Life Safety	67
Table 19: Safety and Security.....	67
Table 20: Communications	70
Table 21: Mechanical.....	71
Table 22: Electrical.....	72
Table 23: Future Expansion	73
Table 24: CCTV	73
Table 25: Automated or Monitored Gates.....	73
Table 26: Main Gate.....	74
Table 27: Main Gate.....	74
Table 28: Safety and Training Programs	75
Table 29: Administration and Services - Operations	76
Table 30: Maintenance Facilities - Service Lanes	77
Table 31: Maintenance Facilities - Plant Maintenance	78
Table 32: Maintenance Facilities - Training Area	79
Table 33: Maintenance Facilities - Shop Employee Service Rooms	80
Table 34: Storage Facilities - Bus Storage Garage	81
Table 35: Storage Facilities - Stores.....	81
Table 36: Other – Interior Spaces.....	82
Table 37: Other – Exterior Spaces.....	83
Table 38: Utilization Voltages #1	85
Table 39: Utilization Voltages #2	85
Table 40: Backup Power Systems – Design Requirements	88
Table 41: Generators Noise Levels	90
Table 42: Exterior Enclosure.....	91
Table 43: Electrical Requirements at Stations and Facilities.....	94
Table 44: Minimum Room Dimensions	111
Table 45: Illumination Levels	124
Table 46: Interior Lighting Illumination Levels.....	124
Table 47: Exterior Lighting Illumination Levels	125
Table 48: Lighting Levels for Inside a Covered Parking Facility.....	126
Table 49: Interior Lighting Sources and Controls.....	127

Table 50: Exterior Lighting Sources and Controls	128
Table 51: CCTV Coverage Type (Image Quality)	137
Table 52: CCTV Camera Placement - Parking	137
Table 53: CCTV Camera Placement – Stations Exterior and Interior.....	140
Table 54: CCTV Camera Placement – Rail Platforms, Tunnels, Bridges, Bus Platforms	142
Table 55: CCTV Camera Placement - Service Rooms, Service Buildings, Bunkers, Devices.....	145
Table 56: CCTV Camera Placement - Facilities – Storage/Garage (Bus), Storage/Layover (Rail)	146
Table 57: Heating, Ventilation, and Air Conditioning (HVAC).....	162
Table 58: Building Automation System (BAS)	167
Table 59: Fire Protection System.....	172
Table 61: Appendix A – LEED v.4 Mandatory Credits for GO Stations	183
Table 62: Appendix A – LEED v.4 Mandatory Credits for GO Maintenance Facilities	186
Table 63: Appendix A – LEED 2009 Mandatory Credits for GO Stations.....	190
Table 64: Appendix A - LEED 2009 Mandatory Credits for GO Maintenance Facilities.....	193

2.4 Table of Acronyms

Acronym	Definition
AC	Alternating Current
AED	Automated External Defibrillators
AFF	Above Finished Floor
ANSI	American National Standards Institute
AODA	Accessibility for Ontarians with Disabilities Act
APTA	American Public Transportation Association
AREMA	American Railway Engineering and Maintenance of Way Association
ASHRAE	American Society of Heating, Refrigerating, and Air-Conditioning Engineers
ATR	Above top of rail
ATS	Automatic Transfer Switch
AVL	Automatic Vehicle Location
AVM	Add Value Machine
AWG	American wire gauge
BAS	Building Automation System

CC	Concentrator Complex
CCTV	Closed-circuit television
CEC	Canadian Electrical Code
CGSB	Canadian General Standards Board
CGVD	Canadian Geodetic Vertical Datum
CISPR	The Comité International Spécial des Perturbations Radioélectriques
CL	Centre Line
CN	Canadian National
CNIB	Canadian National Institute for the Blind
CP	Canadian Pacific
CPTED	Crime Prevention Through Environmental Design
CPU	Central processor unit
CQD	Credit Query Device
CRI	Colour Rendering Index
CSA	Canadian Standard Association
CSRS	Canadian Spatial Reference System
CT	Current Transformers
cUL	Canadian Underwriters Laboratories
DC	Direct Current
DGZ	Dedicated Ground Zone
DHW	Domestic Hot Water
DRM	Design Requirements Manual
DTMF	Dual tone multi-frequency
DWA	Designated Waiting Area

EEMAC	Electrical Equipment Manufacturers Association of Canada
EIA	Electronic Industries Alliance
EMT	Electrical Metallic Tubing
EPA	Environmental Protection Agency
ERV	Energy recovery ventilators
ESA	Electrical Safety Authority
EV	Electrical Vehicle
FCC	Federal Communications Commission
FLC	Fuzzy Logic Control
FTA	Federal Transit Administration
GFI	Ground Fault Circuit Interrupters
GTHA	Greater Toronto Hamilton Area
HCR	Handheld Card Reader
HM	Hollow Metal
HOV	High occupancy vehicle
HP	Horse Power
HVAC	Heating, ventilation and air conditioning
IAQ	Indoor Air Quality
IEC	International Electrotechnical Commission
IEEE	The Institute of Electrical and Electronics Engineers
IES	Illuminating Engineering Society
IESNA	Illuminating Engineering Society of North America
IGBT	Insulated Gate Bipolar Transistors
IR	Infrared Radiation

IT	Information Technology
LED	Light-emitting diode
LEED	Leadership in Energy and Environmental Design
LRT	Light Rail Transit
LV	Low voltage
MCC	Motor Control Centres
MIL STD	Military Standard
MOE	Ministry of the Environment
MRL	Machine-Room-Less
MTM	Modified Transverse Mercator
MTO	Ministry of Transportation
NAD	North American Datum
NEMA	National Electrical Manufacturer Association
NFPA	National Fire Protection Association
NPT	National Pipe Thread
NRC	National Research Council
OBC	Ontario Building Code
OESC	Ontario Electrical Safety Code
OHSA	Occupational Health and Safety Act
OPSD	Ontario Provincial Standard Drawing
PA	Public Address
PA	Public Address System
PCB Card	Printed circuit board card
PDF	Photometric Digital File

PIR	Passive Infrared Radiation
PLC	Programmable Logic Controller
PPUDO	Passenger Pick up and Drop off
PSR	Pre-Start Health and Safety Reviews
PT	Potential Transformers
PTZ	Pan Tilt Zoom
PUC	Public Utilities Commission
PVC	Permanent Virtual Circuit
PWM	Pulse width modulation
RGS	Rigid galvanized steel
ROW	Right of way
RSA	Railway Safety Act
RFI	Radio Frequency Interference
SCADA	Supervisory control and data acquisition
SCC	Station Control Computer
SCR	Silicon Control Rectifiers
SFTP	Station Fare Transaction Processor
SMACNA	Sheet Metal and Air Conditioning Contractors National Association
SOV	Single occupant vehicle
SPD	Surge Protective Devices
SPOS	Station Point of Sale
STC	Sound Transmission Class
TC	Tangent-Curve
TCP/IP	Transmission Control Protocol/Internet Protocol

T/O	Top of
TSSA	Technical Standards and Safety Authority
TTC	Toronto Transit Commission
TVM	Ticket Vending Machine
TVSS	Transient Voltage Surge Suppression
TWSI	Tactile Walking Surface Indicator
ULC	Underwriters Laboratories of Canada
UPE	Union Pearson Express
UPS	Uninterruptible Power Systems
U/S	Underside
USB	Universal Serial Bus
VCP	Visual Comfort Probability
VOC	Volatile Organic Compound
VT	Voltage Transformer
WAP	Wireless Access Points
WC	Water Closet
WMA	Wheeled Mobility Aids

3 Introduction

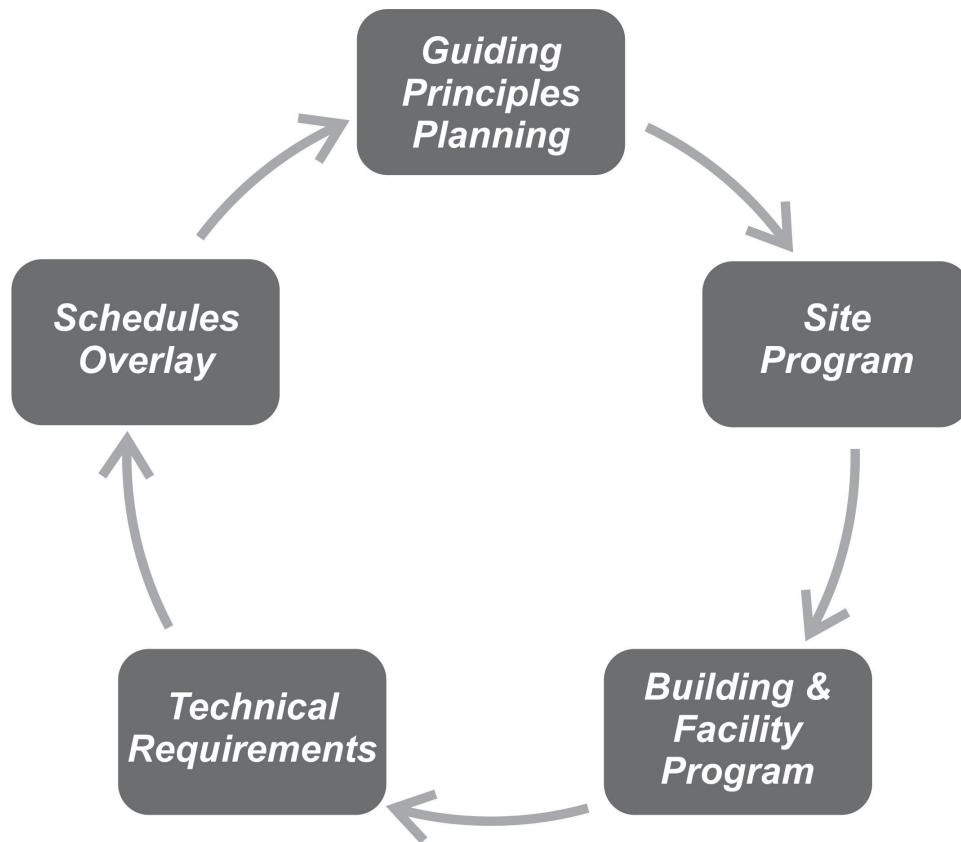

Figure 1: Document Overview

3.1 Overview

GO Transit is an inter-regional public transit system in Southern Ontario who primarily serves the GTHA, with operations extending to several communities in the Greater Golden Horseshoe. GO Transit operates commuter rail and coach bus services that connect with other regional transit providers such as VIA Rail Canada, the Toronto Transit Commission (TTC), and local municipal bus services.

This GO Design Requirements Manual (DRM) is a document that, along with Metrolinx Design Standards, outlines the standard requirements and technical details to design and build GO stations, terminals, and facilities.

This Manual balances and harmonizes corporate objectives, stakeholder requirements, and industry best practice by defining a performance-based set of standard technical requirements used as detailed instructions for designers and users.

3.2 Ownership and Location

GO Transit owns this Manual, in both printed and/or digital form, and will keep a record of issuance, and forward amendments to all consultants, designers, and contractors registered with us as Manual Holders.

Manual Holders may reproduce the contents of this DRM for use as required during a project assignment from GO Transit, and is responsible to ensure that the most recent version, and all its requirements, is used at the time the assigned project.

3.3 How to use the DRM

The DRM is the starting point of infrastructure technical requirements for GO Stations, Terminals, and Facilities.

It has requirements that are performance based and may exceed industry regulations and codes.

The DRM does not absolve the designer of record from current regulations and codes or professional duty of care.

Information is in the order of design development, starting with identification of program elements, site planning, and then to technical details such as electrical, mechanical, communications, etc.

Technical requirements are performance-based and expected to be used as the starting point for design development. The DRM is part of a suite of products that shall be used to inform the design.

The suite of products also includes:

- Standard Drawings
- Standard Specifications
- GO Transit Track Standards
- Design Standards

3.4 Codes and Regulations

It is required that consultants design in accordance with current version of all applicable standards, regulations, and codes to the approval of all authorities having jurisdiction.

Where design alternatives will provide substantially equivalent or where conflicts exist between the requirements of this Manual and standards or legislation enacted by the federal or provincial governments, the most stringent requirements shall apply.

Consultants for specific projects shall define codes as applicable and list them in the contract tender documents.

Other codes and regulations, imperative to the business that must be adhered to include but not limited to:

- Ontario Building Code (OBC)
- Accessibility for Ontarians with Disabilities Act (AODA)
- Railway Safety Act (RSA)
- Transport Canada Grade Crossing Regulations
- Canadian Road/Railway Grade Crossing Detailed Safety Assessment Field Guide
- Transport Canada RTD-10 Technical Standards Manual; RTD-10 will govern requirements for active warning system
- AREMA (American Railway Engineering and Maintenance of Way Association) Communications and Signals Manual

- Existing Railway Corridors Standard and Specifications for Crossing Warning Systems
- Manual of Uniform Traffic Control Devices for Canada
- Ontario Provincial Standards

3.5 Drawing Standards

For Drawing Standards, refer to the CADD/ BIM Standards Manual located on MyLinx and the Metrolinx external website in the GO Standard Drawings and Specifications tab.

All project specifications to be developed in the current edition of National Master Specification (NMS)'s MasterFormat™.

3.6 Document Amendment Record

The Amendment Record identifies revisions, by subject category and date. Consultants, designers, and contractors shall use the Amendment Record to ensure they are working from the latest version. An e-mail notification is issued whenever a revision/addition has been made to the Design Requirements Manual. The revision/addition is noted on the Amendment Record and immediately posted on our intranet and external website by the Standards team. The Amendment Record can be found in the DRM as Appendix A.

4 Guiding Principles

4.1 Universal Access

4.1.1 Overview

The GO Design Requirements Manual Guiding Principles underpin the end-to-end design development process.

The Guiding Principles define what is truly important for the success in delivering an EASY customer experience and minimizing operational costs.

They serve as the foundation for the application of technical requirements in existing site conditions.

GO Transit strives to build, for all customers, an effective and fully accessible public commuter rail and bus service.

4.2 Customer Service

The GO customer journey is a series of sections that is identified with an integrated, seamless, harmonized, customer-focused approach with related key brand touch points of interaction in station design.

The mission of GO Transit is to deliver an easy and delightful passenger experience.

The five strategic priorities include:

- Design Excellence
- Delight and eliminate barriers

- Promote seamless travel
- Strong partnerships and offerings
- Communications

4.3 Sustainable Design

GO has adopted American Public Transportation Association's (APTA's) framework for approaching transit sustainability with supporting Guiding Principles relevant to GO's infrastructure.

4.3.1 Smart Land Use and Livable Neighbourhoods

- Encourage neighbourhood integration and connectivity and the provision of green amenities
- Reduce heat island effect
- Increase soft landscaping are key drivers

4.3.2 Materials & Construction / Operations Optimization

- Flexibility and longevity
- Green construction practices and materials
- Address easy long term maintenance and adaptability/conversion

4.3.3 Energy and Resource Efficiency

- Lower the energy consumption and carbon footprint
- Look for operational and maintenance cost savings (i.e. energy harvesting, conservation/recovery and efficiency)

4.3.4 Quality of Ambient Environment and Health

- Provide a comfortable, healthy and safe environment

4.3.5 Emissions and Pollution Control

- Contribute to reduced air emissions and wastewater discharges
- Strategies for waste reduction and water conservation

4.3.6 Corporate Policies

Implement corporate policies that support green operations throughout the life of the facility, such as Green Cleaning, Solid Waste Management, and Green Education, and select LEED credits for certification.

As the industry evolves and new certifications become relevant to GO, they too can be explored, upon approval from Metrolinx.

4.3.6.1 GO LEED Credits

All buildings, terminals, and facilities are to achieve LEED certification, refer to appendix A. Specifically, select credits have been identified to ensure that only LEED credits that bring value to GO Transit's goals of energy efficiency and reduced operating and maintenance costs are targeted.

5 Site Program

5.1 Site Planning and Organization

Station site planning consists of a system of components that support the GO transit service.

Key principles in planning and organizing GO sites include:

- Separate modes of travel
- Connectivity to community pathways, walkways and transit
- Plan for future/flexibility
- Intuitive wayfinding to major elements
- Maximization of barrier free routes
- Network and pedestrian pathways
- Use of sustainable materials and technologies
- Integration with local communities and municipalities

5.1.1 Site Components and Typical Schematic Layout

5.1.1.1 Accessible Route

The accessible route is defined as a continuous unobstructed external and internal path connecting all accessible elements and spaces to enable personal barrier free mobility.

At GO facilities, the accessible route is identified as the travel path to/from/between the barrier free parking or drop off area, to the rail mini platform / bus platform.

5.1.2 Redundant Access

Provide a secondary barrier-free means of access/egress from the rail platform to the station building or pick-up area.

All island platforms shall be equipped with two elevators connecting to an underground pedestrian tunnel or an overhead pedestrian bridge.

Side platforms shall have various direct access points where covered ramps are the preferred means of egress.

5.1.3 Mini-Platform

Barrier-free access to the trains is provided by an accessible elevated “mini-platform” which is aligned with the designated accessible rail car. Refer to Standard Drawings for mini-platform details.

5.1.4 Designated Waiting Area (DWA)

The Designated Waiting Area (DWA) at GO stations is to be located on the rail mini-platform.

It is intended to be a convenience feature, whereby a customer can expect to avail assistance and have a reasonable sense of safety.

The DWA has augmented functionality and visibility at the station mini-platform. Key features include:

- Enhanced lighting
- Dedicated CCTV coverage
- Signage
- Two-way communications device
- PA system
- Overhead cover (canopy)
- Bench seating on rail platform in the proximity of the DWA
- Enhanced accessibility features in the mini-platform design
- Wayfinding signs on the accessible route
- Station ID sign
- Minimum horizontal and vertical clearances as mandated by functionality; and advanced warning identifiers

5.2 Rail Platform and Platform Access

Refer to respective GO Transit Track Standards for track standards.

Rail platforms are a foundational item to GO rail stations. Their orientation, design, alignment, geometry, and site conditions are the framework around which all other site components are configured.

- The use of side platforms is preferred
- Island platforms to allow for multiple points of access and egress
- Locate the platforms to minimize travel distances to adjacent transit modes and barrier-free path of travel.
- Where there are reduced width locations, include warning pavement markings and signage

When locating and orienting the mini-platform the steps outlined below shall be followed:

Step 1–Orient mini-platform, with an understanding of train consist orientation and operation

Step 2–Locate mini-platform and rail platform dimension, dependent on island vs. side platform configuration in accordance with criteria and specifications and subsequent tables.

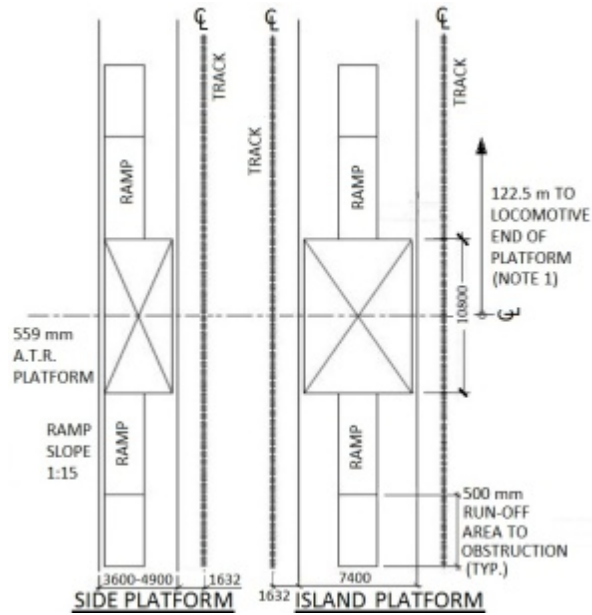

Figure 2: Typical Configuration of Mini Platforms

Note 1: The Locomotives are at the east end in Union Station. Refer to Locomotive Orientation Figure 3.

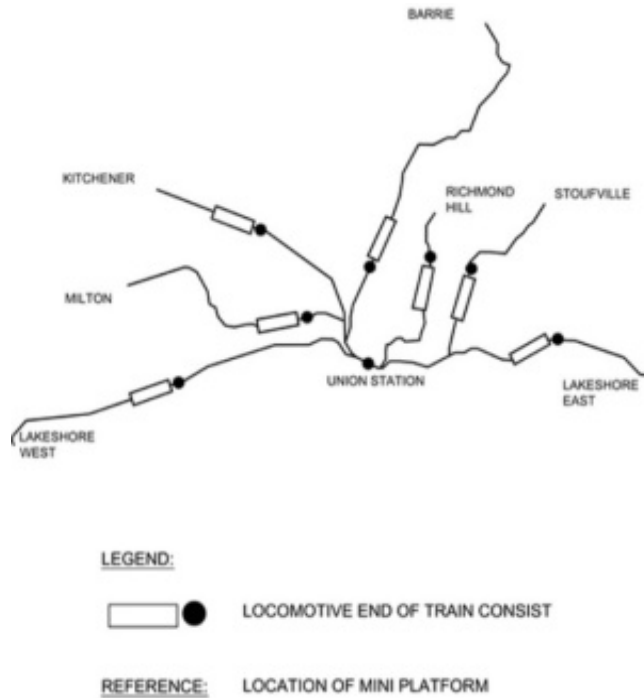

Figure 3: Typical Orientation of Locomotive End to Locate Mini Platforms

5.2.1 Rail Platform

These criteria are based on CN Rail data, applicable also to CP Rail, for preliminary design. Detail design shall be reviewed by the appropriate railway authority and GO Transit, at which time, some dimensions may be defined more precisely.

Table 1: Rail Platform Design Criteria

Rail Platform Design Criteria	Specifications
Track centres, centre line to centre line, new station facilities only*	3.96 m
Width of island platform	7.4 m (min.)
Width of side platform	3.6 m (min. clear width) 4.9 m (min. including shelter)
Length of platform	315 m
Center line of mini-platform to locomotive end of main platform (Refer to Figure D-4 for location of locomotive for each corridor)	122.5 m
Centre line to centre line of tracks serving island platform	10.67 m
Clearance from edge of platform to platform structures (shelters/stair enclosures, etc.)	2.44 m
Usable platform area	Exclude the width of the Tactile Walking Surface Indicator (TWSI) tiles when calculating usable platform space; and Consider specific points of congestion (e.g., no standing zones) when determining the extent of platform crowding
Maximum height of mini-platform ATR*	0.56 m
Yellow Tactile attention indicators Tile at Platform Edge	0.61 m
SLOPES	
Island platform cross	2% maximum
Side platforms	Drain away from the tracks
Where platforms slope longitudinally: <ul style="list-style-type: none"> • Tracks, elevator floor, stair enclosure and shelter 	1% maximum

buildings shall be raised <ul style="list-style-type: none"> • Transitionally adjusted at door locations to prevent water entry 	
CLEARANCES	
Minimum horizontal (from track CL)*	2.55 m
Minimum vertical clearance (ATR)—refer to GO Transit Track Standards	6.7 m
Lateral clearance from centre line of track to mini-platforms	1.98 m
Lateral clearance to major and elevated platform structures, centre line of track to canopies, roof overhangs, etc.	3.35 m
Tunnel (pedestrian underpass) clearance, top of tunnel roof membrane overlay to underside of rail, minimum approximately	0.8 m
Important: Additional pavement markings and signage are required for reduced platform clearances (Refer Static Signage Manual)	
* Refer to GO Transit Track Standards for precise track clearances	

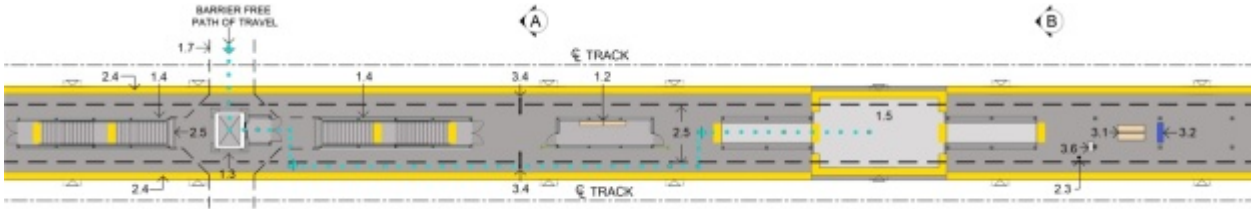

Figure 4: Typical Rail Platform Configuration

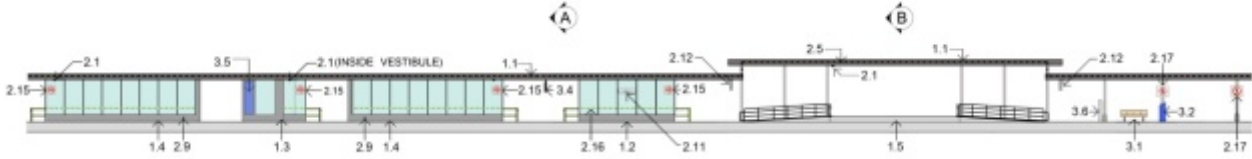

Figure 5: Typical Rail Platform Elevation

LEGEND		
1.1 Continuous Platform Canopy	2.3 Snowmelt System w/ Platform Sensors	2.13 Accessibility Signage
1.2 Integrated Platform Shelter		2.14 Amenity Signage

1.3 Elevator and Vestibule	2.4 Detectible Platform Edge Tile	2.15 Regulatory Signage
1.4 Stair Access and Vestibule	2.5 Platform/Canopy/Raceway	3.1 Platform Bench / Seating
1.5 Mini Platform	2.6 Corridor Raceways (TBD)	3.2 Waste Containers
1.6 Platform Lighting (not shown)	2.7 Drainage (not shown)	3.3 Information Board
1.7 Tunnels	2.8 IT Node/Cluster Infrastructure (not shown)	3.4 Platform Digital Monitors
1.8 At Grade Pedestrian Crossings (not shown)	2.9 Hose Bib	3.5 Advertising (TBD)
1.9 Pedestrian Bridges (not shown)	2.10 Fencing (Not Shown)	3.6 Two Way Communication Devices
1.10 Poles (PA and CCTV-not shown)	2.11 Platform Sign ID	3.7 Wi-Fi (not shown)
1.11 Ramps (not shown)	2.12 Directional / Way finding Signs	3.8 Ladder Tie-off points
2.1 CCTV	2.16 Safety Signage	3.9 Fall restraint
2.2 PA (not shown)	2.17 Warning Signage	
	2.18 Operational Signs	



Figure 6: Typical Rail Platform Elevation - Section A

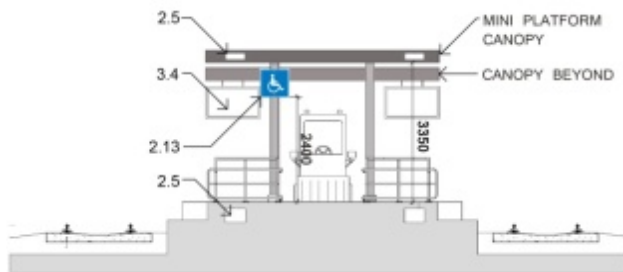

Figure 7: Typical Rail Platform Elevation - Section B

5.2.2 Rail Platform Canopies

Canopies on all rail platforms with integrated shelters and accesses such as elevator and stair enclosures and related amenities shall be provided.

The canopy shall be continuous and should extend to provide maximum coverage (at least 85% of platform length) over the rail platforms.

Canopies shall contain two (2) separate raceways along the full length - one for data, the other for power.

Vertical clearance from top of platform / mini platform to underside of lowest point of canopy shall be

3350mm. The underside of canopy height shall be determined such as to accommodate digital screens suspended from the underside of canopy; ensuring adequate weather protection below canopy and maintaining all horizontal and vertical clearances including a minimum vertical clearance of 2440 mm below all obstructions (including digital signage) for snow clearing and other equipment.

Min. 400mm high concrete pier shall be provided at each support column.

Integrate canopy lighting and other fixtures and amenities such as CCTV, digital signage etc in the canopy ceiling structure.

5.2.3 Rail Platform Access–Tunnels/Ramps/Stairs

Provide a network of barrier-free pedestrian pathways that connects all of the station components to facilitate easy intermodal transit connections.

Connect the station site with adjacent communities via sidewalks, local pathways, or bridges to maximize the pedestrian access to the site and minimize walking distances.

Provide direct pedestrian paths, continuous from the closest local road to at least two of the barrier-free platform access points.

When side platforms are used, provide direct walk on platform paths to maximize access to each platform.

At least one barrier-free rail platform access must be as close as possible to the mini-platform.

Connect one of the rail access tunnels with the station building to provide additional convenience and customer service.

Consider whether the tunnels or bridges connecting to the platforms can also act as barrier-free community connection points on either side of the tracks. If so, ensure each community connection point can remain open when the station needs to be closed.

Platform access shall be visually discernible from site access points to encourage intuitive site navigation to the rail platform.

Provide redundant means of barrier-free access to island platforms by means of two elevators.

This section covers platform access structures including but not limited to:

- Pedestrian Tunnels
- Stairs and Stair enclosures
- Ramps
- Elevators
- Bridges and Pedestrian Overpasses
- At Grade Pedestrian Crossings

5.2.3.1 Rail Platform Stairs and Enclosures

Stair systems not only provide a means of access and egress to and from rail platforms, but also provide means of vertical travel for many people with disabilities, children, seniors, parents with strollers etc.

Stairs shall be/have:

- Easy to find
- Clearly identified with wayfinding

- Located near the major circulations routes
- Offset from the direct route of travel so that they are not a hazard
- Uniform riser heights and tread depths
- Enclosed
- Nosings, handrails, landings, etc. and all other regulatory and barrier free requirements

5.2.3.2 Rail Platform Stair Design Requirements

Table 2: Rail Platform Stair Design Requirements

Criteria	Specifications
Walls	Fully glazed, clear, fully-tempered, designed for local wind loads, and high speed train turbulence
Photoluminescent Strips on Walls	<ul style="list-style-type: none"> • Surface mounted at 300 mm above stair nosing's and landings • Installed continuously along entire length of stairwell wall transitioning in a continuous manner at tunnel level
Stairwell Openings	Extended across tunnels for day-lighting and to reduce the apparent tunnel lengths
Handrails	<ul style="list-style-type: none"> • Stair centre handrails shall terminate at landings to permit crossover. • Material, anchorage and fittings = stainless steel or rust resistant finish
Stair Enclosures	Stair enclosures can be stand alone or combined with elevator enclosures, where applicable
Floor Elevation	Floor elevation to be set to provide positive slope from the doors to the platform
Tactile Attention Indicators	<ul style="list-style-type: none"> • At each landing, extended full width of the stair • Depth of 610 mm (24 in) commencing one tread depth from the edge • Color and texture contrasted with the adjacent surfaces
Floor	Concrete floor, broom finished, sealed
Wall Base	<ul style="list-style-type: none"> • Concrete wall base, to be sandblasted finish, and sealed, no paint • Base shall be 600 mm high (minimum) above the rail platform • Top of the base shall slope on the exterior as a sill, away from the glazing
Enclosure Structure	<ul style="list-style-type: none"> • Fully glazed enclosures with stainless steel framing system

	<ul style="list-style-type: none"> • Frameless with silicone butt-joint glazing, with top and bottom stainless steel glazing channels • Contained within the building envelope • All exposed structural steel framing, including all anchors and fasteners, shall be non-corrosive • Provide appropriate protective coatings or cover plates as required
Cladding	Designed to minimum 1.0 kPa Reference Wind Pressure, with appropriate gust factor and wind pressure coefficients applied to the railway platform.
Guardrails	<ul style="list-style-type: none"> • Stainless steel guardrails shall be provided behind the window walls of stair and elevator wells, for safety in the event of glass breakage • Height of guardrails: to code minimum above platform level • Space for window washing shall be provided between columns/guardrails and glazing
Conduits and Wiring	<ul style="list-style-type: none"> • Both vertical and horizontal wiring conduits shall be concealed and integrated with the structure

5.2.4 Elevators

The requirements do not constitute a project specification. Each project shall have its own specification based upon the GO Master Elevator Performance Specification.

Variance requests shall be supported by an explanation of the reason for the deviation and detailed information on the proposed alternative.

Key design objectives for vertical transportation include:

- Highest degree of safety and security
- Functionality for universal accessibility
- Service reliability
- Convenient operations and maintenance
- Non-proprietary tools, equipment, and knowledge

Important: Refer to Metrolinx Standard Elevator Performance Specification 22 01 52 for details.

Refer to GO Standard Drawings for the Elevator Cab Button configuration.

5.2.4.1 Configuration

- GO Transit Elevators shall be Machine-Room-Less (MRL) Elevator type
- Generator standby power shall be provided to permit continued operation of the elevator(s)
- All electric elevators shall be provided with their own back-up battery power system
- All elevators shall be provided with battery powered emergency lighting
- Barrier-free, “flow through” configuration

- Elevator shaft, car enclosure and entrance doors shall be constructed with the maximum amount of glazing
- All serviceable equipment, not directly connected to elevator operation, to be serviceable from the exterior of the shaft.

5.2.4.2 Communications

- All elevators shall have CCTV camera mounted inside elevator cab
- Camera mounted in vestibules and lobbies shall view inside and outside of each elevator at each level where possible
- All elevators shall have a two-way emergency call system

5.2.4.3 Heating

- Fan forced heater with built-in thermostat
- Heat Pump with hyper heating capability down to -25°C, ducted type and located outside the hoistway

5.2.4.4 Ventilation or Air Conditioning

- Air conditioning via Heat Pump with low ambient cooling
- All elevators shall be provide with two speed ventilation fans shall be supplied with HVAC systems

5.2.4.5 Floor Grille

- Constructed from stainless steel and shall be designed for cleanout by one person, unaided

5.2.4.6 Elevator Numbering Convention

- Elevators north of the tracks shall be assigned numbers first (if not applicable, east side of track shall be first)
- Elevators serving platforms shall be numbered in a sequence following platform numbers being served (i.e. platform one first, followed by subsequent platforms)
- Elevator groups serving a parking structure to be numbered in one sequence

5.2.5 Bridges and Overpasses

5.2.5.1 Open Overpasses

Open overpasses shall not have solid guards.

5.2.5.2 Enclosed Overpasses

- Enclosed overpasses and stairs shall have windows/skylights, including at the ends
- Overpasses connecting platforms shall have unobstructed interior barrier-free routes and turn-around spaces
- Corridors shall be free of overhead and protrusion hazards
- Stair center handrails shall terminate at landings to permit crossover

- Maintenance access is to be provided around the bridge in the form of a catwalk or similar structure

5.2.5.3 Pedestrian Bridges

Pedestrian bridges over tracks shall be single-span structures with supports beyond the operating right-of-way, to the approval of the Railway. Intermediate supports are not allowed. Pedestrian bridges connecting platforms shall have unobstructed interior barrier-free routes and turn-around spaces. Corridors shall be free from protruding hazards.

5.2.5.4 Bridges at Public Thoroughfares

Bridges at public thoroughfares may have intermediate supports, subject to the approval of the authority having jurisdiction.

5.2.5.5 Bridge Structure

Where pedestrian overpasses over the ROW have stairs/elevators down to an island platform, the bridge structure shall be cable-stayed to uphold the bridge in case of derailment.

5.3 Bus Loops

- Bus Loops shall provide separate access for bus, segregated from other vehicular, bicycle and pedestrian traffic
- Decorative Fencing and / or Landscaping is to be used to control pedestrian traffic and limit pedestrian access through the bus loop
- Bus access and egress must allow clearances necessary to accommodate coaches
- When designing GO facilities, GO vehicles should govern the design. MCI model shall be used for bus length and width, and the double deck coach shall govern the height clearance
- Passenger waiting bus platform shall be hard, level materials
- Concrete Curbs to be painted yellow (top and side) along the entire length of the bus loop
- Refer to Metrolinx Standard Drawings Bus Bay Requirements for straight and sawtooth platform details
- The vertical clearance height between driveway pavement and underside of overhead structures shall be 5.3 m minimum in any bus travel area
- Overhead canopies, or other roof assemblies, shall be set back 2.0 m minimum from the face of the curb at bus platforms
- The supporting structure of a canopy, or any other structure, shall have a minimum horizontal clearance of 3.0 m from the face of curb at bus platforms. The horizontal clearances are set to allow for wheelchair lift deployment
- The bus platform curb shall be 150 mm above the bus driveway pavement level

5.3.1 Bus Loop Configuration Traffic Flow

The configuration for a bus loop is to be selected based on-site constraints and optimal traffic flow patterns (vehicle, cyclists, local services, and connections). The following configurations provide standard requirements and details for each of these options. Refer to the Bus Loop Configuration and

Traffic Flow figures for examples of each.

- Figure D-11: Linear Configuration–Linear Traffic Flow (Preferred)
- Figure D-12: Island Configuration–Clockwise Traffic Flow
- Figure D-13: Teardrop Configuration–Counter-Clockwise Traffic Flow
- Figure D-14: Bi-Directional Configuration–Clockwise and Clockwise Traffic Flow

5.3.1.1 Linear Configuration–Linear Traffic Flow (Preferred)

The linear configuration has a platform along the passenger side of the bus loop where passengers have access to the bus. In linear bus loops, buses follow a linear flow of traffic to circulate the loop.

Proceed to Island Configuration (B) if:

- Anticipate significant volume of bus service (both GO and Municipal) as linear loops have limited space for platform expansion and accessibility concerns (lengthy distances) for bus to bus transfers.

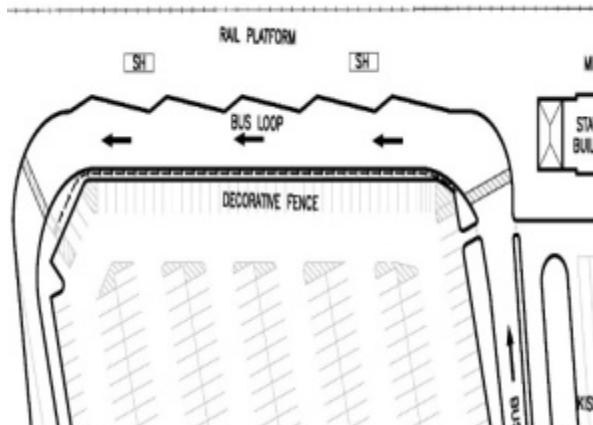

Figure 8: A. Linear Bus Loop Configuration Linear Traffic Flow

5.3.1.2 Island Configuration–Clockwise Traffic Flow

- Effective at bus terminals and stations with bus to bus (GO and local transit) transfers
- At stations with limited real estate
- At stations with multiple points of access / egress to municipal roads allowing for controlled and predictable movements within the loop

Proceed to Teardrop (C) Configuration if:

- Anticipate significant level of bus service at location as islands have limited room for platform expansion
- Anticipate safety concerns from clockwise traffic flow and limited access / egress points (bus route crosses at throat of loop and passengers cross loop to access platforms)

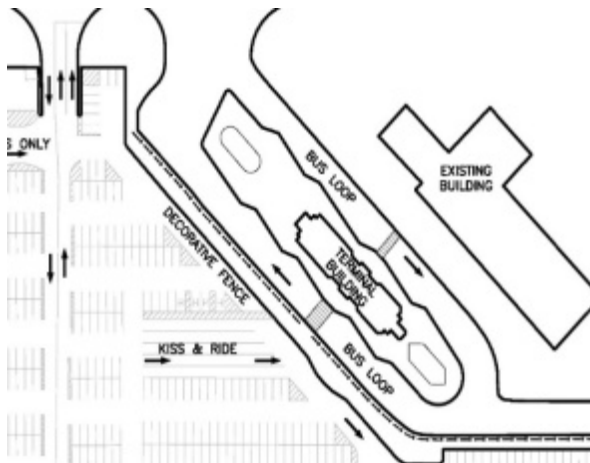

(Kiss & Ride) is PUDO (Passenger Pick-Up and Drop-Off).

Figure 9: B. Island Bus Loop Configuration Clockwise Traffic Flow

5.3.1.3 Teardrop Configuration–Counter-Clockwise Traffic Flow

- At stations with a high volume of GO Bus service
- At stations anticipating future expansion
- At stations with high bus-to-rail transfers
- Anticipate safety concerns resulting from clockwise flow of traffic (bus routes do not cross at throat of loop and platforms are on perimeter)
- No real estate restrictions

Proceed to Bi-Directional Configuration (D) if:

- Largest stations or bus terminals with highest volumes of GO and Local bus service

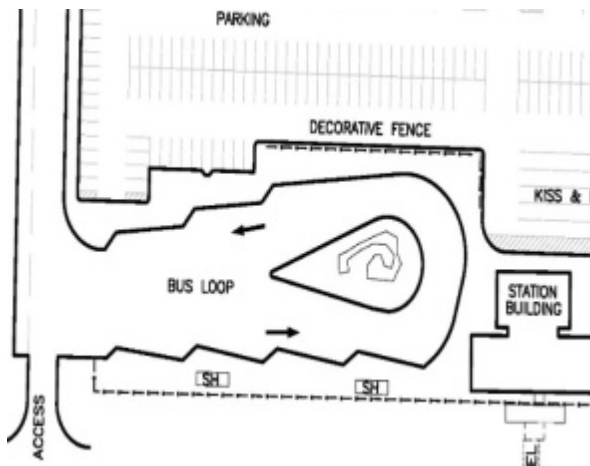

(Kiss & Ride) is PUDO (Passenger Pick-Up and Drop-Off).

Figure 10: C. Teardrop Bus Loop Configuration Counter Clockwise Traffic Flow

5.3.1.4 Bi-Directional Configuration–Clockwise and Counter-Clockwise Traffic Flow

- Effective at high volume stations and bus terminals with both GO bus and local bus
- Availability of tunnels to connect pedestrians to island platforms without crossing bus loops
- No real estate restrictions, although this configuration offers an efficient use of real estate

(Kiss & Ride) is PUDO (Passenger Pick-Up and Drop-Off).



Figure 11: D. Bi-Directional Bus Loop Configuration and Traffic Flow

5.3.2 Bus Radii

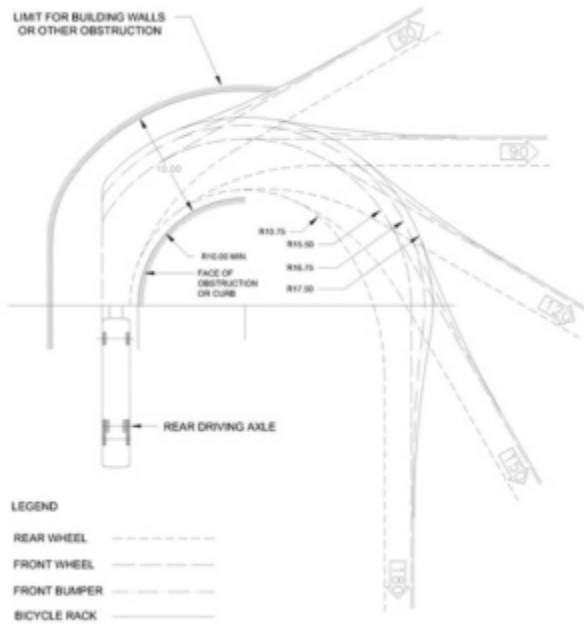

Figure 12: Bus Radii Turning Template

The following criteria shall be considered when using the turning template:

- Design Vehicle GO Bus Model MCI D4500

- Bus speed–15 km/h
- Bicycle rack deployed
- Steering wheel turned all of the way to the Right stop
- Lateral clearance of 500 mm
- Bus turn does not begin until the rear wheels have reached the Tangent–Curve (TC) point of the inside face of curb or other obstruction

The design bus turning template shall be used where the operating speed of the bus is low, 15 km/h, and sharp short turns can be made without rider discomfort, for the design of surface features such as: Straight and saw-toothed platforms; Bus bay entrances; Bus loops; Entrance roads; and Bus maintenance and storage facilities.

5.4 Passenger Pick-Up and Drop-Off (PUDO)

Short-term parking facilities for passenger pick-up and drop-off (PUDO) shall be provided at GO Stations. Passenger PUDO facility shall be designed to:

- Be free flowing and give easy access to station entrance and exit.
- Orient vehicle circulation in a direction to eliminate vehicle cross over
- Face the station building or secondary entrance to the platform
- Provide capacity of a minimum 2-3 % of total parking space
- Be a lineal, parallel layout, sized on the basis of passenger loading and vehicle projections, allowing a space 3000 mm wide by 6000 mm long for each vehicle. Where possible, provide more lanes of shorter length to allow for easier vehicles access and exit
- Be visible from enclosed passenger waiting areas
- Accommodate the physical requirements of customers in a mobility aid device
- Have pedestrian movement parallel with the flow of traffic, minimizing the conflict between cars and people
- Include a 3000 mm wide hatched area for lift equipped vehicles. Ensure a barrier-free drop-off zone complete with curb cuts and dedicated loading/unloading area to be located on the right to discharge passengers at the curb or walkway
- Allow physical separation through a 2500 mm, raised curb or landscaped buffer between vehicles and pedestrians
- Taxi Lane shall be part of the PUDO

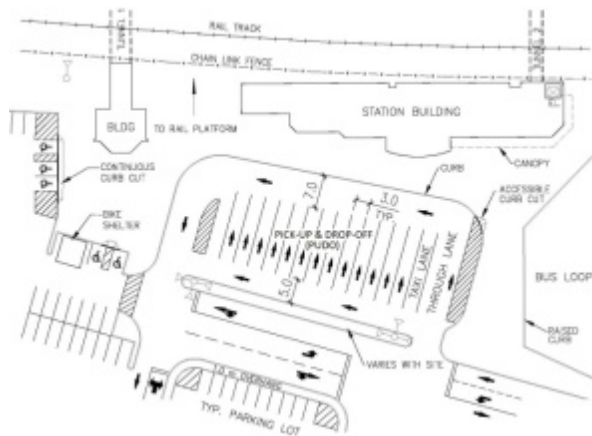

Figure 13: Typical PUDO Configuration

5.5 Pedestrian Connections

5.5.1 Walkways

- Use dedicated and continuous routes, throughout the station and connections to surrounding areas
- Create separation from vehicular traffic, whenever possible
- Make walkways a minimum 1600 mm wide
- When a pedestrian entrance is provided from a recreational trail, provide a clear opening between 850 mm and 1000 mm, whether the entrance includes a gate, bollard, or other barrier
- Raised and constructed of hard and sustainable level materials that are slip resistant
- Smooth with few joint and visually distinct from surrounding areas

5.5.2 Delineated Crosswalks

Shall be installed in conjunction with signs and accessible crosswalk markings provide guidance for pedestrians and alert road users of a designated pedestrian crossing point by defining and delineating paths.

5.6 Vehicular Access & Accommodations

Provide a complete system of vehicular roads and access points that promotes efficient circulation and maintains fluid access and egress to and from local streets.

Maximize the number of vehicular access points, in particular egress lanes, to mitigate the congestion.

Design of vehicular access roads shall passively encourage speed reduction.

Organize large surface parking areas into smaller lots to manage traffic flow, facilitate better site navigation.

Locate parking structures to balance desired direct access to the rail platform.

- Provide barrier-free parking close to the rail platform access and station building

- Access roads = one for 300 parking spaces
- Single lane access roads = 4500 mm wide for single lane one-way traffic
- Two-lane access road = 7000 mm wide
- Three lane access road = 10500 mm wide lane
- Parking lot aisles shall be 7000 mm wide

Important: Parking layouts shall respond to property size and site geometry. Parking structures and surface parking shall be designed as an integral component of the coordinated site plan and architectural theme.

Awkward, irregular gaps in parking layouts shall be filled in wherever possible (eg. bike, scooter parking, etc.).

5.6.1 Parking Stall Design Requirements

Table 3: Parking Stall Requirements

Criteria	Specifications
Standard parking stalls	2500 mm wide and 5500 mm long
Stalls abutting curbs	4500 mm long with a 1000 mm allowance for vehicle overhang
Parallel parking stalls	3000 mm wide x 7000 mm long
Vehicular overhang	1000 mm
Sign posts	Shall be provided at parking row locations to indicate tow away zones (refer to the Static Signage Standards for details)

5.6.2 Multi-Level Parking Garages

The basic requirements for a Multi-Level Parking Garage are:

- Efficient traffic flow patterns for access and egress based on GO passenger patterns
- Functional Parking geometries with consideration for size, height, and turning radius of automobiles
- Efficient internal pedestrian & vehicular flow with redundant access / egress points
- Consideration for pedestrian and bicycle access
- Incorporate CPTED (Crime Prevention Through Environmental Design) principles
- Emergency response and access
- Accommodation for communication and electrical other related equipment
- Appropriate Wayfinding Measures; Signage; Building Identification and Corporate Branding
- Incorporation of Sustainable Design Principles, energy efficient lighting and other proven 'green' initiatives and/or technologies to mitigate potential environmental impacts

- Accommodation for salt protection and safe service and maintenance activities / equipment and user friendly, easily operated building design
- Include space counting system with a UPS for car counting system

5.6.2.1 Access-Entry and Exit

- Adequate queuing accommodation/space
- Internal circulation patterns shall minimize vehicular and pedestrian conflict, minimize travel distances, conflicting movements, and number of turn, and avoid congestion
- All vehicular ramps shall be provided with transition zones at the top and bottom of the ramp at a minimum

5.6.2.2 Snow Management

- Allow easy snow removal and minimize any damage from its operations and chemical treatment applications
- Architectural elements such as spandrel or enclosure panels shall minimize snow drifting and wind
- Exterior ramps and stairway areas to be provided with hydronic or electric resistance snow melting embedded below the traffic surface
- In all areas, floor drains and floors shall be configured to prevent ponding and allow for quick and easy drainage

5.6.2.3 Exterior Elevation

- Exhibit a high level of architecture detail such as decorative screens, overhead canopies over pedestrian walkways that establish a comfortable and well-proportioned human scale
- Satisfy building code requirements of fall arrest and to ensure that the over- all building envelope meets the open air requirements
- Maintenance, bird control, and lighting shall be considered in the exterior finishes and configuration. See detailed requirements in F.5 Finishes and Materials section of the DRM.

5.6.2.4 Finishes

- All traffic surfaces will be capable of taking paint for pavement markings
- All exposed structural steel structures will be hot dip galvanized
- All exposed Mechanical and Electrical systems to be painted
- Improved surface friction at entrance locations using a variety of techniques such as (but not limited to) grooves, heated ramps, additional drainage, shall be used that will preserve contact between the vehicle and the inclined surface
- Include a gritty material into the surface sealer with a suitable balance of micro and macro textured granules to increase the friction coefficient of vehicle tires on concrete surface
- Ramps exposed to exterior elements will require increased texture, provisions for snow melting systems, and a chevron pattern spaced maximum 30 mm apart and 5 mm deep to help with drainage

5.6.2.5 Electrical

- Electrical and communications rooms are not to be below grade
- Main Electrical and communication rooms shall be located next to each other.
- Emergency Backup Power Systems shall be provided
- Service entrance distribution panel board, transformers, transfer switches, contactors and controls, UPS and branch circuit panel boards shall be located in the electrical room
- Provide access controls i.e. fob access and keypad to the Electrical, Communications and Hub rooms
- Energy Management System/ Smart Panels (smart panels have a main breaker which is capable of providing a network IP address giving current readings at each circuit in the panel) shall provide the most flexible control system available: multi-level lighting, occupancy lighting changes, light harvesting, programmable circuit control, IP addressable, open architecture (backnet / modbus compliant)
- For all receptacles and plugs refer to the Metrolinx Standard Receptacles and Plugs Specification 26 27 26
- All electrical components, panels, ducts are to be mounted on standoffs
- No direct connections to the wall or ceilings are permitted
- LED lighting to be used in all areas refer to Metrolinx Lighting and Control Specification 26 50 00
- For further information, refer to Section F and the GO Standard Drawings and Specifications.

5.6.2.6 Mechanical Systems

Important: All pipes and mechanical fixtures shall be designed to be corrosion free (no Copper type M is permitted).

- Mechanical systems to be designed without confined spaces
- Connect sanitary sewer to level 1 drainage
- If not possible, provide duplex epoxy coated sanitary sump pump with:
 - 2 independent seal assemblies
 - Guide bars
 - Four float level control system
 - Lifting equipment including lifting davit
 - Chain hoist and hook
 - Lifting de- vice
 - Gas tight access frame
- Self-opening cover complete with piston kit and safety grid cover shall be traffic bearing where needed and completely assembled stainless steel
- There shall be no need for personnel to enter the wet well to service the pumps. Utility water meter to municipal standards shall be provided with 3 valve by-pass arrangement
- Accommodate water service on every level

- Provide exterior non-freeze water hydrants evenly spaced along the perimeter
- Incorporate heat tracing
- Provide heavy duty parking area drains with accessible cleanout, duty grate and sediment buckets

5.6.2.7 Service and Maintenance Area

A designated storage area in the parking structure shall be provided to accommodate service equipment, sweeper storage, and tools in a secure location.

The room(s) shall be accessed by a double leaf Hollow Metal (HM) door and the doors shall not open onto vehicular traffic; a concrete apron shall be provided with bollards

Service rooms shall contain, but not be limited to:

- Sprinklers
- Water valves
- Switches
- Mechanisms

5.6.2.8 Signage

Important: For signage design requirements at parking garages refer the GO Standard Parking Garage Signage Requirements

5.7 “Green Zone”

The “Green Zone” is part of the Smart Commute program that identifies a variety of modal options that promote sustainable station access such as cycling, local service integration, carpool, electric vehicles, walking, etc.

5.7.1 Motorcycle/Scooter Parking

Motorcycle/Scooter parking is located in parking areas that would otherwise not be useable for standard vehicular parking. Each parking space shall be a minimum of 1500 mm wide by 2500 mm long. Individual stalls are not required

The parking area shall have a concrete base with steel reinforcing.

A designated dismount area is to be provided.

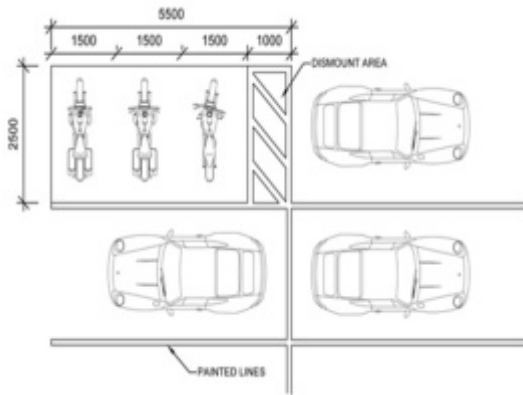

Figure 14: Motorcycle End of Parking Row Configuration

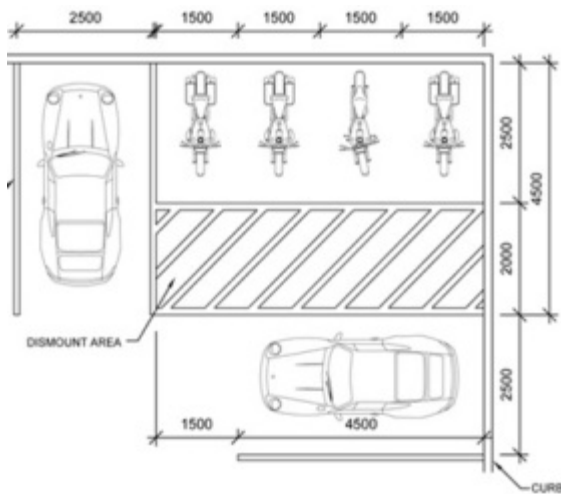

Figure 15: Motorcycle Corner/Dead Space Configuration

5.7.2 Carpool to GO Parking

- 1% of total parking spaces in proximity to barrier free parking
- Signage shall be provided at each carpool parking space location (Refer to Figure: Carpool to GO Stall ID Marker in Static Signage Catalogue)

5.7.3 EV Charging Station

- EV charging stations to be installed as directed by Metrolinx to support fleet operations.

5.8 Pavement and Line Markings

Asphaltic and concrete pavement shall be in accordance with Ontario Provincial Standards.

5.8.1 Asphalt Mixture

Pavement Design shall be based on the Geotechnical Consultant's recommendations. However, the minimum asphalt thickness shall be:

- Car and emergency vehicle access routes: 40 mm HL3 on 80 mm HL8;
- Parking: 40 mm HL3 on 40 mm HL8;
- Bus Platforms: 50 mm HL3, HL3A, or concrete;
- Sealed Rail Platforms: 50 mm HL3A; and
- Other miscellaneous items: 40 mm HL3 on granular.

5.8.2 Concrete Paving

- Concrete walkways: Ontario Provincial Standards criteria to govern.
- Concrete bus access routes: per Geotechnical and Structural Engineers' design.

5.8.3 Slopes

Table 4: Slopes

Slopes				
Location	Longitudinal		Cross Slopes	
	Pref.	Max	Pref.	Max
Walks	0%	4%	OPSD	OPSD
Platforms (Rail & Bus)	0%	1% Note 1	1%	2%
Parking Lots	1%	3%	1%	3%
Fire Access Routes	Slopes to suit OBC fire access route criteria.			

Note 1:

Design and layout are to be in accordance with details shown on Figures. Material Standards: OPSS 532. For pavement areas interfacing with public thoroughfares, design shall be in accordance with the current MTO Manual of Uniform Traffic Control Devices and the Manual of Uniform Traffic Control Devices of Canada.

Table 5: Line Markings

Line Marking	
<i>Location</i>	<i>Colour</i>
Parking stalls, parking restricted areas and islands	Yellow
Directional dividing lines	Yellow
Rail Platform safety line	Yellow (TWSI)
Lane lines, stop lines and arrows	Yellow
Pedestrian crosswalk lines	Yellow

Table 6: Line Marking (Parking Structures Only)

Line Marking (Parking Structures Only)	
<i>Location</i>	<i>Colour</i>
Parking stalls, parking restricted areas and islands	Yellow
Directional dividing lines	White with reflectorizing glass beads
Lane lines, stop lines and arrows	White with reflectorizing glass beads
Lane lines, stop lines and arrows	White with reflectorizing glass beads
Pedestrian crosswalk lines	White with reflectorizing glass beads
Barrier Free Parking Symbol	White and Blue (Pantone 300)

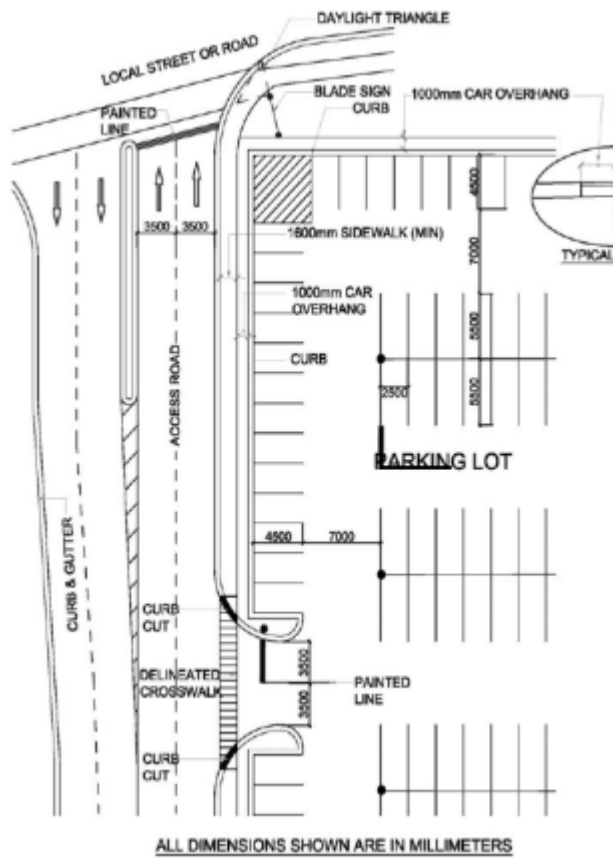

Figure 16: Vehicular Parking Diagram

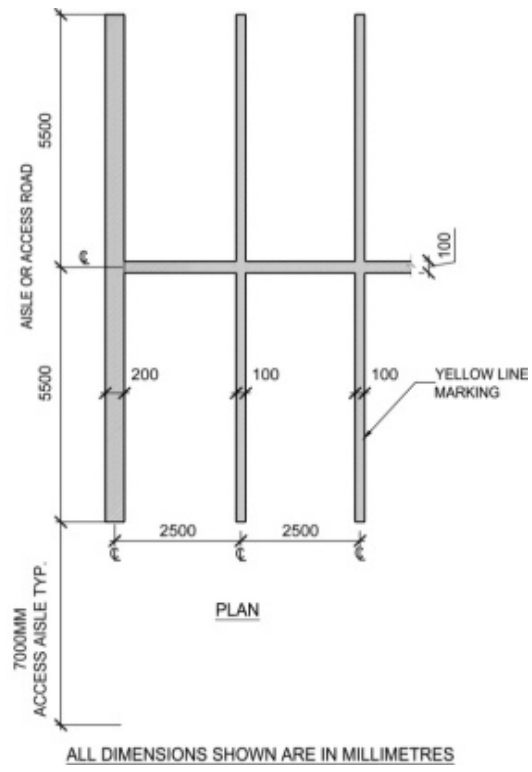

Figure 17: Vehicular Parking Diagram

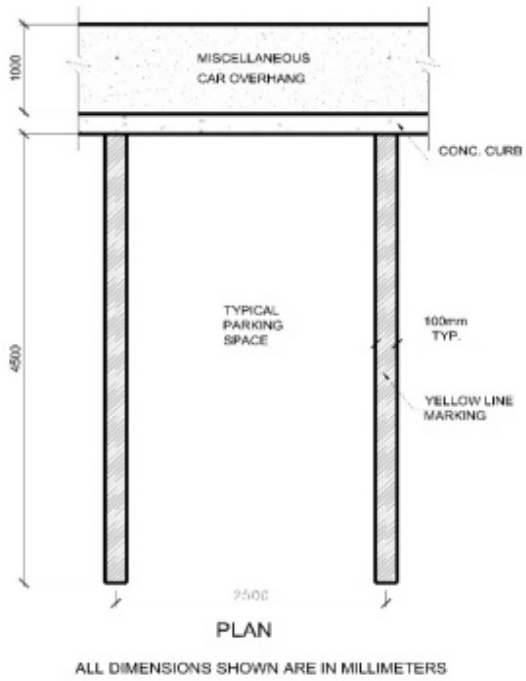

Figure 18: Line Marking – Row Parking Stalls

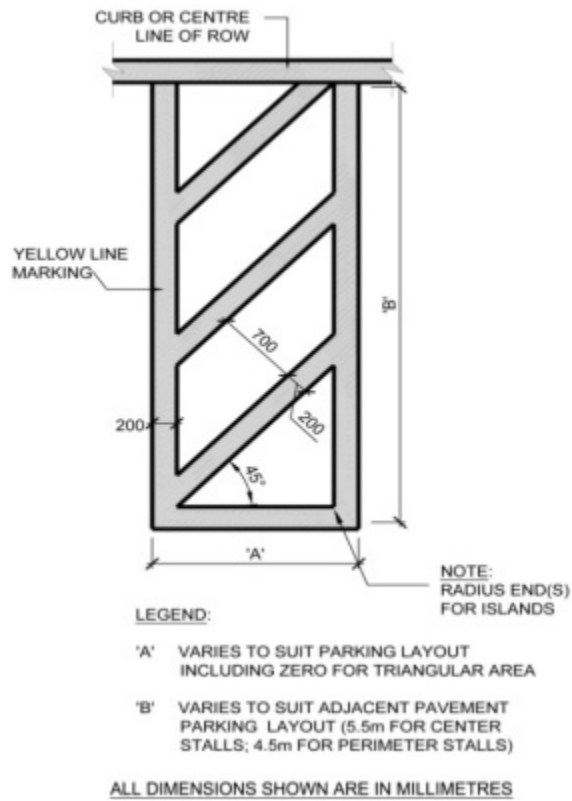

Figure 19: Hatched Parking Area Configuration

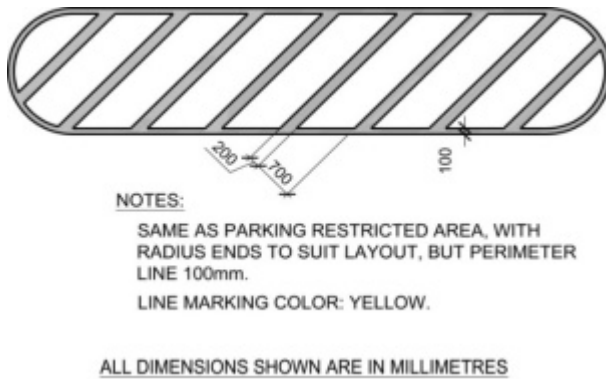

Figure 20: Line Marking for Islands

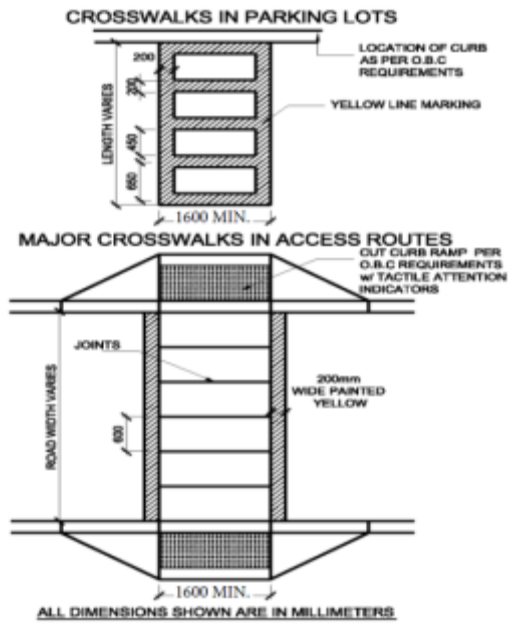
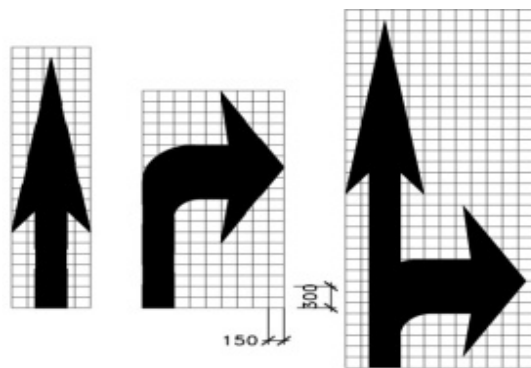

Figure 21: Crosswalks in Parking Lots and Major Crosswalks on Access Routes



AS PLACED ON THE PAVEMENT



AS SEEN BY THE MOTORIST

NOTES: GRID MODULE IS 150mmx150mm
COLOR - LINE MARKING: YELLOW

Figure 22: Line Marking – Pavement Arrows

5.9 Park and Ride Lots

Park & Ride lots are intermodal transfer facilities. They provide a location for travelers to transfer between the auto mode and transit or between the single occupant vehicle (SOV) and other higher occupancy vehicle (HOV or carpool) modes.

All requirements from applicable sections apply, specifically:

- Site Plan Layout & Organization
- Bus Loops
- Vehicular Access and Accommodations

Park & Ride Lots are typically on MTO property and operated by GO Transit. The lots are serviced by GO transit and may be used by other local and regional carriers.

Car Pool lots are owned by the regions or MTO, whose standards govern. They may be serviced by GO Transit and other transit agencies.

5.10 At Grade Pedestrian Crossings

Important: Where at grade rail pedestrian crossing is required, in addition to adhering to Transport Canada regulations, approval shall be obtained from Railway Corridors and System Safety at Metrolinx.

Table 7: At Grade Pedestrian Crossings

Element	Design Requirement
Flangeway Gap	<ul style="list-style-type: none"> • The flangeway width may not be less than 65 mm and shall not exceed 75 mm • Extend rail seal and taper asphalt at least 254 mm beyond edge of crossing surface • Material: Use rubber rail seal to match the rail size and profile • Use 3048 mm lengths and specify a flangeway width of "2 ½ inches"
Crossing Width	<ul style="list-style-type: none"> • The total crossing width including the 254 mm tapered shoulder of the crossing shall be a minimum of 3048 mm • The total crossing surface width, level from shoulder to shoulder, shall be a minimum of 2540 mm • The travelled or usable crossing surface width, which represents the minimum clearance distance for two wheel chairs to pass between the pavement marking lines, shall be no less than 1829 mm • The width of the approaching walkway, where there is one, shall be designed so that the crossing width shall extend a minimum of 500 mm beyond the shoulder of the approaching walkway
Crossing Surface	<ul style="list-style-type: none"> • Material: Asphalt 150-200 mm HL3A to match top of rail • Geotextile to be placed directly on ties and ballast and must continue

	<p>to top of rubber rail seal</p> <ul style="list-style-type: none"> • Construction tolerance between crossing surface and top of rail–3mm • Grade between rails: match elevations of top of rail
Crossing Approach	<p>Material:</p> <ul style="list-style-type: none"> • Asphalt 200 mm HL3A (typical) • Subgrade: 150 mm granular "A" • Gradient (Accessibility Standard) • The gradient shall not exceed a ratio of 1:20 (5%) • A gradient exceeding 1:20 (5%) would require the approach to be designed as a ramp <p>In accordance with the Ontario Building Code, ramps can have a maximum gradient of 1:12 (8.3%).</p> <p>Furthermore, ramps require a handrail on both sides; therefore, this application would only be possible outside of the clearance envelope.</p> <p>Crossing approach shall be detectable at the boundary between the platform and the crossing to identify a safe stopping location outside of the clearance envelope.</p>
Crossing Location	<p>Where a train will not occupy the crossing during a regular Station stop the inside edge of the crossing shall be located no less than: 6 metres from the front of the facing cab-car.</p> <ul style="list-style-type: none"> • Fencing shall be installed to prevent pedestrians from crossing the tracks between a locomotive/cab-car and a designated level crossing • Rail joints shall not be located within the crossing
Guide Rails	<p>Guide rails are required for gate application only for the purposes of:</p> <ul style="list-style-type: none"> • Providing a means to close-off the counter weights and mechanism, thereby providing a protective barrier for pedestrians • Guiding pedestrians and closing off access to the corridor when the gates are down, i.e. the gate arm shall "slot" into the guide rails
Z-Barrier (Maze Barrier) (non-accessibility standard)	<p>Consider specific application depending on approach, e.g. not envisaged on platforms but may have a use on the parking side of the tracks where there is a large/lengthy approach and e.g. poor sightlines. The application would be used to slow down and control pedestrians so as to focus direction (sightlines) and attention to the crossing, or to force cyclists to dismount e.g. when using steps on approach.</p> <p>The following shall be considered for application only if required as per Transport Canada RTD-10 Technical Standards Manual:</p> <ul style="list-style-type: none"> • Flashing lights and bell: Only to be considered if maximum permissible train speed exceeds 60 mph

	<ul style="list-style-type: none"> • The maximum permissible train speed exceeds 15 mph and there are two or more tracks at the grade crossing where trains may be passing one another • Specification: Mechanical or electrical bell as per AREMA <p>Gates:</p> <ul style="list-style-type: none"> • Only to be considered where grade crossing warning systems are installed and the maximum permissible train speed is 50 mph or more • There are two or more tracks where trains may be passing one another • When the sightlines along the railway right of way for a pedestrian stopped at the grade crossing are not at least equal to the minimum requirements as per RTD-10 Specification • Short arm gates as per AREMA <p>Active Warning Devices as above will require standard control equipment as per AREMA, e.g., solid state crossing controller, event recorder, track circuits, bungalow, batteries and chargers, etc. and installation shall conform to AREMA and RTD-10.</p>
--	--

5.11 Landscaping & Civil Works

The landscaping requirements respond to both the urban design and environmental challenges associated with various surfaces at GO facilities.

Landscaping for all surfaces involves planting trees and plants, providing good quality soil and generous landscaped areas, enhancing pedestrian and cycling infrastructure, managing stormwater on-site, reducing the urban heat island effect, and using sustainable materials and technologies.

Landscaping design shall reflect the following objectives:

- Maximize shade along pedestrian routes, and for stormwater retention
- Consolidate soft landscaping areas to support plant growth and keep maintenance requirements to a minimum
- Mitigate the urban heat island effect
- Manage stormwater quality and quantity on site
- Incorporate sustainable materials and technologies
- Where possible, collect water for plant irrigation
- For edges not adjacent to the public realm, provide soft landscaping with variety of deciduous and coniferous trees and plantings. Include bio-retention or other stormwater management systems as appropriate
- When not feasible to provide areas of landscaping, planters shall be introduced to enhance the appearance when approaching site, around buildings and waiting areas
- The landscaped design shall incorporate CPTED principles.

5.11.1 Plant Material

Select plant material that is suitable to the growing environment of the site:

- Use species (native or non-native) that are hardy, drought and salt-tolerant, and resistant to the stresses of compacted soils and weather exposure
- Avoid planting invasive species near ravines and other natural areas
- Avoid monocultures which can be susceptible to disease
- Consider sun, shade and irrigation requirements when choosing plants
- Incorporate a variety of deciduous and coniferous trees and shrubs for year-round interest, texture, shape and seasonal colour
- Boulders excavated from sites shall be retained and incorporated into the landscape design; and
- Wood chip, brick chip, gravel and rock groundscaping shall have geotextile underlays to eliminate weeds, and shall be contained by edge strips. Such a groundscaping under fences shall extend 300 mm on each side of a fence
- Groundscaping must be provided under roof overhangs, where adjacent to landscaped areas
- Gas meters, transformers, etc. in landscaped areas shall have patio stones or equal service access pathway

5.11.1.1 General Plant Specifications

Install plant material that meets or exceeds the following minimum sizes:

- Coniferous trees 1500 mm ht.
- Deciduous shrubs 600 mm ht.
- Coniferous shrubs 600 mm ht. or spread
- Perennials 2 years container grown
- Where landscaping might impact motorist/ pedestrian sight distance, keep shrubs below 850 mm
- Ensure overhanging branches of trees or shrubs adjacent to pedestrian pathways maintain clear head- room of at least 2100 mm

5.11.1.2 General Soil Quality Specifications

Good quality soil shall consist of a minimum 0.9 m* depth, over and above any required drainage system and/or granular material, of sandy loam soil with the following composition:

- Sand (50%-60%)
- Silt (20%-40%)
- Clay (6%-10%)
- Organic (2%-5%)
- pH = 7.5 or less

Note: In landscaped areas without tree planting, the minimum depth for good quality soil can be reduced to 0.6 m

5.11.2 Islands/Curbs

The use of curbed islands shall be minimized, with line-marked islands preferred. Raised curbs shall be restricted to the perimeter, access/egress, bus loop platforms, and pedestrian walk areas to facilitate traffic flow and control.

Raised islands between access roads and parking or the PUDO shall be a:

- Minimum 2600 mm wide between curb faces
- Include a 1000-mm section for vehicle overhang
- Remaining width shall be used for either pedestrian circulation or landscaping

Incorporate raised islands and soft landscaped buffers within large parking lots to define major vehicle and pedestrian routes and to break up large paved areas.

5.11.3 Fencing

A fencing system is a component of safety and access control systems. Installation of fencing systems shall be conducive to operations and not become a maintenance burden.

All fencing shall include the following characteristics and features, regardless of the intended performance of the fence at a given location (varying only in height). Each fence shall be:

- Secure
- Anti-climb
- Anti-cut
- Vandal-proof
- Highly transparent
- Attractive

5.11.3.1 Types and Application

Fences are required at, but not limited to, the following categories of GO facilities:

- Railway Corridors—refer to Railway Corridors Operational Requirements
- High Risk Facilities—2,400-mm-high security fencing at, but not limited to, the following facilities:
 - Layover yards and sites
 - Electrical sub-stations
 - Fuel yards and tanks
 - Maintenance facilities
- Medium Risk Facilities: Minimum 1800-mm-high security fencing at, but not limited to, the following facilities:
 - Storage and warehouse facilities
 - Signal bungalows
- Low Risk Facilities and Site Components: Knuckles down fencing, no higher than 1200 mm with an attractive appearance and with no vertical protrusions (especially around facilities serving public and transit passengers), at the following facilities:

- Fencing dividing multiple tracks
- Rail side platforms
- Significant grade and elevation change
- Boundary definition as directed by GO
- Bus loops and platforms
- Access control flow
- Ponds, ditches, swales, and high embankments

(Note that condensers and generators adjacent to a station or terminal building shall have decorative fencing and lockable gates.)

5.11.3.2 Gates

- Maintenance access gates shall be a minimum of 2,700-mm-wide, hinged single or double gates
- Sliding gates between tracks shall be a minimum of 2700 mm wide, single, or bi-parting gates
- All gates shall be lockable, single, or double locks if required by the Railway, Hydro, or other users
- Grounding and bonding is required for metal gates
- All gates that require electrical operation shall have local and remote capabilities (addressing access control, CCTV, intercom, data and power requirements)
- Facilities that require a security gate to gain entry shall include an access control system, two-way communication to Metrolinx Security Office and CCTV monitoring of the gate

5.11.4 Site Furnishings

5.11.4.1 Garbage and Recycling Storage Areas

The Consultant shall verify garbage and recycling bin sizing with station, local municipality and/or service provider to validate garbage enclosure dimensions prior to design. At a minimum, garbage enclosures must be large enough to conceal two 6-yard bins.

The following criteria shall be considered when deciding on a location for a garbage enclosure:

- Garbage truck access
- Staff access / proximity to station
- Place on surplus land (land which cannot be used for anything else)
- Keep away from pedestrian paths and waiting areas
- Keep out of direct view when entering the site
- Where required, gates shall be equipped with “No Parking” signage to ensure accessibility is always maintained (for “No Parking” signage please refer to the Static Signage Standards)
- Consultant to verify signage sizing with GO prior to proceeding

5.11.4.2 Exterior Bollards

- Shall be integrated with station and bus terminal area design.

- Bollards shall be approximately 200 mm in diameter and fabricated from 304 grade stainless steel with a satin finish.
- The bollards shall project 1000-1200 mm above grade and set minimum 1200 mm into concrete pier. Bollards shall have a 50 mm contrasting reflective band (or approved equivalent) around the circumference of the bollard at a designated recessed space (to ensure durability), 80 mm below top surface.
- Areas requiring additional safety, such as bus plazas with roll over curbs, shall have 200 mm diameter galvanized steel pipe, concrete filled, and protected with a 304 grade stainless steel cover of minimum 3 mm thickness and two 50 mm contrasting reflective bands around the circumference of the bollard.
- At bus fuel storage areas, rail and bus maintenance facilities etc., provide bollards to protect electrical equipment locations and impact protection to hydrants and any other structures or equipment installed within 2000 mm of vehicle traffic areas
- These bollards shall be 250 mm diameter concrete filled bollards. See Section E – Building Program, Maintenance Facilities requirements for details

5.11.4.3 Interior Bollards

- When located in maintenance facilities shall be 150 mm diameter galvanized steel pipe
- Concrete filled
- Protected with 3 mm minimum thick high density polyethylene 'safety yellow' (or other colour as specified by GO) coloured cover
- The bollards shall project 1000-1200 mm. above finished floor with a minimum of 300mm below grade.
- Cast with welded plate and 4 anchors into concrete slab
- The bollards shall be equipped with pole sleeve covers
- Interior bollards when located in stations and bus terminals shall be 200 mm in diameter and fabricated from 304 grade stainless steel with a satin finish

5.11.4.4 Removable Bollards

- Permanently installed receiver below grade, with a top that is flush with the pavement and a cap to prevent dirt accumulation while the post is removed
- Removable post that can be manually lifted out of the receiver to allow access
- Exposed locking mechanism, with a padlock keyed to the line master
- Dimensions, covers and color schemes shall meet Exterior and Interior Bollard's requirements above

5.11.5 Civil Works

5.11.5.1 Storm Drainage

The design flood criteria for all sites shall comply with the MOE Storm Water Management Practices, Planning and Design Manual, the OPSD and MTO Drainage Manuals, as well as Regional and/or Municipal Storm Water Management requirements. Oil and grit separators and inlet control devices.

Generally surface water flow shall be directed from landscape areas to parking lot catch basins. Catch basins in landscape areas shall be avoided if possible.

5.11.5.2 Catch Basins

Catch basins shall be located upstream of pedestrian crossing areas, and 1500 mm clear of any driveway curb depressions. Grates shall be diagonal type. Catch basins shall not be located in the path of bus wheels, especially in bus loops. Retention ponds and catch basin flow restrictors shall be provided in accordance with stormwater management requirements. Catch basins shall not be located on walkways and/or in front of building doors.

5.11.5.3 Gutter Drainage

Gutter drainage shall be restricted to access roads if required to prevent storm run-off onto adjacent property. Road and gutter gradients shall not exceed Fire Access Route requirements.

5.11.5.4 Ditch Drainage

5.11.5.5 Grading

Grading shall be designed to avoid excessive slopes and shall be integrated with surrounding landforms to provide slope stabilization and positive flows to the drainage system. Where existing landforms, or vegetation, are to be preserved, appropriate protection and construction controls shall be designed.

5.11.5.6 Retaining Wall

The Consultant shall select the optimum permanent retaining method (wood shall not be used for retaining walls). Where concrete retaining walls are in proximity to the public, they shall be sandblasted. Low retaining walls shall be precast concrete units. Gabion walls may be used in non-public areas. Where retaining walls are adjacent to buildings, the material shall be compatible with the architecture.

5.11.5.7 Stormwater Management

Manage rainwater and snowmelt on-site with designs that encourage infiltration, evapotranspiration and water re-use:

- Sustainable materials paving for parking surface, drive aisles, overflow parking, snow storage areas and other hard surfaces in the parking lot
- Provide a planting medium, composed of good quality soil, with a minimum depth of 0.6m and at least 0.9m depth if trees are planted
- Plant trees (if applicable) above grade from ponding areas and clear of stormwater flow
- Ensure that any surface water is fully drained within 48 hours or less
- Use poured in place curbs with cuts for water inlets
- Include a perforated subdrain, check dams and overflow catchbasins as required to manage excess water
- Ensure overland flow routes and stormwater inlets and outlets are clear of debris and snow piling

5.11.5.8 Snow Control

Provision for snow control to reduce snow deposits in unwanted areas shall be employed. Generally, a

vertical barrier will provide protection for a distance equal to 45 degrees projection. A porous barrier will protect for a distance of 10.0 m times the height although, the degree of protection may be reduced

5.11.5.9 Snow Storage

Snow storage areas shall be:

- Identified on the Landscape Plan
- Provide snow storage areas away from public streets and other areas where
- Motorist/pedestrian sight distance and continuous landscape screening is essential
- Sodded areas or portions of landscaped areas may be identified for snow storage with plant material selected accordingly
- Where overflow parking or bio-retention areas are provided, those areas may be used for snow storage
- Hard surfaces areas used for snow storage are encouraged to have sustainable materials to retain snow melt on-site

5.12 Geodetic Reference

5.12.1 Station Geographical Coordinates

For GO Stations, the official geographical coordinates are to be located at the centre of the edge of the mini platform as outlined in figure–Geographical Coordinate Placement at Mini-Platforms.

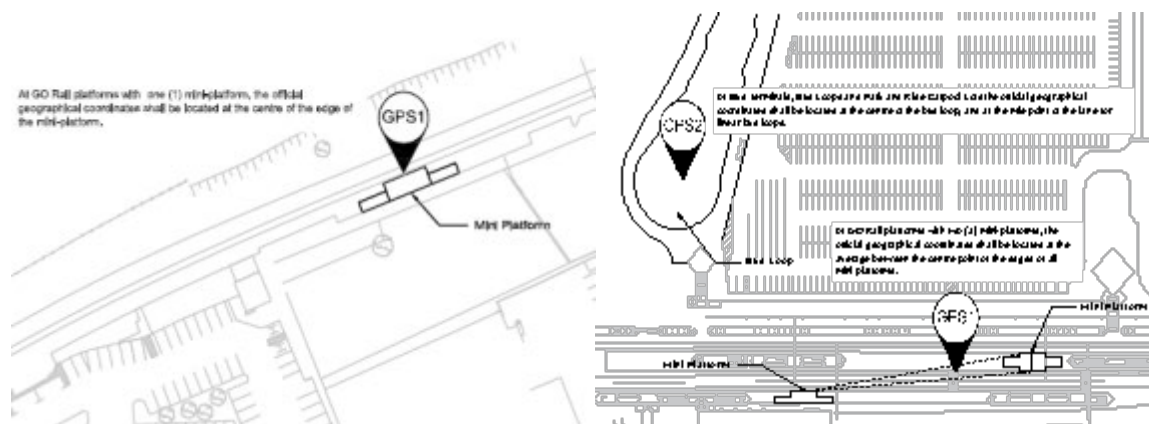

Figure 23: Geographical Coordinate Placement

5.12.2 Projection System

The following Reference Datums and Grid System shall be used, in accordance with the MTO's Engineering Survey Manual dated October 2006:

Map Projection→ 3-degree Modified Transverse Mercator (MTM) Zone 10

Horizontal Reference Datum→ North American Datum (NAD) 1983, using the NAD83 Canadian Spatial Reference System (CSRS) adjustment Horizontal Datum / Ellipsoid: NAD83 CSRS v.6 (epoch 2010.0) / GRS80

Vertical Reference Datum→ Canadian Geodetic Vertical Datum (CGVD) 1928 Orthometric Elevation:

5.12.3 Three-Dimensional Geodetic Control Points

- All GO Stations, Bus Terminals and Park and Ride Car Pool lots shall have three-dimensional geodetic control points installed with both Vertical and Horizontal known measurements
- Along the rail corridors, three-dimensional geodetic control points shall be installed and the monuments placed on fixed and stable structures including: bridges, abutments, retaining walls and grade separations
- Control points shall be placed on a fixed and stable structure, including, station buildings, parking structures, tunnels, bridges or abutments
- At locations with existing geodetic control points, benchmarks shall be removed and replaced during construction

Accuracy:

- Horizontal Control Points:
 - Network Accuracy of 4 cm (95% Confidence Interval) for Northing, Easting, and Ellipsoid Elevation relative to the Active Control Stations
 - Local Accuracy of 2 cm (95% Confidence Interval) for Northing, Easting, Ellipsoid Elevation relative to the adjoining station baselines at each location
- Vertical Control Points:
 - Elevation values of all installed monuments to be established by precise leveling. Methodology, equipment, and procedures shall comply with "Vertical Control Survey Specifications," MTO, May 2011.
 - Vertical accuracy shall be first order
 - Level loops to begin and end on an existing first order vertical benchmark
 - For each existing benchmark used, a stability check shall be done prior to commencement of leveling
 - All existing 1st Order geodetic benchmarks adjacent to a GO station must be measured

In cases where stable 1st Order benchmarks do not exist in areas adjacent to a GO station, other benchmarks may be used subject to authorization and instructions from the GO lead surveyor.

6 Building Program

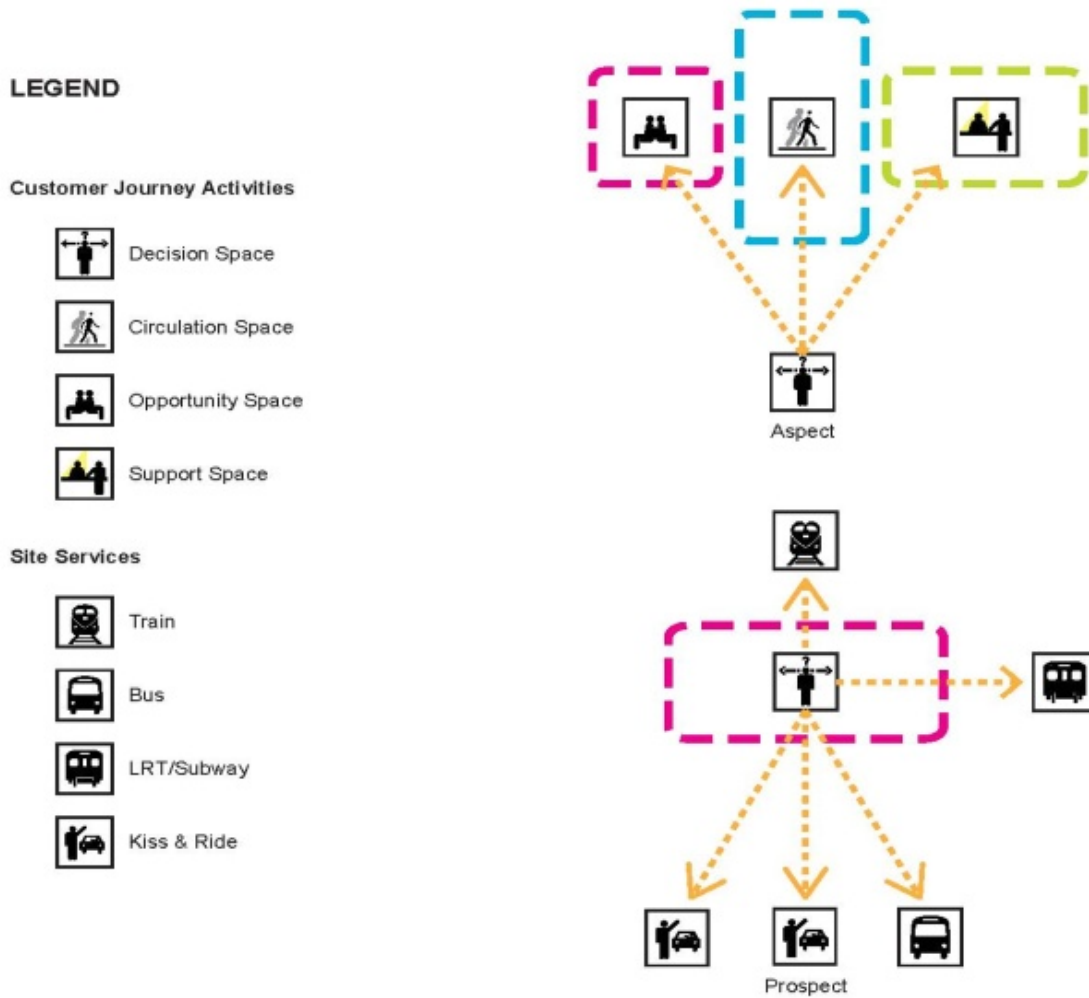

Figure 24: Station Building Program – Wayfinding and Customer Journey Points

6.1 Key Sustainability Accommodations

- Apply passive means of reducing energy where it does not conflict with other customer service and operational design requirements
- Maximize the use of natural light by using photosensor and /or daylight harvesting controls and dimming
- Utilize motion sensors and controls for lighting as required
- Reduce energy consumption and emissions at all buildings. Use heat recovery to conserve energy for heating and cooling
- Design sites using Crime Prevention Through Environmental Design (CPTED) principles to provide natural surveillance and safe travel through the site. This includes safe routes for

pedestrians and cyclists.

- Provide thermal comfort for staff and customers with protection from weather via canopies and shelters

6.2 Bus Terminals

Building Program for Terminals follows the Station Building requirements with the exception of the following areas provided in addition:

6.2.1 Dispatcher Room

The bus dispatcher room, where required, shall be elevated to permit the dispatcher in a seated position to have sight lines of all buses. It shall be located strategically for visibility of bus bays, particularly of arriving buses, where possible. The usual location is on an external wall, but it may also be located within the waiting room. Generally, it shall be adjacent to the driver room and shall have access from the driver room.

Both rooms may also be adjacent to the station attendant room, in which case a staff room may be provided in common for the dispatcher, drivers, and station attendants, with shared washroom and kitchenette facilities. Depending on the size of the facility, separate male and female staff/driver washrooms may be required.

The floor shall be elevated a minimum of 570 mm above the waiting room floor level and platform level, equivalent to a minimum 3-riser stair requirement. The seated dispatcher's eye level will then be approximately 1.69 m above platform level, over the heads of most passengers. Other design requirements include:

- Desk-height counter with insulated glazing above, knee-space below
- Side and/or back counters to be typical counter height with task lighting from wall-hung cabinets
- Wall hung cabinets with adjustable shelves and lockable doors
- Non-glare recessed LED luminaries with lense;
- If the room is on an exterior wall, insulating glass shall be fully tempered tinted low-E glass
- Interior locations to have fully tempered 10 mm clear glazing
- Where a dispatcher room is adjacent to a driver room, but has a separate entrance, a pass-through sliding-glass window shall be provided between them, operable by the dispatcher, for receiving driver reports and direct communications
- Where a dispatcher room is in a waiting room, the pass-through window may be required into the waiting room

6.3 Operational Facilities

6.3.1 Rail Operational Facilities

- Refer to standalone GO specifications for Rail Operational Facilities.

6.3.2 Bus Operational Facility

GO owns a number of Bus Operational Facilities for the purpose of storage, repair, maintenance, cleaning, and fueling, with ancillary administrative offices. Bus Operational Facilities are classified as

Type A, B, or C based on land sizing, parking, facilities provided and fleet requirements. Refer to the Table for Bus Operational Facility Typology and associated amenities.

Detailed design criteria will be provided by GO at the commencement of new projects. This Section is not intended to be a specification; the intent is to ensure uniformity in the Bus Operational Facility designs.

The standard Bus Operational Facility program is based on the following:

- Maintenance Facility
- Storage Facility
- Office Facility

6.3.3 Bus Operational Facility Typology

Table 8: Bus Operational Facility Typology

Bus Operational Facility Typology					
Land Requirements			Type A Full Service	Type B	Type C
			15+ acres	5-14 acres	3-4 acres
Parking	Buses	Indoor	40-105	21-42	12
		Outdoor	12	0-5	0-4
	Cars	Employee	140-200	33-56	14-20
		Corporate	10-12	2-6	1-2
Facility Requirements		Rooms	Yes	Yes	Yes
		Showers	Yes	Yes	Yes
		Lockers	Yes	Yes	Yes
		Lunchroom	Yes	Yes	Yes
		Kitchenette	Yes	Yes	Yes
		Lounge	Yes	Yes	-
		Office	Yes	Yes	Yes
Bus Fleet Maintenance	Fueling	Indoor	Yes	Yes	-
		Outdoor	-	Yes	Some

		Offsite	-	Some	Yes
	Repair Area	# Hoist Repair Bays	0-2	0-2	-
		Hoist	Yes	0	-
		Pit	2-3	0-1	-
		Bus Wash	2	1	-

6.3.4 Type “A” Bus Operational Facility

This program describes the general spatial provisions at a Type “A” bus operational facility.

Table 9: Exterior Circulation

Exterior Circulation	
<i>Feature</i>	<i>Design Requirements</i>
Roadway Tie-Ins	Interface with existing and future road and walkway networks One way traffic is preferred with minimum reverse operations.
Paving	Paving shall support vehicle types without cracking or settlement from standing or moving traffic. Concrete surfaces shall be provided for high bus traffic areas especially corners and outdoor fueling areas.
Curbs	Shall be designed and located per site conditions and industry standards.
Exterior Stairs/Ramps	Provide for barrier free and pedestrian access
Fencing	Fencing shall be a 2.44m high wrought iron fence along the front façade. The remaining perimeter will be 2.4m high black vinyl coated chain link fence.
Gates	Require high-speed by-fold automatic gates to be operated remotely from area(s) designated by the owner or through the FOB, two-way communication system if available. Gates must be activated by underground loop detectors, proximity cards, and existing bus transponders. Electrical controls shall be provided as part of the gate system and gate height is to match site fencing. All security gates shall have CCTV monitoring. Refer to Gates under Fencing in Section D & Table E-18 & E-19 for further

	information.
Stormwater Management	<p>Stormwater Management shall be designed by grading the site to direct run-off water to catch basins and subsequently to storm sewer system.</p> <p>In areas where drainage to grade would run to paved areas, direct to storm sewer.</p> <p>Ensure grades are provided to slope away from the building.</p> <p>No surface storage/ponding of water will be accepted in parking areas during storm events.</p>
Impact Protection	Provide impact protection to hydrants and any other structures or equipment installed within 2.0m of vehicle traffic areas. Refer to Section D.7, Site Furnishings, and Exterior Bollards for installation details.

Table 10: Landscaping

Landscaping	
Feature	Design Requirements
Design	<p>Landscape design shall ensure ease of maintenance. Materials shall be durable (e.g., salt resistant) and resistant to vandalism. Snow storage shall be taken into consideration.</p> <p>Landscape design shall respect the form, scale, and materials of both the surrounding area and proposed development. Circulation, comfort and safety, environment and crime protection (CPTED) shall also be considered in the choice of landscaping elements</p>
Native Plant Material	Native plant material as appropriate is encouraged. Patio areas with coloured concrete are preferable
Lawn Sprinkler Systems	Lawn Sprinkler systems, if required, shall be provided with timer (plus manual override)
Future Expansion	Landscape shall be able to accommodate future expansion with minimal disruption or disturbance.

Table 11: Signage

Signage	
Feature	Design Requirements
Signage	Refer to Metrolinx Sign Implementation Manual GO Transit Edition

Table 12: Clearance and Circulation

Clearance and Circulation	
Feature	Design Requirements
Heights	Coordinate clear building heights with actual heights of buses, equipment, and the like. Maintain minimums provided and as required for full and complete operation of the facility.
Features	Design the facility to accommodate ample clearance requirements in plan and elevation of all current GO buses and equipment and GO standard vehicle turning radius' and sweep paths with allowable safety factors.

Table 13: Structural Elements

Structural Elements	
Feature	Design Requirements
Structural System	The design shall be based on the most cost effective structural system when considered in the context of both the capital cost of construction and the projected life-cycle cost of the maintenance facility garage assuming a 50-year service life.
Building	The building shall be reinforced concrete, pre-stressed concrete, structural steel, or a combination of these.
Loading and Deformation Requirements	<p>The design shall consider the loading and deformation requirements of the structure in relation to the requirements of other disciplines.</p> <p>These disciplines shall identify the loading and deflection requirements and the anticipated structural deformations and movements of their work for incorporation in the structural design and construction.</p>

Table 14: Architectural Elements

Architectural Elements	
Feature	Design Requirements
Architectural Pre-Cast Panels	<p>Panels must comply with OBC requirements and have R-values as required by current industry standards.</p> <p>Rainscreens, if proposed, are to be installed with proper joint treatment using low VOC sealant. Interior of the precast panels shall be finished smooth suitable for paint application.</p> <p>Architectural elements carrying branding features need prior approval from GO</p>

Insulated Metal Siding	Shall be designed to withstand windload from inside and outside as required by current industry standards
Explosion Relief Panels	Design pressure relief panel system and shop calibrate to release at a static pressure differential between interior and exterior. Design panels and structural supports to withstand wind loads as required by current industry standards
Pre-Finished Aluminum Panels	Oil canning and deflection are unacceptable. Standard materials, components, fasteners and cap flashing per industry standards are preferred
Canopy	Soffit and flashing shall be prefinished aluminum panels.
Roofing	Easily maintained, roofing system technologies to meet specific LEED criteria.
Aluminum Curtain Walls And Windows	Fenestration shall comply with CAN/CSA standards regarding air and water leakage for aluminum windows. Exterior doors shall meet air-leakage rate requirements. The system shall be designed to accommodate expansion and contraction with a service temperature range of -35° C to +35° C
Roof Items	Above ground, roof serviceable items shall be designed to avoid fall hazards.
Skylights	Tinted, sealed, double-glazed units in clear anodized aluminum framing with positive drainage, and complete with integral curbs, is recommended. Sealed glass requirements shall be the same as specified for curtain walls but with heat strengthened exterior light and laminated heat strengthened interior light
Exterior Bollards	Refer to Section D.7, Site Furnishings, Exterior Bollards.
Sound Transmission Class (STC)	Private offices, meeting rooms, training rooms, drivers' quiet areas, and all office washrooms shall be designed to achieve a minimum STC rating of 55. Stores and Simulator rooms shall have a STC rating of 63, unless otherwise specified
Masonry Partitions	Block size; fire rating, etc. shall be standard concrete block, reinforced to Code Requirements.
Exterior Industrial Doors Overhead Doors	Exterior Industrial Doors/Overhead Doors are Foam-in-place, insulated, sectional overhead, torsion spring counterbalanced and electrically operated.

	<p>Controls and equipment and shall be of minimum lift 30' per sec speed with multiple safety systems to prevent damage or injury.</p> <p>Doors shall have a min. R-value of 12.5.</p> <p>Edge protection for operators (Machine Safeguarding) shall be provided.</p> <p>Door height shall accommodate overhead clearances per bus type at designated facilities</p>
Interior Hollow Metal Doors	To have the maximum glass lights as allowed by Code. All exterior hollow metal doors shall have clear insulating vision lights (150 x 600 typical).
Oversized Doors	At electrical rooms, storage rooms, mechanical rooms, compressor rooms, etc. shall allow for equipment delivery and removal
Wood Doors	Hardwood veneer in species in all administration areas with side and door lights
Overhead Coiling Fire Doors	Shall be face-of-wall mounted galvanized steel, manually operated complete with locking mechanism, fabricated in accordance with NFPA 80 standards
Counter Shutter	Coiling steel in the administration area shall have similar requirements as above and electrical powered.
High-Speed Fabric Doors	<p>High-speed fabric doors shall be fabric curtain with breakaway and electric reversing bottom bar, view windows, frames, counterbalance mechanism, controls, operators, and dual electric safety eyes.</p> <p>Curtain shall be selected to suit door opening width.</p>
Office Doors	Office doors shall have frosted glass for glazing and adjoining windows to have roller shades.
Traffic Lights	Shall be provided for all non-pedestrian doors: Green and red signals to indicate safe or unsafe conditions for vehicle "IN" movement. Lights shall be traffic style, complete with signs.
Motion Sensors	Shall be provided to increase monitoring distance to stop and reverse doors when in downward motion.
Sliding Automatic Entrance Doors (Exterior and Interior)	<p>Sliding automatic entrance doors shall include operator, header and track, jambs, sliding door panels, and sidelights.</p> <p>Units can be mounted within rough opening with sliding panels sliding along sidelight.</p> <p>Units will be bi-part and slide-swing panels shall slide along interior side with Microprocessor Master Control.</p>
Internal Handrails and Guardrails	<p>Internal handrails and guardrails shall be stainless steel.</p> <p>All external and wet location handrails and guardrails shall be Hot Dip</p>

	Galvanized.
Interior Bollards	Shall be 150mm diameter steel pipe concrete filled, galvanized and protected with a yellow 1/8" thick high density polyethylene 'safety yellow' coloured cover, projecting 1.2 m. above floor and cast with welded plate and 4 anchors into concrete slab, they shall be equipped with pole sleeve covers
Lockable Gates	Shall be minimum (600 mm x 1200 mm wide) with heavy-duty hinges and cylinder locks. Barrier free gates where located, shall be sliding and motorized with security features. Refer to Gates under Fencing in Section D & Table E-18 & E-19 for further information.
Wash Splash Guards	Wash splash guards shall be provided on each side of service lanes between bus wash equipment and building wall. Splash guards shall be corrosion-proof, minimum height 1.2 m above top of wash equipment
Hallway Windows	Shall allow natural light infiltration, UV protection film is recommended for sunlight diffusion.
Bike Lockers	Bike lockers shall be provided with power outlets for electrical bikes as determined by GO staff.
Concrete Curbs	Underneath the electrical panels shall be provided to protect conduits from the maintenance equipment (floor sweepers, etc.).

Table 15: Architectural Finishes

Architectural Finishes	
Feature	Design Requirements
Ceramic Tiles	Ceramic tiles shall be installed on high traffic area walls (4' high tile cladding for corridors) and wall dado installation for washrooms.
Porcelain/Resilient Tile Flooring	Tile flooring shall be provided in maintenance offices, hallways, vestibules, and high occupancy areas.
Carpet Tile	Shall be provided in offices, meeting rooms, etc.
Rubber Sports Floor	Rubber sports flooring shall be provided in the Wellness Room.
Stair Treads and Landings	Stair treads and landings shall be rubber treads with non-slip nosings to meet current industry accessibility standards.

Service Lanes and Degrease Bay Floors	3-part troweled system consisting of a two-part epoxy sand aggregate and topcoat in manufacturer's standard colour range.
Shop and Garage Area Floors	Minimum 4.88 kg/m2 trap rock, water cure, and liquid densifying sealer. Floor sealant shall provide necessary traction to avoid bus skidding at storage/service area/garage area.
Interior Painted Lines	Interior painted lines shall be provided along Safety Area around electrical panels and fire hoses and at hoist bays, pits and all shops. Epoxy based line painting shall be provided in all bus storage and maintenance areas.
Stock Room Counter	Shall be stainless steel with wood backing
Touch Zone	Up to 3m of the maintenance and storage facilities shall be epoxy coated to allow for pressure washing.

Table 16: Fixtures

Fixtures	
<i>Feature</i>	<i>Design Requirements</i>
Toilet Partitions and Urinal Screens	Toilet partitions and urinal screens shall be stainless steel, ceiling, or wall mounted.
Aqueous Ozone Cleaning System (AOCS)	High stability (24 hour) Aqueous Ozone Cleaning System (AOCS) to meet Green Seal standards GS-37 and GS-53.
Sloped Top Lockers	Top lockers shall be pre-finished, sloped top, located on concrete base.
Coat and Hat Racks	Coat and hat racks shall be provided in administration areas.
Foot Grilles	Foot grilles shall be vinyl surfaced, recessed type, in extruded 6063-T52 aluminum alloy framing.
Roller Shades	Rollers shades shall be provided for all windows in the Administration Building.
Meeting Room Fixtures	Meeting rooms shall be equipped with ceiling mounted motorized projection screen, projectors, and speakers.
Kitchen Equipment/Fixtures	Kitchens shall be commercial quality, energy star compliant. Kitchens shall include refrigerators, ovens with a range ventilation hood to the outside, built-in or counter top microwaves, and dishwashers.
Dual Burner Coffee Makers	Coffee makers shall have an in-line water filter and be provided in the

	Training Centre and Administration Lunch Room
TVs	TV's shall be provided to suit the Lunch Room size.
Countertops	Countertops in all kitchens, washrooms, and dispatch areas shall be solid surfacing 12 or 13 mm thick with a backsplash-6 mm thick.
Pop and Snack Dispenser	One (1) pop and snack dispenser each shall be located in the lunch area.

Table 17: Specialties

Specialties (the facility design shall incorporate these specialty features)	
Feature	Design Requirements
Hybrid Bus Wash System	Hybrid bus wash systems shall be environmentally friendly, with front and rear high-pressure wash and side brush systems.
Fueling Monitoring	Indoor or outdoor bus fueling service bays per facility type with full TSSA compliance for operation and maintenance
Inspection Pit Bays	Shall comprise of inspection pits, pit jacks, central pit catch basins, fluids distribution, waste fluid drains and compressed air distribution and explosion proof low voltage lighting / ventilation (bottom pit air vents).
Fluid Dispensing and Tank Storage	Fluid dispensing and tank storage shall be designed for spill containment.
Compressed Air	Compressed air distribution
Tracking Systems	Radio/Antennae/Vehicle tracking systems/Satellite TV provision
High Speed Doors	With machine safeguarding
Traffic Signals	Traffic Signals/detector loops
Environmental Controls	Separators/sand pits and Sand and oil interceptors.
Control	Geodetic control survey movements
Arrest System	Roof Fall Arrest System Travel Arrest as Required
Elevators	Electric Traction MRL Elevator(s)
Snow Melting	Snow melting at desired locations.

Floor Heating	Radiant floor heating.
Equipment	Equipment shall include Loading Dock, Door, Seal, Trailer Restraint, and Leveler Equipment.
Architectural Specialties	Include toilet partitions and screens, washroom accessories, lockers, coat and hat racks, foot grilles, coat hooks and shelf unit, ceiling mounted projection screen, pass-thru window.

Table 18: Life Safety

Life Safety	
Feature	Design Requirements
Fire Safety Plan	<p>Fire Safety Plan to be developed specifically to the category / facility type it is design for, and consistent with local Fire Department requirements. The facility design shall incorporate the following features:</p> <ul style="list-style-type: none"> • Alarm systems–interface/monitoring including vehicle emission alarms with CO2 and NO sensors. • Automated energy and environmental monitoring/management systems • First Aid/Emergency routing • Monitoring systems • Sprinklers • AED

Table 19: Safety and Security

Safety and Security	
Feature	Design Requirements
Design Optimal Safe Solutions	<p>Design Consultant to demonstrate their design's optimal safe solutions based on comprehensive Risk Assessment and sound Safety Engineering Principles.</p> <p>Some elements may include Cost Benefit Analysis, Alternatives Comparison, Threat Vulnerability Assessment, Safety Factors, and Residual Risks. Office of System Safety shall be consulted for solution assessment.</p>
Site Assessment	<p>Each site shall be assessed to determine the extent to which perimeter security and controlled access points are provided. In general, perimeter fencing and controlled gated vehicular access shall be required to protect the Bus Maintenance Facility from unauthorized entry, vandalism, theft,</p>

	and terrorism.
Points of Entry	All points of entry must be furnished with street lighting, controlled access systems monitored with closed circuit video system camera which is to be fed to a central location named by GO.
Fencing	<ul style="list-style-type: none"> • Fencing shall be designed as one of the physical delineation measures around the facility to control and monitor authorized access into the area. • Designs shall consider first passive security measures i.e., CPTED (Crime Prevention Through Environmental Design) before active ones.
Design Features	<p>The design shall incorporate the following features:</p> <ul style="list-style-type: none"> • High speed gates • Surveillance • Access control–Proximity cards • Local intercom controlling gates onto property • Design facilities to follow basic Safety Engineering principles: • Eliminate hazards by engineering design • Follow FTA / APTA recommendations, guidelines for Bus Facilities • Exceed relevant safety legislations (i.e., OHSA, TSSA, CSA, OESC, CEC etc.) as required to minimize risk(s) • Consider potential future expansion, modifications, retrofits • The design of the facility shall be safe and easily serviceable, maintainable and user friendly.
Design Concerns	<ul style="list-style-type: none"> • Some of the typical, but not limited concerns include: • Fall Hazards (adequate roof perimeter protection–parapet, guardrails if necessary, adequately load rated skylights, location and position of serviceable equipment above ground level / at height, roof access, adequate clearance from the roof edge (min. 3.0 m), etc. • Aligning of lighting fixtures, gas lines, power lines (and other serviceable components) with flat landing section and avoid interference with structural components for easy access. • Avoid Confined Spaces (adequate ventilation, atmospheric condition, access, egress, rescue, etc.). • Avoid pinch points / spots / corners (adequate walkways, clearances, visibility, access, egress, reach, etc.). • Any sources of energy to be lockable–(CSA Z 460) • All qualified equipment / machine to be properly safeguarded–

	<p>(CSA Z 432)</p> <ul style="list-style-type: none"> • Electrical, for information on Arc Flash Hazards and labeling” after reference to Arc Flash • PSR's (Pre-Start H&S Reviews–Industrial Establishments, O. Reg. 851 / 06 section 7) to be conducted as required. • Ergonomics, cognitive concepts to be utilized (signage, information effectiveness etc.) • Human Factors, Ergonomics, cognitive concepts to be utilized (signage, information presentation, effectiveness etc.); MIL STD 1472 is suggested as a minimum, may be supplemented by other respected references. • Traffic flow to separate / reduce crossovers (cars, buses, pedestrians)
<p>Securing and Monitoring of Facilities</p>	<ul style="list-style-type: none"> • Design Facilities to be adequately secured and monitored • Some of the typical, but not limited, concerns include: • Follow proper Safety & Security Planning (i.e., TVA, study crime rate within the specified area etc.) • Entire facility's perimeter to be adequately delineated / fenced (physical security, CPTED principles to be utilized). • Gates / Access control plan. • Fire Separation Zones (vulnerable areas) • CCTV cameras / system • Other Security measures ('cash in / out' activities, secure transactions) where applicable.
<p>Environmental Concerns</p>	<ul style="list-style-type: none"> • Design Facilities to be environmentally friendly • Some of the typical, but not limited concerns: • Isolate and protect vulnerable areas, enhance detection systems, hardened protective materials i.e., storage tanks. • Spill containment to be within the room, few levels of redundancies anticipated. • Septic tank, if required, to be isolated from oil collecting system (potential overflow concern). • Bulk fluids tank to be strategically placed and protected (accidental damages).
<p>Bus Traffic Flow</p>	<ul style="list-style-type: none"> • Bus Traffic flow: • To eliminate 180 degree bus turns. • To separate / reduce traffic crossovers (passenger cars, buses,

	<p>pedestrians)</p> <ul style="list-style-type: none"> • Skylights shall be designed with consideration for material, location, position, fall protection, etc.). • Guardrails on the roof shall be provided if required as a fall arrest system.
--	---

Table 20: Communications

Communications	
Feature	Design Requirements
Key Components	<ul style="list-style-type: none"> • The key components of communications in bus maintenance facilities are as follows: • CCTV • Security and Telephone (interconnected with GO regional offices) • Network synchronized clock and coax cable distribution. • PRESTO
System Interface	<ul style="list-style-type: none"> • The following systems shall interface with existing GO related services: • Radios Trunking system • Telephones • IT/LAN • Public address system • Intercom system • Cable TV distribution system • Security system • Building Automation System (BAS) • Refer to Metrolinx Standard Building Automation Systems Performance Specification 25 05 10 for details. • Tank and Fuel Card Lock System • CCTV system • Signal lights

Table 21: Mechanical

Mechanical	
Feature	Design Requirements
Guidelines	<p>Requirements for the design, specification, and installation of mechanical equipment are to be used in conjunction with this Manual.</p> <p>The Consultant shall ensure that all applicable codes and standards are included in the construction documents.</p> <p>Fire suppression systems shall be provided in all applicable areas.</p> <p>Domestic hot water will be supplied by natural-gas fire instantaneous hot water heaters.</p> <p>Floor drains shall be used in the office and general area and trench drains or precast concrete catch basins and degrease bays are to be provided in repair garages, bus bays and storage areas.</p> <p>Control Flow of roof drainage with heat tracing shall be provided.</p> <p>Standpipe system for type "A" facilities shall be provided.</p> <p>Use CSA approved plumbing fixtures in all washrooms, showers, lunchrooms and kitchenettes and wherever else applicable.</p> <p>Provide gravity drainage systems wherever possible.</p> <p>Comply with code requirements for indoor air quality.</p> <p>Ensure proper maintenance of repair garages, inspection pits, service lanes, and storage garages.</p> <p>High-level ducted exhaust shall be provided.</p> <p>Unit heaters or radiant heating system shall be provided at every external door location.</p> <p>Central hot water generating and distribution system shall be provided.</p> <p>Bus engine exhaust and bus auxiliary heater exhaust system, battery charging areas, lube room and hazardous materials storage, shall be provided.</p> <p>Insulate ductwork and piping shall be provided as specified.</p> <p>Piping materials, which are compatible with environmental conditions, shall be used.</p> <p>Valves, thermometers, pressure gauges shall be installed as detailed.</p> <p>Complete building automation system shall be provided. Refer to Metrolinx Standard Building Automation Systems Performance Specification 25 05 10 for details.</p> <p>Where applicable, provide fuel storage and dispensing system, which shall be designed and certified by a licensed engineer.</p>

	<p>Provide gas fired, heated, multi-station pressure washer systems.</p> <p>Provide vehicle wash systems as specified by GO standards.</p> <p>Provide in-ground bus hoists, mobile lifting columns, inspection pit axle hoists, service fluids, central vacuum systems, compressed air systems, and gas detection systems as specified by GO standards.</p> <p>Mechanical systems and services must be designed to permit future expansions with minimum disruption in operations</p>
Mechanical Requirements	<p>The following shall also be provided as part of the mechanical requirements of the facility:</p> <ul style="list-style-type: none"> • Commissioning • Energy efficiency • Construction IAQ managing • Electric heat tracing and snow melting
Process Equipment and Systems	<p>Process equipment and systems to include:</p> <ul style="list-style-type: none"> • Fuel storage and dispensing • Pressure-washer systems • Vehicle wash systems • Bus hoists • Fueling card lock system • Tank monitoring system • Service fluids dispensing system • Central vacuum systems • Compressed air system • Hose reels • Gas Detection Systems

Table 22: Electrical

Electrical	
<i>Feature</i>	<i>Design Requirements</i>
Electrical	Refer to Section 7

Table 23: Future Expansion

Future Expansion	
Feature	Design Requirements
Mechanical and Electrical Systems and Services	Mechanical and electrical systems and services must be designed to permit future expansion with minimum disruption to operations.
Radiant Floor Heating Systems	Radiant floor heating systems must be expandable without cutting the slab previously installed.
Fire Suppression Systems	Must be designed so that zones installed may be expanded without modification of existing piping, or spare piping must be run from the header or pre-action control unit, for connection extension in the future. Headers and/or pre-action control equipment must be sized to accommodate the future expansion
Compressed Air Piping	Must include valves and capped connection to permit extension of the system installed in this phase without disruption to operations.
Sanitary Drainage Systems and Storm Drainage Systems	Sanitary and storm drainage systems must be installed with invert elevations and configuration to permit expansion without removal of more than 2 m ² of slab on grade at each connection within 1.2 m of building exterior wall.
Control Systems	Control systems shall include provision for future expansion without replacement or duplication of operator's workstation.

Table 24: CCTV

CCTV	
Feature	Design Requirements
Location	Exterior to the main facility may have storage for buses and other maintenance equipment
Bus Movement	Bus movement is restricted to authorized and appropriately licensed personnel with directional control in and around the facility.

Table 25: Automated or Monitored Gates

Automated or Monitored Gates	
Feature	Design Requirements
Features	<ul style="list-style-type: none"> Dedicated cameras

	<ul style="list-style-type: none"> • Individual cameras for each gate • Identify individual and vehicle movement • Read license plate and or any vehicle identifiers • PTZ type set to maximize control point area • May be mounted on building or dedicated 6m pole, depending on location • Refer to Gates under Fencing in Section D & Table E-18 & E-19 for further information
--	---

Table 26: Main Gate

Man Gates	
Feature	Design Requirements
Features	<ul style="list-style-type: none"> • Individual cameras for each man gate • Identify individual and movement • PTZ type set to maximize control point area • May be mounted on building or dedicated 6m pole, depending on location • Refer to Gates under Fencing in Section D & Table E-18 & E-19 for further information

Table 27: Main Gate

General Office	
Space	Design Requirements
Main Entrance Vestibule and Lobby	Main entrance vestibule and lobby shall have reception counter and separate workstation.
Unisex Visitors Washroom	Unisex visitors' washroom shall be barrier free.
Managers' Offices	Fleet Transit Safety and Facilities Managers, rooms shall be sized as per GO Standard Office Module Furniture.
Radio System Specialist Office	GO Standard Workstation Modules.
Senior Fleet Supervisor Office	GO Standard Workstation Modules.
Bus Facilities Supervisor Office	GO Standard Workstation Modules.
Administrative Staff	GO Standard Workstation Modules.

Workstations	
Customer Care Coordinator	GO Standard Workstation Modules.
Performance Advisor	GO Standard Workstation Modules.
Spare 'hoteling' Workstation	Spare hoteling workstation shall be common to all functions.
Storage Room	Storage room shall secure File Storage, Printer, Fax, and Vault.
Meeting Rooms	Capacity: (8/12/20 persons), as advised by GO.
Lunchroom / Kitchen	Lunchroom / kitchen shall accommodate 12 people at any given time.
Printer / Fax / Photocopier Room	Printer / fax / photocopier shall be centrally located room with supply storage, work surfaces, and office mail slot.
Men's Washroom	Men's washroom shall be barrier Free, WC's and urinals as per program requirement.
Women's Washroom	Women's washroom shall be barrier Free, 3 WC's.
File Area	File area shall be a central file and office supply and MTO Records Storage.

Table 28: Safety and Training Programs

Safety and Training Programs (as Advised by GO)	
Space	Design Requirements
Transit Safety Group Supervisors (Min. 2)	GO Standard Workstation Modules.
Transit Safety Staff Coordinators Workstations	GO Standard Workstation Modules.
Video Viewing Room	Video viewing room Shall contain Video Storage Shelves.
Transit Safety File Storage Room	Secure file Storage Printer and Fax.
Driver's Safety & Training Centre	To be used by Transit Safety for presentations to 30 people.
Simulator room	To be used by Transit Safety for presentations to 30 people.
Training Centre Supply Room	The Training Centre Supply Room shall be provided with shelving.

Kitchenette–Training Centre	-
Safety & Training Supervisor	File storage area required.

Table 29: Administration and Services - Operations

Administration and Services: Operations	
Space	Design Requirements
Manager of Operations and Bus Facilities	Room sized per GO Standard Office Module Furniture.
Superintendent of Operations	GO Standard Workstation Module.
Bus Operations Supervisor	GO Standard Workstation Module. File storage area required.
Bus Driver's Quiet Room	Bus drivers quiet room to accommodate recliners per program requirement.
Bus Driver's Reporting Room	Bus drivers reporting room shall have no more than 20% attendance at any time.
Dispatch Area	Adjacent to Reporting Area, with pass thru window, Radio system, Bus AVL, Train AVL, White Board, TV. Monitors faced away from general viewing. These include workstations per program requirement.
Main Communications Equipment	-
Cash In Room	Cash in room shall be located with a view to Dispatch and shall be provided with built-in workstation and pass-through window.
Driver's Mail & Forms Room	Driver's mail and forms room shall be equipped with shelving for storage and mail slots.
Men's Washroom & Showers	WCs, urinals, showers, lockers for the Wellness Centre and full lockers for Transit Safety and Station Services per program requirement.
Women's Washroom & Showers	Close to Wellness Centre, with ½ size lockers as required, placed on a 100mm concrete curb.
Bus Drivers Lockers	-
Meeting Room	-

Records Storage Room	-
Wellness Centre (With External View)	Separate Wellness Centre lockers are required. Lockers shall accommodate half size lockers per facility type requirements.
Bus Drivers' Lunchroom	Bus drivers' lunchrooms shall be sized to suit program requirement, outdoor patio with natural gas connection, and be provided with a BBQ with provision for outdoor furniture.
Bus Drivers' Kitchen	The bus drivers' kitchen shall be adjacent to Lunchroom.
Bike Storage Room	The Bike Storage Room capacity shall meet LEED requirements with electrical receptacles.
Uniforms Room	Operations and Maintenance.
First Aid Room	-

Table 30: Maintenance Facilities - Service Lanes

Maintenance Facilities: Service Lanes	
Space	Design Requirements
Service Lanes	<p>Service lanes are drive through bays, bus wash lanes, and bypass lanes as per program requirements.</p> <p>They shall include:</p> <ul style="list-style-type: none"> • Rapid doors when required • Additional 3m at the end of a bus <p>The layout shall incorporate smooth functional-flow forward movement with minimized reverse movements, one-way traffic, and the ability to circulate buses within the property while designed to eliminate potential for sharp and abrupt turning (more than 90?).</p>
Unisex Washroom	Unisex washrooms shall be barrier free.
Wash Equipment Room	<ul style="list-style-type: none"> • Within Service Lanes • Pressure Wash in separate room

Table 31: Maintenance Facilities - Plant Maintenance

Maintenance Facilities: Plant Maintenance	
Space	Design Requirements
Internal Driveway	In-floor heating system shall be embedded in the concrete apron and snowmelt system for all exterior door areas. Heat tracing systems shall be installed, if required.
Special Clean (Double Bay)	There shall be a minimum of one bus per bay. Industrial vacuum with six outlets and commercial grade hoses, hangers and tools, pressure washer, hose bibs, sink and trench drains. Hot & cool water source required. Vehicle exhausts system and wet area to be provided. Bus wash equipment shall be placed on elevated concrete pads. Harvested rainwater could also be used for bus wash.
Mechanical Room	Between Special Clean and Degrease. Houses pressure washer, vacuum cleaner, air compressor and related equipment and supplies. Provide foot operated wash basin(s).
Shop Electrical Room	Between Special Clean and Degrease.
Degrease Bay	In-ground hoist with sediment pits, trench drains and pressure washer with reels and hoses (wet area). Complete fluid distribution system. Vehicle exhausts system. Floor mounted equipment shall be placed on elevated concrete pads.
Body Repair Bay	The body repair bay shall contain a portable hoist to assist in transporting bus windows, windshields during removal and installation, and a vehicle exhausts system.
Fabrication Rebuild Shop	The Fabrication Rebuild Shop shall include a drill press, band saw, welding materials supplies, sink / parts washer, portable hoists, exhaust hoods and additional ventilation. Design foundation (concrete base) with adequate capacity to accept mobile hoists.
Inspection Pit Bays	The inspection pit bays shall include waste oil removal and pit jacks. Complete fluid distribution system. Vehicle exhausts system.

In Ground Hoists	Complete fluid distribution system with side drains and central drains. Vehicle exhausts system.
Above Ground Hoists	Portable bus hoists. Vehicle exhausts system and fluid distribution.
Waste Fluids Disposal Area	-
Pump Room	Oil/grease interceptors. Dedicated catchbasin as floor drains shall be provided.
Fleet Equipment Storage	Fleet equipment storage shall include mobile repair equipment.
Parts Degrease Room	Wash/spray equipment (area).
Bus Wash Area	Hybrid water recycling & wash, all structural steel to be galvanised, walls, no copper or schedule 40 pipe PVC or stainless only
Fuel Area	Anti-Slip floor, one dispenser per lane, monitoring system
Shop Equipment Storage	-
Small Comp. Rebuild / Storage	Shelving
Transit Enforcement Storage Room	Caged parts storage area
Radio Storage Room	Shelving
Radio Repair	Shelving with HVAC

Table 32: Maintenance Facilities - Training Area

Maintenance Facilities: Supervisory Training Area	
Space	Design Requirements
Fleet Maintenance Supervisors	The workstations shall be located in one room at the centre of the shop with a good view of shop.
File Storage, Fax/Photocopy	File storage, fax, and photocopiers shall be in the Maintenance Supervisor space.
Kitchenette	The kitchenette shall be attached to the Maintenance Supervisor's office.
Meeting Room	Seating capacity per program requirement, kitchenette, smart board,

	projector and power screen.
Mechanic's Training Room	The mechanic's training room shall be located on the exterior wall, soundproofed with a small kitchenette.
Classroom with Kitchenette	Seating capacity per program requirement, kitchenette, smart board, projector and power screen.
Classroom Storage	Accessible from classroom, storage for wheel chair, scooter.
Training Supervisor's Office	The training supervisor's office shall be located on the exterior wall and soundproofed.
Men's & Women's Washroom	The men and women's washroom shall be adjacent Fleet Maintenance Supervisors.

Table 33: Maintenance Facilities - Shop Employee Service Rooms

Maintenance Facilities: Shop Employee Service Rooms	
Space	Design Requirements
Men's Washroom & Showers	The men's washroom and showers shall be barrier Free with urinals, WCs, and showers.
Women's Washroom & Showers	The women's washroom and showers shall be barrier Free with WCs and showers.
Men's Lockers	Men shall have two lockers per person & Half-Bradley's adjacent to the washroom.
Women's Lockers	Women shall have two lockers per person.
Lunchroom	Seating capacity as advised, outdoor patio.
Laundry Room	-
First Aid Room	-
Eyewash Station and Drinking Fountains	The eyewash station shall be tucked or 'nicked' in, located on the shop floor, and provided with bottle fill spouts and filers.

Table 34: Storage Facilities - Bus Storage Garage

Storage Facilities: Bus Storage Garage	
Space	Design Requirements
Garage	<p>Capacity based on a Type "A" facility.</p> <p>Based on a (±) 14.5m long (±) 2.75m wide bus.</p> <p>Double Decker buses need a minimum height clearance of 5.2m in the storage garage and minimum 7m height clearance at the repair shops (includes the portable hoists clearances).</p> <p>Provide for future expansion (as advised by GO).</p>

Table 35: Storage Facilities - Stores

Storage Facilities: Stores	
Space	Design Requirements
Part's Counter	<ul style="list-style-type: none"> • Workstations with PC`s, rugged stainless counter • Under counter storage for computers and office supplies
Large Parts Storage	Adjacent to Shipping / Receiving Dock, Shelving requirements
Small Parts Storage	Racking requirement
Tool Storage Room	Shelving requirement
Bulk Drum Storage & Dispensing	Area included in Parts Storage
Empty Drum Storage	Area included in Parts Storage
Store's Office	Office staff in on enclosed space with HVAC
Station Services Area	Includes one (1) office and storage room with shelving and HVAC
Tire Storage & Repair Area	Used/rebuild tires, maximum of 125 with appropriate storage and racking
Battery Storage & Charging	Shelving and chargers, special ventilation and forklift access
Bulk Fluid Storage (Oils/Lube/etc.)	Special Ventilation adjacent flammables room
Flammable Dispensing Room	<ul style="list-style-type: none"> • Blast wall, grounding, containment, special ventilation and fire safeguards

	<ul style="list-style-type: none"> • Threshold (concrete) to contain spills and dedicated catchbasin as floor drain
Mezzanine	Over Small Shop Areas with clear fork lift access.
Receiving Loading Dock	There shall be two loading docks (one at grade, one below grade with dock leveler) and one workstation shielded when doors are open.
Men's & Women's Washroom	The men and women's washroom shall be located close to the Parts Counter.

Table 36: Other – Interior Spaces

Other–Interior Spaces	
Space	Design Requirements
Sprinkler Room	<ul style="list-style-type: none"> • Refer to Metrolinx Standard Fire Protection Sprinkler System Specification 21 13 00 • Connect Sprinkler System to Fire Alarm and BAS systems
Mechanical Room	Adjacent to Shipping / Receiving Dock, shelving requirements
Electrical Room	Refer to Section F, Service Room Requirements
Communications Closets	Placed as needed, easily accessible
Janitor's Room	<p>In Administration Office Area</p> <ul style="list-style-type: none"> • Floor mounted slop sink with easy access clean out for slop sink P- trap • Faucets and floor drains • High stability (24 hour) Aqueous Ozone Cleaning System (AOCS) • Domestic cold water complete with shut-off valve, dedicated for AOCS, water pressure shall be minimum 30 PSI (207 kPa) and maximum 65 PSI (488 kPa).
Garbage Recycling Room	-
Other	<p>Catwalk by the clerestory windows provides access to bay fluid lines on/off valves.</p> <p>Sound Isolation shall be provided for all noise generating equipment.</p> <p>High Pressure hot water equipment shall not be located in wet areas.</p>
PRESTO Room	Placed as needed, easily accessible

Electrical Closet	Placed as needed
Generator	Refer to Section F – Technical Requirements, Backup Power Systems

Table 37: Other – Exterior Spaces

Other–Exterior Spaces	
Space	Design Requirements
Transformer	Exterior Location
Generator	Refer to Section F – Technical Requirements, Backup Power Systems
Patio	Exterior Ground Level Location
Gatehouse	Exterior Location
Brake Test Area	Exterior Location (included in circulation driveways)
Compressed Gas Storage Area	1 for propane, 1 for oxygen–gated, fenced with roof.
Compressor Room	Scroll Compressor with dryer
Garbage/Recycling Storage Area	Exterior Location, visually hidden
Bulk Fuel Storage	<ul style="list-style-type: none"> • Exterior, In ground Location for 2 X 50,000 litres • Card lock system with remote access shall be provided. • SS Fittings • Double fuel pump hoses: • (1) ¾" nozzle for light trucks • (1) 1" nozzle for buses shall be provided
Service Fluids tanks	Service fluid tanks shall be guarded with additional containment near shop. Automatic Tank gauges monitoring system shall be provided with remote access.
Powered Gas Tools Storage Shed	-
Service Vehicles Parking	For Operations, Fleet and Transit Safety
Bus Storage Parking	<ul style="list-style-type: none"> • Exterior, 12 buses in a single area near fleet shop

	<ul style="list-style-type: none"> • 115V 15Amp circuits for block heaters and battery chargers
Staff Parking	<ul style="list-style-type: none"> • Exterior, parking spots with gated personnel entrance to the secure facilities compound +16 parking spots for GO Transit support • Motorcycle Pad • EV plug in locations as advised
Bus Storage Parking Expansion space	As advised
Co-generation / Tri-generation	If provided, minimum area needed = 15m X 8m

7 Technical Requirements

7.1 General Technical Requirements

- Apart from compliance with good Engineering practice, the design shall meet the requirement as per the relative regulations, codes and standards, and address energy use to reduce consumption.
- All equipment shall be provided from a recognized manufacturer with proven product testing. Any alterations or changes to equipment shall be approved for use prior to installation.
- For additional information, refer to GO Standard Specifications and Drawings.

7.2 Electrical

Electrical systems for GO Transit facilities shall comprise the following, including all relevant supply, protection, distribution, and control of alternating and direct current systems:

- Primary and secondary power services
- Illumination
- Grounding
- Equipment labeling and identification

7.2.1 Supply of Primary and Secondary Power Sources

7.2.1.1 Incoming Utility Services

The local Supply Authority (PUC) will supply utility services to a site or building. Services to an electrical room or kiosk shall be underground.

7.2.1.2 Service Requirements

- Line Stations: The service is to be sized to accommodate current and future known loads plus

50%, 400 amp min, 347/600 volt or 120/208 volt service. Maintenance, Repair, Shop and Garage facilities and facilities with elevators: 347/600 volt service

- Incoming services, utility metering, dedicated Metrolinx metering complete with remote monitoring, disconnected switches, distribution breakers shall be in one switchboard/distribution panel
- Where GO Transit has tenants, check meters shall be required. One for each tenant
- Service size shall be based on the application of conservative engineering design principles consistent with cost effective provisions for future station/terminal or other facility expansion
- Temporary facilities shall have underground services.
- Disconnect switches shall come equipped with visual means to ensure power disconnection (LED indicator or viewing window) Utilization Voltages. For additional information, see Disconnect Switches Specification 26 28 23.

Table 38: Utilization Voltages #1

System	Utilization	Voltage
Lighting	LED	347V or 120 V 1 phase interior, 347 V or 120 V 1 phase for all exterior application

7.2.1.3 Balancing of Phases

Where single-phase power is taken from a 3-phase source, the loads shall be balanced among the three distribution phases. Sites that have a single-phase source are to maintain the load on the distribution panels balanced.

7.2.1.4 Voltage Drop

The maximum allowable voltage drop is 2%.

7.2.1.5 Power Factor

The overall system power factor shall be greater than 90% or .9 PF. Power factor design calculations are to be done using an 80% or .8 PF.

Table 39: Utilization Voltages #2

System	Utilization	Voltage
Life Safety Egress Lighting	LED	347V or 120 V 1 phase interior, + Life safety emergency power
Heating	Greater than 5 kW	600/347 V

		3 phase
	5 kw or less	120/208 V 1 phase
Life Safety Fire Pumps		600/347V or 208/120 V 3 phase interior, + Life safety emergency power
Motors (fans and sump pumps shall be off of emergency power)	Greater than ½ HP	600/347V, 3 phase
	½ HP or less	120/208V, 1 phase
Elevators	Motors and Controls	120/208V, or 600/347V 3 phase + emergency power
P.A. (70V)		Feed to the PA is 120V 1 phase + emergency power
Telephone System		120V 1 phase + emergency power
CCTV		CCTV cameras are PoE + emergency power
Security/Alarm		120V 1 phase + emergency power
Passenger Information		120V 1 phase + emergency power
Fire Alarm		120V 1 phase + Life safety emergency power
Proof-of-Payment Fare Collection System		120V 1 phase + emergency power
Electronic Payment Systems		120V 1 phase + emergency power
Intercom		120V 1 phase + Life safety emergency power
Video Transmission		120V 1 phase + emergency power
Digital Clock System (network)		120V 1 phase + emergency power

Signage and Display System		120V 1 phase + emergency power
Wayside Power System:		600V 3 phase
Building Automation System		120V 1 phase + emergency power
Computers		120V 1 phase + emergency power
Fuel Management Systems		120/208V, or 600/347V 3 phase + emergency power
Sand Distribution Systems		120/208V, or 600/347V 3 phase + emergency power
Electric Vehicle Charging Systems		120V/208 1 phase + emergency power for operations purposes
Car counting Systems		120V1 phase + emergency power
Aqueous Ozone Cleaning System (AOCS)		120V1 phase 20A GFCI, dedicated circuit + emergency power

7.2.1.6 Backup Power Systems

This subject describes the functional requirements for Metrolinx facilities backup power system. The power generated by the backup system shall be either true sinusoidal 60 Hz or DC, depending on the requirements.

The intent is to ensure the continuing operation of essential equipment and services, and to effectively move passengers from station buildings and train platforms to outside parking areas in the event of a sustained power failure.

The final design of the backup power system must include an as-built schematic drawing of the system distribution. It shall also include a checklist for commissioning, operation, and maintenance, respectively.

Back-up power generators shall be installed in accordance with the Electrical Safety Authority (ESA), Technical Standards and Safety Authority (TSSA) and the regulations of the electrical inspection agency having jurisdiction. The back-up power generator shall be protected from surface deterioration caused by exposure to conditions (i.e: condensation, weather, winter maintenance and de-icing chemicals) producing corrosion. Flat surfaces which may retain water are not permitted.

Provide safe access (min 1m).

7.2.1.7 Backup Required Time

Back-up power generators are a mandatory requirement, for providing the majority of our operational elements/ systems for 48 hours system operational duration.

- GO Rail Line Stations (including Parking Structures)
- GO Bus Terminals (facilities with a station building only)
- GO Rail Layover Facilities

- GO Operational Support Facilities (i.e. Wolfdale, GTCC, Middlefield)
- GO Bus Maintenance Facilities
- GO Rail Maintenance Facilities

Backup Power System’s design can include components such as Generator, UPS, Inverter, Rectifier, etc. As a minimum, the backup Power System shall include diesel or natural gas generator complete with UPS systems having a minimum of 30-minute duration or UPS systems with 90-minute minimum duration if there is no diesel/natural gas generator set.

In each case, the UPS shall be double conversion continuous duty type to provide the electronic communications systems with clean sine wave power. The UPS/Inverter shall be rated for life safety applications and shall be provided with signals for indication of general alarms and with dial in remote monitoring control, plus a remote alarm to the station alarm system and Network/ BAS. There shall be one UPS for the site for operations critical equipment and one UPS/ Inverter dedicated to Life Safety equipment support as per the OESC. For further information on UPS inverters, rectifiers etc., refer to Metrolinx Standard Inverter Rectifier and Charger Specification 26 33 33

Diesel is the preferred fuel for backup generators. Where site and operational conditions do not allow for the use of diesel fuel, natural gas fuel powered generators are acceptable with Metrolinx approval.

Rectifiers shall be used for backup DC power in maintenance and layover facilities where required.

7.2.1.8 Design Requirements

The following table shows a list of items that are considered essential. The table shows both backup power system conditions (i.e. Generator + UPS or UPS only). The actual power draws shall be provided in the detail design.

Table 40: Backup Power Systems – Design Requirements

Backup Power Systems–Design Requirements				
Essential Load	WITH Generator		No Generator	
	Diesel Generator	UPS System	UPS System	
Exit signs–buildings, tunnels and similar structures (LED type)	x	x	x + Life Safety	
Public Address System	x	x	x	
CCTV System	x	x	x	
Any additional rack in the Comms. Room	x	x	x + Life Safety	
GO Transit telephone system	x	x	x	
All Passenger Elevators and shafts	x		x	

Elevator controls	x		x	
Alarm Monitoring Systems	x	x	x + Life Safety	
Lighting				
Tunnels, bridges and stairwell illumination (at least 1 fixture on normal power)	x	x	x + Life Safety	
Electrical Room Illumination (at least 1 fixture on normal power)	x	x	x	
Communications Room Illumination (at least 1 fixture on normal power)	x	x	x	
Service Area Illumination	x	x	x	
Waiting Area Illumination–minimal	x		x + Life Safety	
Platform Lighting (Train and Bus)	x			
Main Parking Lots (Surface Parking)	x			
Parking Structures	x			
Pick-Up and Drop-Off (PUDO) (Passenger Pick up and Drop off)	x			
Bus Loop Lighting	x			
Systems				
Ticket Sales Equipment	x	x	x	
Communications Equipment (White board, Pins etc.)	x	x	x	
Presto		x		
Door Operators (Building, Vestibules, Shelters)	x		x	

Mechanical				
Sump/Sanitary Pump	x		x	
HVAC for electrical & communication room	x			
HVAC for Service Counter and Waiting Area	x			
Water Heater Equipment	x			
HVAC and Exhaust of Elevator Shafts	x			

7.2.2 Generators

The generator shall be provided as a factory tested single unit and rated kW, 120/208 or 347/600 Volts, 3-phase, 4-wire, 60Hz, 1800 rpm. The generator shall be certified to CSA C22.2 No. 100, EEMAC MG1-22.40, and NEMA MG1, and shall meet the requirements of Ontario Electrical Safety Code, ESA, EPA, MOE, TSSA, along with all applicable local codes and regulations. For additional information on generators refer to Metrolinx Standard Backup Power Supply Generator Specification 26 32 00

7.2.2.1 Noise Matrix Table

Table 41: Generators Noise Levels

kW	dB(A)	Metres
≤ 150	65	7.0
175 to 500	75	7.0
600 to 1200	80	7.0

7.2.2.2 Diesel Engine

The engine shall be EPA compliant with maximum NOx plus HC of 3.87g/kw/hr.

ULC/CSA labelled double wall construction sub-base mounted steel fuel tank with an enough storage capacity to run the generator set at full load for 48 hours without refueling. The tanks and fueling system has to be accepted by TSSA and equipped with fuel paddling system.

7.2.2.3 Natural or Propane Gas Engine

(For Standby Generators ≤ 150 kVA)

- Include liquid cooled, spark ignition engine.

7.2.2.4 Minimum Required Accessories

- Line circuit breakers
- Dedicated load bank of 100% capacity for each generator (On Site)

There shall be a load bank for testing available on site rather than bringing a load bank onto site and connecting and disconnecting it. This load bank shall be able to be added in steps for testing up to 110 of the generators capacity. The controller shall have provisions for disconnecting a load bank (during exercise) if there is a loss of normal power by an Electrical and Mechanical interlock through ATS.

7.2.2.5 Exterior Enclosure

Table 42: Exterior Enclosure

Exterior Enclosure	
Exterior Weatherproof Enclosure:	<ul style="list-style-type: none"> • Owner's Common keyed • Compliant with CSA Standard • Sound Attenuated • Capable of withstanding 150mph sustained winds • Designed to resist rainfall angles of up to 45 degrees without interior flooding • Enclosure to be rodent and serpent proof
Construction:	<ul style="list-style-type: none"> • Aluminum panel construction • Power baked paint
Roof:	<ul style="list-style-type: none"> • One piece pitched roof designed to prevent water accumulation
Exhaust System:	<ul style="list-style-type: none"> • Internally mounted muffler and sound insulating Panels • Catalytic Converter: Include catalytic converter when defined by local codes
Doors:	<ul style="list-style-type: none"> • Door Hardware: Stainless steel • Doors shall be lockable by padlock • Hardware locks to be keyed the same • Door drip caps designed to keep moisture accumulation off the top of doors • Doors hinged to allow 180 degree opening
Sound Attenuation:	<ul style="list-style-type: none"> • Generator to be sound attenuated • Average dB level, refer to Table F-4
Block Heater:	<ul style="list-style-type: none"> • 1500 watt minimum
Space Heater:	<ul style="list-style-type: none"> • Include inside enclosure, thermostatically controlled to maintain 10 °C, except when engine is running, in accord with

	CSA C282, 208v
Motorized Louvers:	<ul style="list-style-type: none"> • Include on air intake to meet CSA C282, level 2 sound attenuated
Emergency Lighting:	<ul style="list-style-type: none"> • Include inside enclosure, 50 lumens, DC battery powered, two hour operation, in accord with CSA C282
Engine Fluid Containment Pan:	<ul style="list-style-type: none"> • Sized to 110 percent of available fluid in accord with CSA-C282

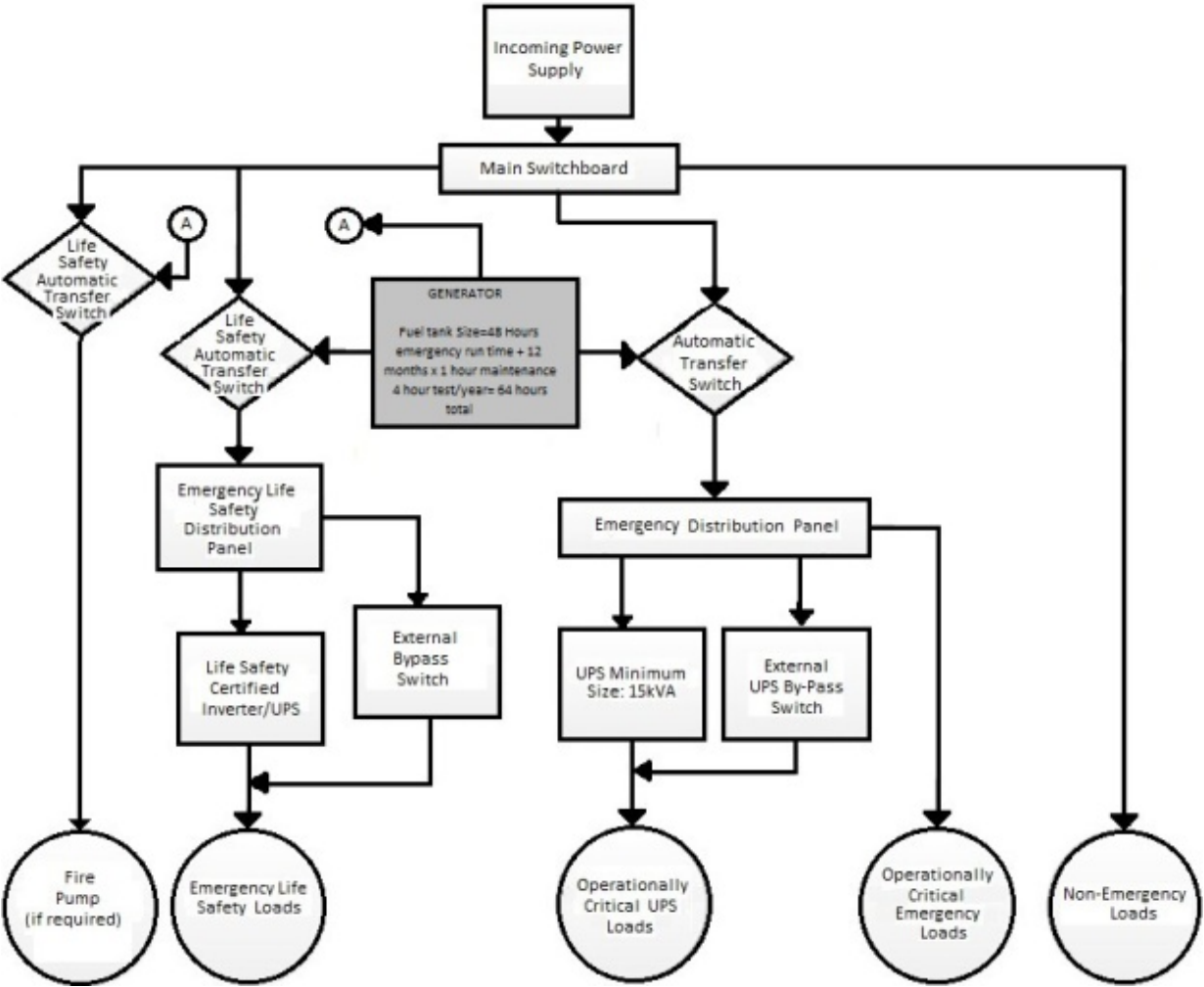

Figure 25: Emergency Power Distribution with Generator

7.2.3 Uninterruptible Power Supply (UPS)

Uninterruptible Power Supplies (UPS) are used to support Life Safety systems and protects computers and other sensitive electronic loads from power outages and other power anomalies. This Section

includes 3 phase \geq 3 kVA and Single phase $<$ 3 kVA, on-line, static-type, UPS system, comprising the following:

- Complete rectifier/charger-battery-inverter system with automatic static switch and maintenance by-pass circuit
- Central Monitoring System for all UPS units, along with proper interfacing with Metrolinx software, IT communication, and station operations shall be provided in order to display and control all required parameters.
- All intercommunication shall be through the Mod bus, BAC Net, etc.
- Input isolation transformer for UPS units, where technically required
- Connection of normal AC power from assigned terminals/switch/circuit breaker

The UPS shall be of commercial type and shall comply with relevant IEC, EIA, NEMA, NFPA 70, IEEE, ISO 9001, ISO 14001, UL-1778, CSA, FCC Class A, and Life Safety certified standards. Radio frequency interference (RFI) suppression shall be in accordance with CISPR and IEC 50091-2 recommendations. UPS shall be certified for use to support Life Safety Systems.

UPS assembly shall include a mimic diagram with digital and LED displays, indicating instruments and control devices, in true relative positions.

- System overall efficiency shall be not less than 92% at full load and 91% at half load
- Noise level of complete assembly is not to exceed 55 dB (A) at 1.0 m distance anywhere within the room that the UPS is located
- The system shall have an external maintenance bypass that will allow the removal and replacement of the UPS without rewiring.
- The Voltage supplied to the UPS shall be the voltages on the output of the UPS
- The UPS is to be located inside the main Electrical Room

7.2.3.1 Rectifier/Charger

For further information refer to Metrolinx Standard Inverter Rectifier Charger Specification 26 33 33.

7.2.3.2 Battery

High rate discharge, heavy duty, industrial, high impact resistant, clear plastic encased, sealed (gas recombination) type cells with automatically re-closing explosion proof safety vents.

- Ampere-hour rating shall be sufficient for UPS + Generator period specified with all inverters operating at full rated output, to a discharge limit of not less than 1.65 V per cell

7.2.4 Inverters

For further information refer to Metrolinx Standard Inverter Rectifier Charger Specification 26 33 33.

7.2.5 Transfer Switch (Automatic and Manual Bypass Switch)

7.2.5.1 General Requirements

The transfer switch shall be 120/208 or 347/600 V, 4 wire, 3 phase, 100% rated in Amperes for total system transfer including control of motors, electric-discharge lamps, electric heating, electronic and tungsten-filament lamp load. Switches rated 400 A and below shall be suitable for 100% Amp

loads. Switches rated above 400 A shall be suitable for 80% Amp loads.

Automatic transfer switch shall be rated for continuous duty or repetitive load transfer switching. The bypass-selector switch shall provide operating positions: Bypass Normal, Bypass UPS + Generator, and Bypass Open.

A two-way bypass isolation switch shall provide manual bypass of the load to either source, permit isolation of the automatic transfer switch from all source, and load power conductors. All main contacts shall be manually driven. Electrical and Mechanical interlock arrangements utilizing electrically driven contacts are prohibited. The manual bypass handle will provide two operating modes: Bypass Open and Bypass Closed. Bypass to the load-carrying source shall be affected without any interruption of power to the load (make-before-break contacts). Load break-type bypass for ATS test and isolation shall not be acceptable. In the bypass open mode, bypass contacts shall be open so they will not be subjected to fault currents. For additional information on transfer systems refer to Metrolinx Standard Transfer Switch Specification 26 36 23

7.2.6 Distribution of Primary and Secondary Sources

In general, loads shall be locally fed from power panels, distribution panels, and motor control centers. The electrical rooms, other than the main electrical room, shall service the area around it. (i.e. electrical rooms in station building should supply power to the station building only, or panels in communication rooms shall service only the communication equipment. General lighting and system circuits shall be alternately circuited to maintain partial lighting in the event of circuit failure. The same principle is to be used in communications that have a failure or maintenance on one component and will not remove coverage of the area. This item shall be verified upon commissioning.

7.2.7 Stations & Facilities

Table 43: Electrical Requirements at Stations and Facilities

Feature	Design Requirements
Studies	<p>The following studies need to be completed for design:</p> <ul style="list-style-type: none"> • Short circuit • Protective device • Device evaluation and arc flash hazard with coordinated ground fault protection • Electrical, for information on Arc Flash Hazards and labeling • Feeder plus main brace feeders on the main switchboard
System Voltages	<p>Ensure that system voltages are adequately selected.</p> <p>Provide appropriate main incoming service and transformer.</p>
Power Factor Correction System	<p>Provide a power factor correction system with the following characteristics:</p> <p>Capacitors in banks, automatic switching of banks, maintain power factor between 0.9 and 1.0.</p> <p>Ensure that power is supplied by the nearest available utility freestanding</p>

	enclosure, located near the main switchboard.														
Utility Power Failure	In the event of a utility power failure, provide emergency power by means of a standby diesel generating set or a group of generator sets connected to a common bus. Provide an uninterruptible power system for critical components.														
Electrical Handholes	Electrical handholes shall be precast concrete and designed for heavy traffic areas. Cast iron covers shall be bolted down. All metal components are to be grounded, except the cover.														
Surface Mounted or Suspended Equipment	Provide galvanized steel mounting channel for all surface mounted or suspended equipment. No equipment is to be mounted directly to any wall or structural element.														
Enclosures	Provide enclosures with the following characteristics: <ul style="list-style-type: none"> • Sprinkler proof, NEMA type 1 (dry and damp) • NEMA Type 4 (outdoor and wet) • 100mm concrete housekeeping pads for floor mounted equipment, disconnect switch at each motor 														
Disconnect Switches	Provide dedicated disconnect switches at electrical equipment.														
Grounding System	Provide a grounding system consisting of 19mm copper clad steel ground rods and bare copper conductors around the perimeter of the building.														
Electrical Equipment Connections	Major electrical equipment connected to systems at 600V and higher to be connected to ground system through a minimum of two (2) paths														
Lighting System	Provide a lighting system to be designed to IESNA recommendations for industrial facilities with the following characteristics: <table border="1" data-bbox="555 1381 1429 1841"> <thead> <tr> <th>Area</th> <th>Specification</th> </tr> </thead> <tbody> <tr> <td>Exterior circulation areas</td> <td>30 lux</td> </tr> <tr> <td>Exterior parking areas</td> <td>30 lux</td> </tr> <tr> <td>Pedestrian gates</td> <td>100 lux</td> </tr> <tr> <td>Building entrances and exits</td> <td>100 lux</td> </tr> <tr> <td>Interior repair garage, general</td> <td>500 lux</td> </tr> <tr> <td>Interior repair garage,</td> <td>750 lux</td> </tr> </tbody> </table>	Area	Specification	Exterior circulation areas	30 lux	Exterior parking areas	30 lux	Pedestrian gates	100 lux	Building entrances and exits	100 lux	Interior repair garage, general	500 lux	Interior repair garage,	750 lux
Area	Specification														
Exterior circulation areas	30 lux														
Exterior parking areas	30 lux														
Pedestrian gates	100 lux														
Building entrances and exits	100 lux														
Interior repair garage, general	500 lux														
Interior repair garage,	750 lux														

	workbenches	
	Bus garage areas	300 lux
	Utility areas	200 lux
	Office areas	400 lux
	Emergency and night time lighting	20 lux
Lighting Control	<p>Control interior lighting by local switches, occupancy sensors and lighting control system.</p> <p>Control exterior lighting by means of a photocells, occupancy sensors, central over-ride switches and/or contactors with a manual override; provide a computer based lighting control system to switch various lighting circuits through the building.</p>	
Receptacles	<p>All receptacles are to be duplex type spec grade to code use.</p> <p>Receptacles are to be located in the following places:</p> <ul style="list-style-type: none"> • Offices • Control and Electrical Room • On a dedicated circuit, at each workbench • On the roof adjacent to each HVAC unit • GFCI in wet and outdoor locations • Distributed equally along the building perimeter • Pendant cord mounter single receptacles in the repair garage and the front and rear of each hose location 	
Welding Outlets	Welding outlets shall be installed at appropriate location for supplying power to portable welders.	
Traffic Signals	Provide traffic signals as required near the entrances of the facility.	
Fire Alarm Systems	Multiplex fire alarm system to be provided.	
Storage Garage	Lighting not to interfere with structural components, gas lines, power lines (easily accessible for maintenance).	
Stair Shaft	Lighting to be easily accessible for maintenance	

7.2.8 Service Duct Banks

Service duct banks shall conform to OESC (Ontario Electrical Safety Code) latest edition inside property

line, or rail corridor per AREMA, CSA Standard C22.3 No. 7 Underground Systems, and OESC, coordinate with local Hydro and Bell for area having jurisdiction and for utility requirements.

Provide concrete encased duct banks in heavy vehicular areas and fire routes. Minimum 30% spare conduits with ground wire and pull-cords shall be provided in duct banks for future use, coordinate with Metrolinx.

7.2.9 Wiring Methods

7.2.9.1 Raceways and conductors

Raceways and branch circuitry shall be implemented to minimize failure of a complete system due to failure or malfunctioning of any single electrical component. Distribution minimizing conductors of different circuits sharing common raceways and pull-boxes, etc., shall be implemented. Raceways selected shall suitably resist mechanical damage and environmental deterioration effects. In particular, special attention shall be applied to corrosion inhibitors and protective coatings or treatments on surface mounted conduit in underground areas (e.g., tunnels, below grade electrical rooms, Bridges and parking structures etc.).

A minimum 12 AWG stranded copper wire green insulated RWU90 below grade and RW90 above grade shall be placed inside each raceway. This wire is to be used as a tracer wire inside a buried raceway for the purpose of locates after installation.

In addition, slack wire shall be provided. In all runs, the amount of slack shall be no less than 1.0m each termination point and 600mm in each pull point. Access wire is to be neatly coiled and be available for future use.

Drip loops shall be provided on all outside hanging raceways or conductors.

Refer to Metrolinx Standard Specifications: Rail Corridor Raceway Requirements 27 05 41, Raceway for Electrical Systems 26 05 34 and Electrical Conductors and Cables 26 05 21.

7.2.9.2 Conduits

Rigid galvanized steel conduit, or other Metrolinx approved cabling methods shall be used for all exposed work in normally dry areas not likely to present corrosion problems. Rigid steel or rigid PVC conduit may be used embedded in slabs where high impact protection is required. Rigid non-metallic conduit shall be used below ground, either direct buried or concrete encased.

PVC or epoxy coated rigid galvanized steel conduit shall be used in areas that can have condensation on metal or corrosion problem areas. Conduit, having a minimum of 53mm shall be used in parking lots when deemed necessary. Concrete encasements shall be provided for bus loops, road crossings, and railway Right-of-Ways. In finished areas, all conduits shall be concealed.

Refer GO Standard specifications for detailed requirements

7.2.9.3 Cable Trays

Where required, hot dip galvanized cable trays shall be ladder type; steel or aluminum or non-metallic as required for the application, complete with vertical barriers to separate systems or cables as required. Class shall be selected based on conductor weight plus 50% spare capacity as a minimum. Cable trays to be cantilever-supported for ease in installation of cables. Fire barriers of multi-transit type shall be provided at firewalls and fire separations, and shall be in accordance with the O.B.C. and CAN4-S115-M.

Types of Cable trays to be used:

- Wire Cable Trays: Used under raised floors
- Ladder Cable Trays: Used in Electrical/Communication Rooms
- Enclosed Cable Trays-Cable bus from transformers to main substation switch gear, outdoors

7.2.9.4 Wire and Cable

All conductors shall be stranded copper. Conductors smaller than No. 12 AWG shall not be permitted for lighting or motor branch circuit wiring, except that No. 14 AWG multi-strand type conductors may be used for control circuits only. Provide appropriate connection for terminating and standard wire.

Conductors shall have a minimum insulation temperature rating of 90°C, but design shall be for 75°C. All conductor insulation shall be colour coded.

An approved transition method shall be established when different gauges of wire are to be terminated together.

7.2.9.5 Responsibility

The Consultant shall specify responsibility for wiring and equipment connections. Examples: For voice-activated intercoms, the type of wiring is to be as recommended by the equipment supplier, and is to be installed by the electrical contractor, but connected by the equipment supplier. For the P/A, CCTV, and security systems, the electrical contractor shall provide conduit with pull-strings, and the equipment supplier shall install wiring and the equipment, making all connections, testing and commissioning. Any equipment customization shall have appropriate seals from approved standards authority.

7.2.9.6 Enclosures

Enclosures shall be selected for the environment in which they are intended to be installed. In general, enclosures for indoor, dry application shall be EEMAC sprinkler proof type 1 or type 12 where applicable. Enclosure for damp and wet areas (e.g., exterior boxes exposed to the weather, tunnels and escalators or elevator pits) shall be EEMAC type 4x.

- Where installed in public areas, all enclosures, cover-plates, outlets plates, access panels, and handwells shall be provided with method of securing doors and covers. All enclosures and panels shall have a common key and in an enclosed, protected area where possible
- Manholes and handholes shall be located remotely from doors and main road and pedestrian traffic areas
- Electrical and communication pull points such as manholes or boxes shall have a maximum 45m distance between manholes
- No splices are permitted below grade
- Underground conduits entering Mechanical, Electrical and Communications Rooms from the exterior shall be sloped to ensure positive drainage away from room
- Underground raceways entering any Mechanical, Electrical or Communications Room shall be interrupted by a drained manhole or handhole within 3000 mm of the room
- The minimum opening in the top of the handhole shall be no smaller than 460 mm
- The lip of the handhole and manholes shall be identified as to the type of service within by means of grooves cut into the collar of the handhole or manhole.
- These markings are on the collar shall be 2 grooves; 3 mm deep for communications in the direction of conduit in and out and 1 groove; 3 mm deep in the direction of conduit in and out for

electrical

- All electrical or communications handholes placed in the path of vehicular traffic or snow removal equipment shall be OPSD-2112.040 with OPSD-401.030 covers. If OPSD-2112.02 handholes are used, the covers shall be reinforced

7.2.10 Relay Protection and Metering

Relays shall have RS485 communication port and connectivity to monitoring system using Modbus RTU protocol as a minimum. Communication ports of relays and meters on the bus shall be daisy chained from breaker cell to breaker cell and connected to a separate terminal block for connection to a SCADA system.

Phase overcurrent and ground fault devices shall be coordinated such that ground faults, short circuits, or overloads will trip only the immediate upstream protective device from the point where the fault or overload occurs.

The Preliminary Arc Flash hazard study analysis shall be submitted along with the design drawings prior to the co-ordination study. The preliminary arc flash study shall be used to modify the design in order to minimize the hazard. The study shall also be used for the floor boundary marking. The Preliminary Short Circuit, Load Flow, and Coordination study analysis shall be submitted with design. The final studies shall be provided after purchasing of equipment.

Dedicated incoming digital metering shall be provided, beside Hydro metering, and shall measure true RMS current, voltage and display and provide 2 years history capabilities per phase.; Volts, Amps, kW, KVA KVAR, Pf, Hz, kW demand and peak. Communication port shall be provided; Meters shall be mounted at eye level (approximately at 5'-6" A.F.F) Metering devices shall be housed in a separate compartment enclosure, have no exposure to 600 Volt bus or terminators. Contractor to obtain validation certificate from Hydro Utility for the meter installed on behalf of the owner.

Surge Protective Devices (SPD, formerly known as TVSS), Lightning, Phase Over & Under Current and Ground Fault Protection shall be provided as required for protection and safety of building, equipment and personnel. SPD is to be distributed through the distribution system.

Dedicated incoming digital metering, besides Hydro metering, and sub-metering, shall be provided, and shall measure true RMS current, voltage, and display, minimum 3 years history capabilities. Units to be measured: per phase Volts, Amps, also kW, KVA KVAR, Pf, Hz, kW demand, and peak.

7.2.11 Receptacles

Receptacles shall be specification grade suitable for back and side wiring and complete with wire ground terminal. Receptacles shall be 20 amp 120 volt duplex non-locking grounding type (CSA configuration 5-20R) in service and public areas. Stainless steel face plates shall be used throughout. Twist lock receptacles and special coloured ground receptacles to be used in communications.

Receptacles shall not be on lighting circuits, and there shall be no more than six (6) receptacles per circuit in public areas, and no more than four (4) receptacles per circuit in service areas.

In general, building areas—janitorial outlets are required for cleaning and maintenance. In public open areas, receptacles shall be spaced at 5 m centres maximum, and at ceiling level for Christmas Lights as directed by GO transit. Tunnel and exterior building receptacles shall be GFCI type outdoors, located at spacing to suit 15 m extension cords or as required by GO user groups during detail design review.

If switched receptacles are required, or receptacles on UPS, these shall have a unique standard colour identifying the type of receptacle and the use at the site. The colour or marking shall differentiate regular, regular backed up, UPS, and switched or controlled receptacles.

Other receptacle requirements:

- Electrical/mechanical rooms—minimum 2 receptacles per room
- Station attendant room
- Elevator and escalator machine room, as required by Code
- Maintenance facility, shop and garage receptacles shall suit equipment requirements
- Maintenance/Janitorial – dedicated receptacle located above the AOCS unit to the right side. Confirm cable length of selected system prior to installation and ensure stress-free connection of the provided power cord. Identify circuit number and source Electrical Panel on receptacle plate.
- Receptacles shall also be provided for tenants and vending machines as required
- Communications room—minimum of 4 receptacles with 2 on emergency power

Refer to Metrolinx Standard Electrical Receptacles and Plugs Specification 26 27 26.

7.2.12 Switchboards

Factory assembled, dead front, metal enclosed and self-supporting switchboard. Complete with line and load side terminations

Bus material to be copper, silver-plated

Bus bracing minimum 65 ka rms

Enclosure: CSA type 2, indoor use equipped with arc flash reduction protection

Control compartments to be installed on front of the board away from buses

Future Provisions: fully equipped spaces for future devices with bussing and bus connections suitably braced for short circuit currents

Allow for 25% spare breakers and 25% spaces on new installations

Refer to Metrolinx Standard Switchboards and Panelboards Specification 26 24 13 and Low Voltage Switchgears Specification 26 23 00

7.2.12.1 Service Entrance Circuit Breakers

Provide Sensor and trip plug, solid-state trip circuit breakers, 100% continuous duty rating, factory mounted. Coordination study shall be provided. All service entrances, 1200 amps and above shall have ground fault protection downstream to the loads.

7.2.12.2 Monitoring and Metering

Provide dedicated digital monitoring meters system and sub-meters c/w remote communication capability and capable of storing data for minimum 3 years. All metering shall be part of the BAS system.

7.2.13 Panelboards

Shall be flush or surface mounted as required, complete with hinged locking door and flush catch, and finished with corrosion-resistant primer, equipment gray. Surface mounted panelboards shall be installed on unistrut galvanized steel framing channels with 75 mm clear between back of panelboard and wall. Where practical, panelboards shall be grouped in proximity. Swing-door-style inner door trim panelboard shall not be used.

Panelboard shall be copper bus type, with full capacity solid neutral design and sequence style bussing, composed of an assembly of bolt-in-place moulded case circuit breakers with thermal and magnetic trip and trip- free position separate from either the "ON" or "OFF" positions. Multi-pole circuit breakers shall have common simultaneous trip.

Provide dedicated relay panel, smart panels, powerlink panels, multi circuit monitoring panel or equivalent, for circuit control, energy saving and monitoring capability. Requirements shall be established on site-by-site basis together with Metrolinx.

Refer to Metrolinx Standard Switchboards and Panelboards Specification 26 24 13 and Low Voltage Switchgears Specification 26 23 00

7.2.14 Switches and Disconnects

Refer to Metrolinx Standard Disconnect Switches Specification 26 28 23 for detailed requirements

7.2.15 Switchgear

All components at the completed assembly shall be CSA approved and bear a CSA label. Dimensional Coordination: Verify that dimensions of switchgear do not exceed spaces provided.

Digital Metering and Relaying: Provide dedicated power monitoring meters system and sub-meters c / w remote communication capability and capable of storing data for minimum 3 years

Refer to Metrolinx Standard Low Voltage Switchgears Specification 26 23 00 for detailed requirements

7.2.16 Building Automation System (BAS)

The site BAS system Head end shall be Located in the main Communication room. Access to the BAS is to be through access network portal.

Refer to Metrolinx Standard BAS Performance Specification 25 05 10 for detailed requirements

7.2.17 Monitoring and Controls

7.2.17.1 Power Circuit Breakers

Refer to Metrolinx Standard Circuit Breakers and Fuses Specification 26 28 00 for detailed requirements

7.2.18 Transformers

Transformer types:

- Current Transformers (CT)
- Voltage Transformers (VT)
- Low Voltage Transformers

Refer to Metrolinx Standard Liquid Filled Transformer Specification 26 12 13 and Dry Type Transformer Specification 26 12 16 for detailed requirements

7.2.18.1 Circuit Overload Protection

Refer to Metrolinx Standard Circuit Breakers and Fuses Specification 26 28 00 for detailed requirements

7.2.19 Motors and Controls

Motor Starters

Provide auto mode for all life safety listed on Table F-3.

Motor Control Centers (MCC)

In general, circuit breaker type combination starters in Motor Control Centres shall be used for 600-volt motors. However, individually mounted circuit breaker type combination starters may be used where practicable. All starters shall be magnetic, full voltage start, single speed, non-reversing type (except when the driven equipment characteristics or power company limitations require other types), and shall be equipped with an additional one open and one normally closed contact for possible remote status indication at the Motor Control Centre.

Each starter shall be equipped with 120-volt transformer and three thermal overload relays. To be able to be monitored, solid state overload relays to be equipped with controller capable of remote communication. Each motor starter shall have stop and start button and/or hand/off/auto switch with indicator lights. A local heavy-duty unfused isolating disconnect shall be provided within sight of the motor to safely disconnect equipment for servicing.

Refer to Metrolinx Standard Specifications: Motor Starters and Contactors 26 29 10 and Motor Control Centres 26 24 19 for detailed requirements

7.2.20 Monitoring and Controls

Installation of supervision monitoring and control systems at selected locations, will monitor status of equipment, power quality and demand, control and will provide capacity for automated reporting. Metrolinx Main Computer Centre will monitor the selected sites via the Metrolinx Network. Meter additions are considered in designated locations.

- Digital Metering devices shall be housed in a separate compartment having no exposure to the 600 Volt bus or terminations. Metering compartments shall be installed such the metering unit is viewable at approx. 5' –6".
- Metering shall be as specified on specification sheet. In addition, each MCC shall have an incoming Power Measurement meter. The meter shall be complete with Modbus RTU communications module, and 2 PT's and 3 CT's. Provide fuse blocks for PT's and shorting blocks for CT's. Only dead front fuse holders shall be utilized in metering circuits. One (1) or a maximum of two (2) Internet Static (IP) addresses 10Mb will be required per selected Central Office. For each new installation, inform Metrolinx IT representative that a new IP address is required
- The Main Meter/Controller is set up with BACnet network Card
- Communication is established through Metrolinx Corporate Network utilizing TCP / IP
- Design and As-built Drawings shall be done in AutoCAD at a minimum.
- Send CAD design to Metrolinx representative to allow for commenting and acceptance.

7.2.20.1 Power Measurement Controller

At selected offices and sites, install Power Measurement Controller, providing per-phase power monitoring, analysis and control capabilities, at each low voltage incoming main distribution point.

The following option shall be included depending on the applications:

Limit the required Digital Inputs and the Return Input in consideration of:

- Connection with other Counters such as Gas Meter, Water Meter, etc.
- Counters taking in consideration that they can use the same return Input
- Synchronization with Hydro Meter

7.2.20.2 Electric Power Monitors–Installation

Coordination with Metrolinx Technical Support Representative:

The installation of power monitoring units in a Metrolinx Main Computer Centre office (number and models of units to install, location of units,) must be coordinated with a representative of the Metrolinx Technical Support group.

7.2.20.3 Physical location, Communication (i.e. BACnet network)

Supply a minimum 6"x6" box on a wall as close as possible from the Main Power Measurement Controller master unit in electrical room.

Supply a minimum 19mm conduit and a communication cable.

Between the box and the Main Power Measurement Controller master unit, install a 19mm conduit and cable inside. The length of the cable must be 25' at the maximum.

7.2.20.4 RS-485

Starting from the Main Power Measurement Controller master unit, install a minimum 19mm conduit between all powers monitoring unit in order to create a daisy chain. The sequence used to link all those units has no importance.

Use #12AWG, 2 conductors cable with metal shield, type FT-4 to link all the power-monitoring units.

The metal shield in the daisy chain sequence must be continuous.

When connecting the cable to the RS-485 port, the shield of the incoming cable must be linked to the shield of the outgoing cable.

The metal shield in the daisy chain sequence must be connected to the terminal of only one (1) power-monitoring unit. This is to avoid a ground loop.

7.2.20.5 120V Power Feed

The 120V power feed of the power monitoring devices must continuous, i.e. come from a UPS or an inverter.

Install a minimum 19mm conduit between the UPS or inverter and the Main Power Measurement Controller master unit.

Starting from the Main Power Measurement Controller master unit, install a minimum 19mm conduit between all powers monitoring unit in order to create a daisy chain. The sequence used to link all those units has no importance.

Connect the 120V power feed of all power monitoring units to one UPS or inverter circuit of 15A.

Use a #12AWG cable, type multi-strand, for the 120V power feed.

7.2.20.6 Commissioning

When the installation activity performed by the electrician is done and that all monitoring units are functional, commissioning of these units must be performed.

An agreement with GO/ Metrolinx has to be signed for commissioning activities.

Commissioning agent to be present on site and verify the quality of installation, program and calibrate the monitoring units, verify the communication between the units and between the Power Measurement controller master unit and the server.

7.2.20.7 Power Monitors–Monitoring Program

Install Monitoring Program to locally monitor all Power Meters at selected sites.

7.2.21 Wayside Power

Wayside power and control requirements are for the storage of trains. Wayside power may be 600 V ac or 480 V ac depending on the consist being stored at the site. Refer to Metrolinx Standard Drawings.

EV Charging EV charging shall be provided for operations fleet of vehicles.

Provide empty conduit, complete with #12 AWG green insulated grounding conductor RWU90 for easy tracing terminated in a handwell, sized as per OESC (Ontario Electrical Safety Code) but, not smaller than 2" (50mm)

7.2.22 Service Rooms Requirements (General)

7.2.22.1 Design Considerations

Incoming utility services at Metrolinx facilities shall be located in the primary Substation and/or Electrical Room, kiosk, bunker, Hub and Communications Room.

All Electrical Rooms and Communications Rooms shall be dedicated and not be shared with other functions, including, but not limited to: custodial, access services, communications, electrical, mechanical and storage.

Access to Electrical Rooms and Communications Rooms via (pass through) shall be avoided.

The main Electrical Room and the main Communications Room shall be located next to each other with exterior access.

Electrical Room, Hub, and Communications Room walls shall not have windows, skylights, roof access hatches/doors, etc.

Locating Electrical Room and Communications Room on perimeter curtain walls where windows comprise the entire surface of walls shall be avoided.

The Service rooms' floor plan shall always be rectangular or square in shape. The room shall never be L-shaped, triangular or any other odd shape. Electrical Room, Hub and Communications Room shall always be a one level room and preferably above grade. The room shall be sized for the known equipment with a provision for a minimum of 25% extra wall space to accommodate future additional equipment.

Drawings shall indicate to scale the arrangement of allocated equipment inside Electrical Rooms, Hub, and Communications Rooms, including spaces and clearances. Elevation drawings shall show to scale all related wall mounted equipment for each wall.

A minimum 1 m clear working space shall be provided in front of access points, which may occur behind

equipment and patch panels, and in front of and behind racking. Racking shall not be positioned closer than 1 m from any wall.

A wall mounted, flip down work surface will be provided in each communication room. The work surface will be 25.4 mm thick, 762 mm wide by 610 mm deep, solid wood, plastic laminate on both main surfaces with a vinyl self-edge. The work surface will be mounted at a height of 915 mm above the finished floor. The location of the work surface will be adjacent to the main communication cabinet rack and maintain all regulatory clearances from exit and equipment as required by code when in the open position. One (1) duplex receptacle and one (1) RJ-45 data connection will be provided at the workstation and mounted above the tabletop in the open position. Provide heavy duty stainless steel mortise hinges, mechanism to hold the table open and blocking in the wall as required.

No liquid piping, steam piping, drainage piping, and/or dry liquid piping shall pass through or within walls of any Electrical Room, Hub, or Communications Room, except for refrigerant and condensate piping for the A/C unit in the room. Sprinkler systems that are located in these rooms shall be a dry type pre-action system.

All Electrical Rooms, Hub, and Communications Rooms shall have a break in all ducts within 3000 mm of the building by a junction box, handhole, or manhole. All manholes or handholes shall be designed so that water is drained away. All ducting shall have the piping slope away from the room.

Ducting in the Electrical Room, Hub, and Communications Room shall be tray and rigid galvanized steel conduit above floor. EMT is accepted only with compression type connectors (screw connectors are not allowed).

7.2.22.2 Design Requirements

7.2.22.2.1 Walls

The building envelope shall be insulated to meet or exceed ASHRAE 90.1 requirements. Walls shall extend from finished floor to the structural ceiling and shall be structurally sound for wall-mounted equipment. Concrete cinder blocks shall be used on all walls where poured concrete structural walls are not present. Studded walls are not permitted. Walls shall be fire-rated as required by the applicable codes and regulations and shall be painted with a minimum of two coats of non-dust producing white or light gray paint. For rooms with Plywood on the walls the Plywood must be fire rated and have two coats of fire retardant paint.

1200 mm wide x 2440 mm x 21 mm A-C grade or better fire retardant plywood, void free, shall be installed all around Communications and Hub Room walls for wall mounted communications equipment. The bottom of plywood shall be mounted 150 mm above finished floor. Paint plywood with a minimum of two coats of fire-retardant white or light gray paint. The fire rating designation shall be placed in an area that is visible and shall not be painted over.

7.2.22.2.2 Floor

Poured concrete sealed floor shall be provided in Electrical Room, Hub and Communications Room. Floor finish shall be antistatic dissipative light gray epoxy sealer, applied per manufacturer's published specifications. A 100 mm rubber wall base shall be provided. No floor drain is allowed.

7.2.22.2.3 Doors

- The doors shall be at least 915 mm wide x 2135 mm high and shall be hollow metal slab type (no windows) with hollow metal frames
- Double or oversized doors shall be provided for rooms that have large equipment to be installed and maintained
- If the door to the Room is in a fire separation then the door shall have an appropriate fire

resistance rating per O.B.C.

- When feasible, the rooms shall have exterior access but doors shall not open onto a public space
- The Electrical Room and Communication Room within a parking structure may be exempt from having an exterior door access, providing access to the Room door is unrestricted
- Doors shall not open in to the path of vehicle traffic
- Access shall be provided through GO Transit uniform master key system and a centrally controlled alarm keypad and proximity access device system, with an access override feature
- The door shall be lockable from outside only

7.2.22.2.4 Ceiling

- No suspended ceiling shall be installed
- Finished ceiling minimum height shall be 3050 mm (10'- 0")
- Prime and paint the ceiling with a minimum of two coats of non-dust producing paint. White paint is required.
- Where OWSJ are present, prime and paint all exposed structures to meet flame spread and smoke developed ratings designated by local Code requirements

7.2.22.2.5 Flood Prevention

Locate Electrical Room and Communications Room above any threat of flooding. Avoid locations that are below grade or adjacent to potential water hazards (restrooms, tunnels, etc.). Roof drains and pipe penetrations into the room shall be avoided.

7.2.22.2.6 Fire Protection

Fire-stop all room penetrations (cables, pipes, pathways, trays, conduit slots). Ensure that the fire-resistance rating of installed fire-stopping assembly shall be not less than the fire-resistance rating of surrounding floor and wall assembly to match the corresponding fire rating of fire separation.

For fire suppression, install a hand held 10lbs CO₂ (10 B:C rated) fire extinguisher, with current certification, meeting NFPA 10 requirements. The extinguisher shall be wall mounted on the latch side of the entry door and installed in accordance with manufacturer's recommendations. All panels, boxes, and conduit shall be sprinkler proof if required.

7.2.22.2.7 HVAC

Heating, ventilation, and air conditioning of Electrical Room and Communications Room shall be provided by a heat pump AC unit with the following features:

- Low ambient cooling
- Heating at -25°C
- R 410A refrigerant
- Variable compressor speed

A fan-forced heater shall be provided as a redundancy in case the heat pump does not provide enough heating during the extreme cold days. Because a Hub Room is smaller than a typical Communications Room and a bunker or kiosk is smaller than an Electrical Room, a heat pump with hyper-heating may not be available on the market. If this is the case, a split A/C unit with ambient cooling would provide cooling and the fan-forced heater will provide heating. Control of both systems shall be central in order to avoid both systems fighting each other. The heat pump and heater shall be fed from the regular power panel

located in the Room. Temperature and humidity requirements are on a 24 hours, 7 days a week basis, regardless of the heat generated by normally operating electrical and communications equipment.

The required capacity shall be calculated based on the following:

- For sensible heat gain from electrical equipment use a minimum 5000 Watts per rack (in the Communications Room)
- Sensible heat gain from lighting
- Include the future growth of systems by 25%
- Determine heat gain/loss to the room from the outside (heat transfer through building structures, including solar load) g the following design criteria
- Outdoor temperatures

Use 2½% winter & summer design temperatures per Ontario Building Code for the geographical location. Indoor temperatures:

- Winter design: 15°C
- Summer design: 22°C D B with a maximum of 50% relative humidity
- An infiltration rate from outside of 0.5 air changes per hour
- A recirculation rate of 100% for the air conditioning system
- A safety factor of 5%

The air conditioning system shall be selected to suit the specific capacity by taking into consideration the room's very high sensible load factor. Heat loss calculation shall not include credit for equipment and lighting heat gain.

7.2.22.3 Emergency Cooling

Provisions for emergency cooling in communication and electrical rooms:

- Provide a 6" vent opening provision, secured from inside, for portable A/C unit in both electrical and communication rooms, venting to the outside
- Provide dedicated 120V, 20A, 5-20R and 120V, 30A, 5-30R power receptacles (generator backed-up) from dedicated circuit breakers for portable A/C unit, in Electrical and Communication rooms.
- Receptacles to be mounted at 300mm height above finished floor
- Contractor to provide Labels above receptacles stating: the respective Amps, panel and circuit numbers and "DEDICATED FOR PORTABLE A/C UNIT"
- Provide an exhaust fan controlled by a reverse acting thermostat and an override switch
- High/low temperature alarm
- All alarm inputs to be placed in Chubb System and BAS

The sequence of operations shall be as follows:

- When A/C unit fails and temperature starts rising, the high temperature sensor sends an alarm to the current corporate supplier of security and monitoring services
- Station Operations will be notified to send a portable A/C unit and the HVAC service contractor is notified to repair the broken A/C unit

- The ventilation system will then kick-in to help reduce the temperature until a portable A/C unit is installed
- Station Ops will install the portable A/C unit and switch off the ventilation system

7.2.23 Electrical Rooms

7.2.23.1 Design Considerations

Electrical service Substations are typical at GO/ Metrolinx Rail Service Centres but can occur at a large station, maintenance facilities or where ever else Metrolinx requires them.. For an example of a substation, see Standard Layover drawings. Install HVAC in all electrical rooms w/auto changeover.

Whenever possible there shall be one main Electrical Room that feeds the entire site, as it is the goal at most facilities to have only one utility power source. Sub Room(s) shall be strategically placed around the main Electrical Room to facilitate an efficient distribution of power to loads to boilers, tunnels, bridges, main and sub- structures (e.g. parking structures, stations, service and storage buildings and maintenance facilities), as required. Electrical closets shall be provided to minimize the number of home runs from distribution panels to their respective sub-panels or equipment loads, and to reduce the number of conductors and minimize voltage drop or in preparation for future requirements.

The typical Electrical Room at Metrolinx facilities shall include space for locating:

- Distribution panels, switches and boards
- Metering Cabinets
- Transformers
- Uninterruptible power supply (UPS)
- Transfer Switches
- Battery Pack backup emergency lighting above and beyond the generator backed up lighting and UPS lighting of the space.
- Automatic Transfer Switch (ATS)
- Data and telephone outlets
- A service-working station by the door with power and data connections
- The station shall be a cabinet-lectern combination sized to hold ANSI B drawings, to serve as a working surface and storage for drawings, manuals and onsite component and parts
- A minimum continuous 17 m of wall space is required for equipment installation

All wall installed panels and conduits or ducts shall be installed on strut channel mounting system. All floor mounted panels and equipment shall be installed on housekeeping concrete pads. The housekeeping pad shall be a minimum of 100 mm above the floor and shall extend beyond the equipment footprint as per manufacturer's requirements.

A non-fade single line diagram of the electrical system related to the room shall be framed and posted under a polycarbonate cover adjacent to the entrance of the Electrical Room. The diagram shall be legible from a distance of 1 m.

Provide markings on the floor showing the arc flash boundaries in around equipment and panels.

7.2.24 Communications and Hub Rooms

7.2.24.1 Design Considerations

All Communications Rooms shall be designed in accordance with ANSI/TIA/EIA-569-A-Commercial Building Standard for Telecommunications Pathways and Spaces.

The Room shall accommodate the following equipment (refer to IT Telecommunications and Systems Document for list of IT equipment):

- Network System Rack
- CCTV System Rack
- PA System Rack
- Passenger Notification System (PINS, Whiteboard, etc.)
- Telephone Infrastructure
- Two-way Communication Infrastructure (elevator cab intercom and information intercom)
- Fare Collection Equipment: Presto and legacy
- Alarm and Security Monitoring Equipment
- Fire Safety System
- Space Counting System (in parking structures)
- Building Automation System Server (all support systems shall be located appropriately with the equipment)

Communications Room shall be located next to the Electrical Room with exterior access if possible, within parking garages these rooms shall open onto the interior of the garage.

At facilities where the distance of cable runs exceeds 90 m (300 ft.) between the end device and accumulation point as deemed necessary by Metrolinx, Communications Hub Room(s) shall be implemented. Hub Rooms are satellite Communications Rooms, designed to accommodate a minimum of two floor-mounted racks. Hub Room's purposes are to minimize the number of home runs from remote devices to their respective head end equipment; reduce usage of optical fiber and associated equipment; concentrate the distribution of collocated devices; facilitate future implementation of Communications systems.

7.2.24.1.1 Mini Hub Rooms

Mini Hub Rooms shall be provided to span beyond the 90m limitations of Power over Ethernet (PoE) I&IT Architecture and in areas where devices are deployed in numbers that require consequential¹ infrastructure. Standalone cabinets, wall mounted or otherwise, shall not be used.

¹ Consequential infrastructure is defined as the use of multiples of support enclosures and devices, additional/costly components and resource and infrastructure intensive to install and maintain.

7.2.24.1.2 Interior

Mini Hub Rooms shall, at a minimum, be of sufficient size to house one full size network rack that is capable of pivoting to allow technicians to access the rear of devices which are mounted on the rack.

All interior walls shall be constructed from concrete block, and be finished with 23mm thick fire resistant plywood, void free, with two coats of white or light gray fire rated paint.

Doors for the Mini Hub Room shall be fire rated per applicable codes, and have the capability to be held

in the open position during maintenance periods.

The Mini-Hub Room floor shall be slightly raised to prevent pooling and be coated with an anti-static finish.

An HVAC system shall be provided by a heat pump type A/C unit, a fan-forced heater shall be provided as a redundancy. A multi-split unit may be provided for elevator area and Mini Hub Room, where feasible. A dedicated heater and condensing unit shall be located within the Mini Hub Room.

7.2.24.1.3 Power

Grounding shall be provided from a single point within the main Electrical Room utilizing the "HALO" distribution method. Grounding shall be provided to all systems, racking and supporting infrastructure within the room including doors and door frames.

Power panels shall be provided, minimum one UPS and one regular power.

Provide a cable tray and cable ladders to facilitate wiring infrastructure within the Mini Hub Room.

Two receptacles shall be provided on the cable tray above the network rack with each having a distinct and separate UPS circuit to provide power for systems within the rack.

Provide two wall mounted GFI receptacles on generator power for maintenance.

Illumination shall be provided in front of the racks and be tied to a hinge switch.

High/Low temperature sensors and access control utilizing Keypad/FOB for entry shall be implemented.

Power bars shall not to be used within the Mini Hub rooms.

7.2.24.1.4 Utilization

Platforms used by GO Transit are minimum 315m long. To provide infrastructure for the number of current and future systems, it is necessary to provide more than one Mini Hub Room.

Mini Hub rooms shall be located adjacent to elevator enclosures to maximize infrastructure support for all platform devices and adjoining tunnel and bridge area devices. When this location is not available or feasible, locate the Mini Hub Room at the closed end of a stairwell opening. All alternative locations shall be pre-approved by Metrolinx.

The Mini Hub rooms location shall not impede with passenger flow and be positioned so they don't disrupt sight lines to be compliant with CPTED.

Mini Hub Rooms shall meet or exceed rail corridor regulations and all regulatory items that apply.

7.2.24.1.5 Exterior

Exterior cladding shall match adjoining structural material palette to give a consistent, cohesive, uniform appearance. This includes the wall shared by the Mini Hub Room and an enclosure.

Where a Mini-Hub is located under a platform canopy, extend the exterior enclosure of the Mini-Hub Room to be continuous to the underside of the platform canopy. Where the location does not have a canopy, extend the exterior finish of the Mini-Hub Room to the height of the adjacent structure (elevator or stairwell).

For further information regarding Mini Hub Rooms refer to the Service Rooms Requirements (General) section of this document.

At multi-level parking structures, Communications Hub Room(s) shall be strategically placed directly above the main Communications Room and centrally located to meet the 90 m (300 ft.) cable run distance limitation. One Hub Room can serve more than one floor. In Parking Structures, careful planning is required when locating the Communications and Hub Rooms. Attention must be paid to

equipment placement within these rooms in relation to the structural ceiling elements. The required vertical clearance above the racks must also be taken into account. Ideally, cable trays shall be kept level, precast openings in structural “T’s” as determined by the structural engineer, to get to the sidewalls of the room.

Communications Room and Hub Room shall be dedicated and not be shared with other functions, including, but not limited to: custodial, access services, electrical, mechanical and storage. Access to Communications Room and Hub Room via (pass through) Electrical, Mechanical, Maintenance/Janitor Rooms, etc., shall be avoided.

For further information regarding Mini Hub Rooms refer to the Service Rooms Requirements (General) section of this document and the Electrical Communications Infrastructure Mini Hub Rooms drawing in the GO Standard Drawings and Specifications.

7.2.24.2 System Controller

The System Controller shall provide the following primary functions:

- Switches of audio channels to the required zone drivers
- The switching function shall be performed by the zone switching card
- Allows programming and testing through a RS 232 /RS 485 port
- Supplies power to the system processor, display and interface cards
- Four audio input channels that can each provide an audio output on any pre-configured group combination or manually selected zone
- Provision shall be made for an ALL Call broadcast to all zones simultaneously
- Appropriate Zone Driver and Zone Relay Cards for the requisite number of drivers/zones within the system
- The audio channels are interfaced to the driver input/output circuits by zone driver and relay cards
- Provides appropriate Paging Telephone interface
- Configurable automatic Day/Night audio level capability
- Automatic Daylight saving time adjustments

7.2.24.3 Room Construction

Room dimensions (minimum wall to wall):

Table 44: Minimum Room Dimensions

Location	Size
Communications Hub Room	3200 mm wide x 3600 mm long
Communications Rooms at stations and small to medium sized facilities	3200 mm wide x 4800 mm long
Communications Rooms at Large Facilities and/or Parking	3200 mm wide x 5400 mm long

Structures Note: Small, medium, and large size facilities are determined by the number of racks that are needed to house all equipment systems and varies per facility.	
For Type A Bus and Rail Facilities	3200 mm x 6600 mm Space for 6 Racks
Type B Bus Facilities	3200 mm x 5400 mm Space for 5 Racks
Type C Bus Facilities	3200 mm x 4800 mm Space for 4 Racks

7.2.24.4 Communications Connectivity

A minimum of nine (9) 53 mm (2") dedicated conduits shall provide connectivity from the Communications Hub Room to its respective Communications Room. If more than one Hub Room is required, then each Room must have its own direct dedicated set of conduits linking it to the Communications Room, which may be designed as a pass-through layout.

If more than one Communications Room on site, a minimum of nine (9) 53 mm (2") dedicated conduits shall provide connectivity from one Communications Room to the other. Refer to IT Telecommunications and Systems Document for list of equipment

7.2.24.5 Electrical Requirements

All communications equipment in the Communications Room shall be serviced by a dedicated 120/208 V 3 phase 4W 225 A panel located inside the Room, and fed from an UPS placed inside the Electrical Room. If 208 V service is not available, 120/240 V 1 phase 3W 225 A panels shall be used. There is one exception, Presto shall be fed from a dedicated 120/208 V 3 phase 4W 225 A regular generator backed up panel located inside the Room

All communications equipment in the Hub Room shall be powered from a sub-panel fed from the dedicated back-up electrical panel located in the Communications Room.

A dedicated electrical panel shall be provided for regular power inside each Communications Room. This panel grounding shall be connected to the Electrical Room grounding system.

All panels shall be sized to meet DRM requirements. All panels shall have remote monitoring and control of all circuits' capabilities.

All panels and boxes shall have NEMA ratings designations.

Half of the light fixtures inside Communications and Hub Room shall be powered from the UPS backed-up panel.

Heating and air conditioning of the Communications and Hub Room shall be generator backed-up only (no UPS back-up).

All panels, boxes, and conduit shall be sprinkler proof.

7.2.24.6 Power Outlets

Each communications equipment rack shall be fed from two independent tray mounted twist lock L-20R

single specification grade receptacles. Each such receptacle shall be fed from a dedicated circuit. Refer the IT telecommunications and Systems document for detailed specifications.

Communication racks are required to be on UPS.

See Presto subsection under Fare Handling Systems section for power requirements.

Provide a minimum of three (3) normal power 5-20R 120 V duplex receptacles, powered from three dedicated circuits, for maintenance and identified as such. These receptacles shall be wall mounted and not located on cable tray or cable ladders, as not to be confused with communication-dedicated receptacles.

Provide an approved for use power bar for the equipment mounted on the plywood backboard. Each connection on the power bar shall have nameplates to provide power tracing ease. The power bar shall be a multi-outlet raceway. All equipment connecting to the power bar shall have nameplates indicating model, capacity, and electrical data. Install equipment in accordance with manufacturer's recommendations.

7.2.25 Illumination

7.2.25.1 Lighting Design

This section addresses interior and exterior illumination and lighting design strategy for GO site and building facilities. The intent is to provide good uniform quality lighting design strategy that meets the locations application. The Lighting design strategy shall be applied as a sequential overlay of Guiding Principles; followed by lighting design considerations, lighting typology applications and selection criteria and individual lighting design requirements.

Lighting Design Guiding Principles → Design Considerations → Typologies → Design Requirements

Refer to Metrolinx Lighting and Controls Specification 26 50 00 for detailed requirements

7.2.25.2 Lighting Design Guiding Principles

- A cohesive and adaptable hierarchy of lighting
- Provide a consistent and flexible lighting approach across all sites will promote intuitive wayfinding----
- Utilize built site elements with internal lighting as beacons to support wayfinding
- Associate lighting types with the same conditions/activities at each element, to provide a recognizable visual language.
- The hierarchy of lighting is identified as:
- Areas of transition and boarding of Metrolinx services that are highlighted to enhance the experience
- Illuminated built structures that serve as lanterns and aid wayfinding throughout the site. The lighting shall provide comfort, feel and uniformity with accent lighting for points of interest and art.
- Pedestrian scaled illumination for areas of rest and waiting that promote activity specific design, comfort and feel of the space
- In areas of vehicular movement and parking, the lighting shall meet the BUG rating system, be uniform and have no glare.
- Durable and adaptable design with sustainable maintenance and operational efficiencies

- Use LED technology
- Integrate control systems and sensors to meet energy management goals and sustainable practices. Equipment shall be non-proprietary and shall not be a custom design.
- Shall guide customers through the sequence of unique customer journey touchpoints at a site
- Use lighting to articulate each site element's sense of place
- Highlight areas of transition to heighten the experience of movement
- Reinforce site order and hierarchy by emphasizing important zones with light that will match the activity of the space and the lighting levels needed for all users.
- Deliver an engaging, comfortable, and safe experience for the customer
- Use a variety of lighting types and methods to create ambiance and provide comfort
- Highlight significant edges of site elements—thresholds—to create a dynamic and engaging experience
- Provide lighting levels that ensure visual and physical comfort of customers. In noncustomer areas, the lighting levels shall ensure visual and physical comfort to perform required tasks.
- Use light sources with good colour rendering and colour temperature to support comfort, well-being and health.
- Highlight edges of train platforms and curbs to provide a high level of safety and legibility

7.2.25.3 Lighting Design Considerations

- The levels and quality of lighting for the various types of areas shall be as outlined to meet the latest edition of the Illuminating Engineering Society of North America (IES) Lighting Handbook, Ontario Building Code and Ontario Electrical Safety Code. They shall take into consideration the aging population and the needs for accessibility of all groups (e.g. CNIB recommendations). The lighting design shall be done by a qualified lighting designer.
- Illumination systems design shall incorporate requirements of: minimal maintenance, shall be energy efficient and readily accessible, designed for passenger safety and security
- Illumination shall be designed to provide visual comfort and minimum glare for GO staff and passengers.
- The illumination systems lighting levels shall be compatible with CCTV systems requirements.
- Building luminaries in public areas shall be integrated with the architecture
- Luminaries shall be in locations dictated by the architect in conjunction with the lighting designer, complementing daylight sources
- All luminaries must be accessible for maintenance and lamp replacement without having to construct special means of approaching the fixture
- The illumination systems component maintenance requirement shall be easy to access, tool-less maintenance, easily removed and replaced.
- Public area lighting such as tunnels, bridges, and station buildings, shall have LED Fixtures with quick connects / support system and safety chains. The fixtures shall come complete with pigtail plugs that connect to a twist lock receptacle or by a manufactures designed plug and play wiring system.

- Illumination sources whenever possible should not be visible to the public.
- Urban light fixtures for each station site shall be selected from one fixture family and matched to the uses and lighting types called for at each site element
- Wayfinding through each station site shall be supported by using fixtures that are common to the scale of the user wherever possible
- For example, for lighting fixtures on 6 meter poles shall look the same or very similar to the fixtures on the 12 m poles in look and shape. This is to provide a uniform look and feel throughout the site.
- Light fixture design shall be simple, elegant and contemporary
- Site lighting controls, including sensors and timers, shall be provided for all site element lighting where appropriate, and shall be integrated into the station building automation system
- Lighting controls shall support daylight harvesting where applicable
- Lighting controls shall support reduction when not occupied
- Lighting controls shall support dimming to Metrolinx levels
- Photosensors are to be located so that there is a direct view of the sun and that no shadows or obstructions will interfere with readings
- Occupancy sensors are to be provided in the following areas: Parking garage, tunnels, bridges, service rooms, outdoor lighting, offices and other areas as required
- Non-proprietary controls and occupancy sensors shall be used.
- Photosensors shall be provided for site lighting in the following areas
 - Bus platforms, including shelters
 - Surface parking lots
 - Station plaza
 - Rail platforms
 - Open bridges, including stairways
 - Closed bridges

Refer GO Standard specifications for detailed requirements.

- Lighting in enclosed stairways and parking garages shall remain on at all times, unless otherwise noted
- Lighting fixtures and ballasts/drivers shall be selected and installed to ensure ease of access for servicing and ease of maintenance
- All light fixtures shall be LED with the following criteria:
 - CRI (Colour Rendering Index) to be a minimum of 80 unless otherwise noted
 - Colour temperature to be 4000K unless otherwise noted
 - Exterior luminaires to have CSA or CUL Wet Location labels
- Use light fixtures equipped with industry standard LED light engines that are equal or better in performance and build quality to Bridgelux or Xecato or equivalent

- Specify light fixtures that limit glare and uplight, and support dark sky policy
- The light fixtures shall come with a lens over the LEDs to allow for easy cleaning.
- Specify light fixtures that are locally distributed and serviced
- Lighting fixtures to have a minimum 5-year warranty
- Negotiate longer warranties where option is offered by the manufacturer
- Where accessible by the public, light fixtures are to have vandal resistant features
- The underside of ceiling mounted fixtures is to be a minimum of 2750mm above the finished floor
- Glare: Adjacent properties shall be shielded from glare or light trespass. There shall be no interference with railroad signal or operations systems due to glare. The discomfort Glare Rating shall have a Visual Comfort Probability (VCP) of 65% or greater for interior lighting. Station attendants and passengers at service counters shall be able to see each other 100% when the sliding glass panel is in the closed position. Luminaries in this location shall have parabolic egg crate lenses, with all illumination directed vertically down to the task. Passengers and station attendants shall be capable of seeing out to the exterior at night. All glass shall be clear and not tinted, for maximum visibility of the interior. Luminaries' placement shall take into account viewing angles and fields of view of close circuit television cameras. Luminaries shall not present a source of glare to surveillance cameras.
- Exit lights shall be of the fully self-contained and low energy LED type. LED replacement bulb-style is permitted.
- Emergency lighting shall be in accordance with the OBC, the Ontario Electrical Safety Code, and the latest CSA standards
- Daylight–Particular attention shall be directed to parking structure, rail station and bus terminal entrance/ exit areas, especially on large projects. Illumination shall provide for a visually comfortable transition from outdoors to facility entry areas during all hours of system operation. Illumination levels will likely have to be graduated during the daylight hours to minimize otherwise abrupt changes from outdoors to indoors, and vice versa. Photoelectric cells for the automatic operation of additional lighting fixtures may be utilized
- Sundry: All rail platform poles shall be hinged to avoid flagman services. Hinged poles shall be installed in such a manner to avoid obstructions when lowered. Hinging shall be always parallel to the track. CCTV camera(s) shall have dedicated split pole(s). PA speakers can be installed on existing lighting poles only if they are split. High-mast lighting poles shall have no objects attached onto (e.g. parking identification, PA speakers, etc.) to avoid obstruction of the lowering device
- Standard Light Pole Drawings: Digital drawing files are available for 3 and 6 metre hinged pole, 6 metre, 12 metre and 30 meter (high mast) pole under PMPS GO Standard Drawings
- Uniformity Ratio:
 - Maximum to minimum: 4:1 or better
 - Average to minimum: 3:1 or better
- Where lighting is of a complex or unique nature or if required by GO, the Consultant shall engage the services of a qualified Illumination Designer
- Design photometric digital file in PDF or DWG format, complete with printouts using recognized computer lighting design software, shall be provided for GO review of design illumination

levels. These photometric files shall be included in the As-built drawings

7.2.26 Lighting Design Requirements

Pole design shall adhere to the Metrolinx standard lighting drawing for poles (3, 6, 12 and 30 meter) unless instructed otherwise by Metrolinx

7.2.26.1 Bus Loops:

- General illumination for bus platform shall be provided by a line of full cut-off single-headed downlights on lampposts aligned with the back of bus shelters
- Lamppost height shall be kept to a minimum, based on site layout and context



Figure 26: Lighting Design Requirements - Bus Loops

- Lighting of the bus shelter, while not within the scope of site lighting, shall be taken into consideration in calculations and overall balance of lighting design
- Supplementary lighting can be integrated with the digital information signage at the front of the bus bay.
- Minimum average maintained illumination levels shall be:
 - Bus Platform Boarding Area: 100 lux horizontal and 50 lux vertical
 - Bus Platform: 50 lux horizontal, 25 lux vertical
- Colour temperature shall be 4000K and shall be confirmed through testing with site materials.

7.2.26.2 Parking Garage:

- The lighting in the parking area of the garage shall be provided by direct/indirect fixtures positioned above the bottom edge of structural beams
- The lighting in the elevator lobby shall be provided by graphic direct LED fixtures positioned parallel to the elevator doors
- In cases where the design and layout of the garage permit, use graphic direct LED fixtures to highlight key pedestrian areas and promote wayfinding within the garage
- Minimum average maintained illumination levels shall be:

- General Parking and Pedestrian Areas: 55 lux horizontal
- Ramps and Corners: 110 lux horizontal
- Elevator Lobbies: 200 lux horizontal
- Parking Garage Entrance Areas–Nighttime: 110 lux horizontal, 55 lux vertical
- Parking Garage Entrance Areas–Daytime: 550 lux horizontal, 275 lux vertical
- Colour temperature–4000K minimum
- CRI–80 minimum

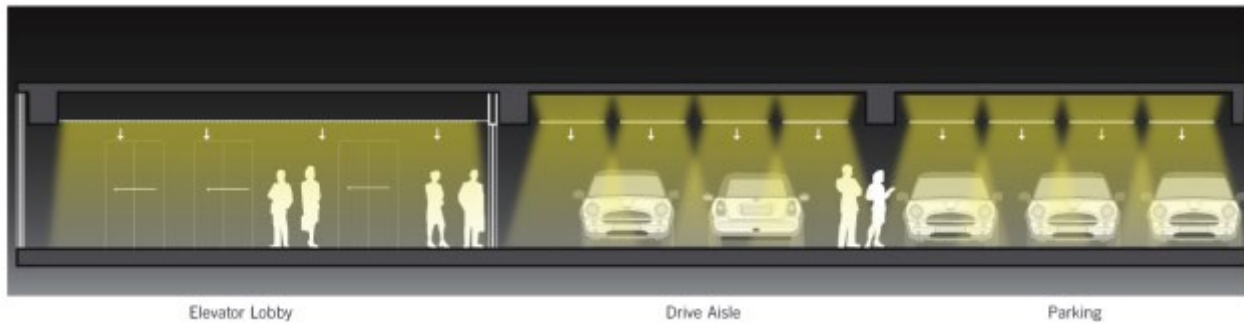

Figure 27: Lighting Design Requirements - Parking Garage

7.2.26.3 Surface Parking:

- The lighting in the parking and drive aisle areas shall be provided by full cut-off single and double-headed downlights on lampposts
- Lamppost height shall be kept to a minimum, based on site layout and context
- Maximum height of pole for luminaire shall be 30m.
- Minimum average maintained illumination levels shall be:
- Parking Lot: Refer to Table F-9
- Pedestrian Walkways: 20 lux horizontal
- Colour temperature–4000K CRI–80 minimum



Figure 28: Lighting Design Requirements - Surface Parking

7.2.26.4 Rail Platforms:

- The lighting of the platform area and its stair and elevator access points shall be provided by direct/indirect lighting fixtures that produce a graphic effect, aligned parallel to the platform edge
- At platforms without roof soffits, lighting is to be provided by direct full cut-off lighting
The platform shall be uniformly illuminated
- Lamp post height shall be 6m pole , based on site layout and on a raised base above grade
- Stairwells shall have lighting which is easily accessible for maintenance.
- There shall be step lighting as well as general overhead lighting provided.
- Avoid placing lights in the ceiling above stairs
- Minimum average maintained illumination levels shall be:
- Platform Boarding Area: 100 lux horizontal, 50 lux vertical
- Platform: 50 lux horizontal, 25 lux vertical
- Stairwells: 200 lux horizontal
- Colour temperature shall be 4000K

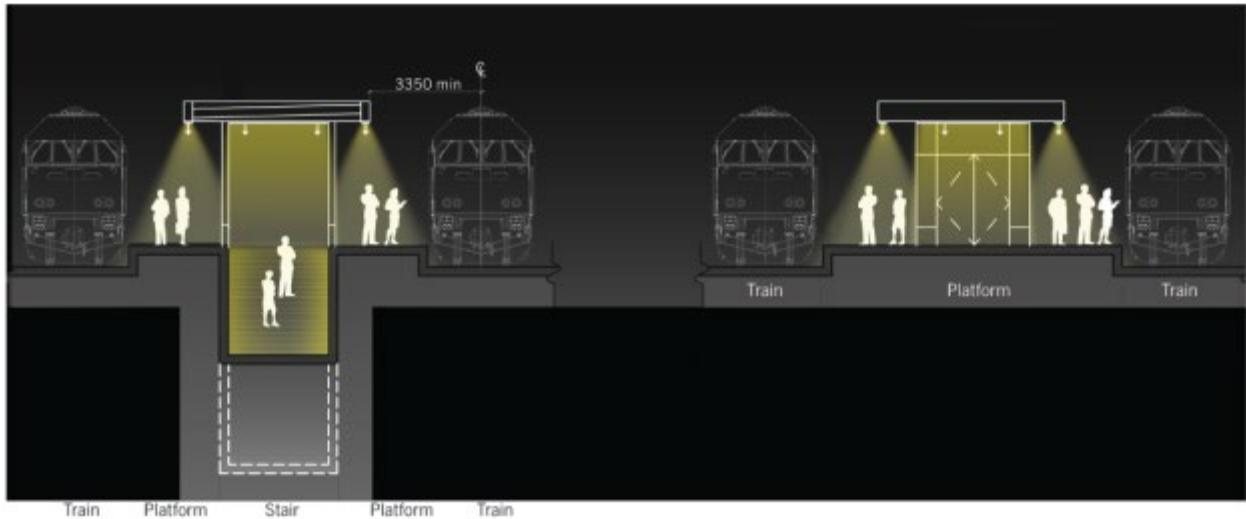

Figure 29: Lighting Design Requirements - Rail Platform

7.2.26.5 Station Plaza:

- Lighting along the Plaza Edge/Drop Off and Pick-up Area shall be provided by full cut-off double-headed downlights on lampposts aligned parallel to edge of plaza
- One head will provide roadway lighting, the other head will provide pedestrian scale lighting on the plaza
- Lamppost height shall be kept to a minimum, based on site layout and context
- Lighting of the station building shall be taken into consideration in calculations and overall balance of lighting design
- Minimum average maintained illumination levels shall be:
- Plaza Edge/Drop Off and Pick-up Area: 50 lux horizontal, 25 lux vertical
- Lighting within the plaza shall be provided by indirect light lampposts aligned parallel to the station building and integrated with the planting zone if one exists
- Plaza: 50 lux horizontal
- Colour temperature shall be:
- Plaza Edge/Drop Off and Pick-up Area: 4000K

7.2.26.6 Bridges:

- Enclosed bridges shall have ceiling integrated direct/indirect lighting that produces a graphic effect
- Open bridges shall have lighting integrated on the interior, into side elements such as structure, handrails and guards
- Light sources shall not to be visible from the point of view of train conductors
- Enclosed stairs to bridges shall have lighting integrated into side walls above head height, and lighting integrated into handrails

- Open stairs to bridges shall have lighting integrated into walls or handrails
- railing lights shall not be integral with handrail requiring replacement of handrail on light failure.
- Minimum average maintained illumination levels shall be:
- Enclosed and Open Bridges: 150 lux horizontal, 75 lux horizontal
- Enclosed and Open Stairs: 200 lux horizontal
- Colour temperature shall be 4000K

7.2.27 Lighting Control Design Criteria

For additional information on lighting control, refer to Metrolinx Standard Lighting and Controls Specification 26 50 00

7.2.27.1 Early Morning Period

7.2.27.1.1 Interior Controls:

One half (1/2) hour before the first AM train and/or bus:

- Station Building and/or Bus Terminal lighting to be 100% ON excluding ancillary area
- Tunnel and Bridge lighting shall be 100% ON
- Parking structure lights to be 100% ON

Switches and occupancy sensors shall be provided in driver washrooms, maintenance rooms, mechanical, electrical, and communications rooms, staff service and back-of-house area.

All areas with more than two fixtures shall have multiple circuits and switches. The area cannot go dark if there is maintenance or failure of a circuit.

Tunnel lighting shall be on occupancy sensors. When no motion is detected, the lights shall dim to maximum 50% output (not less). Once motion is detected, lighting shall turn on to 100%.

Bridges shall be connected to daylight harvesting photocells to save on energy when there is sufficient daylight entering the bridge.

Parking structure lights to turn OFF with the aid of photocells where light levels are high enough from daylight harvesting.

7.2.27.1.2 Exterior Controls:

One half (1/2) hour before the first AM train and/or bus:

- Platform, platform canopy, platform shelter, information signs and shelters, and building canopy lighting to be 100% ON
- Bus loop and bus loop shelter lighting to be 100% ON
- Parking lot lighting shall be 100% ON

7.2.27.2 Evening Period

7.2.27.2.1 Interior Controls:

One (1) hour after the last PM train and/or bus:

- Station Building and/or Bus Terminal lighting to drop to 30% illumination

- Tunnel lighting to drop to 50% illumination
- Parking structure lighting to drop to security lighting (i.e. 30% or better)
- Occupancy sensors shall be provided on Station Building and/or Bus Terminal lighting controls
- Tunnel lighting shall be on occupancy sensors. When no motion is detected, the lights shall drop 50% output, as noted above. Once motion is detected, lighting shall turn on to 100%
- Occupancy sensors shall be provided on Parking Structure lighting controls

7.2.27.2.2 Exterior Controls:

One (1) hour after the last PM train and/or Bus:

- Platform, platform canopy, platform shelter, information signs and shelters, and building canopy lighting to be 100% OFF
- Building canopy security lighting (i.e. 30% or better, as determined by Station Services) to remain on
- Parking lot lighting to drop to security lighting (i.e. 30% or better, as determined by Station Services)
- Illuminated Station ID sign to turn OFF
- Bus loop and bus loop shelter lighting to be 100% OFF

Lighting control is to be incorporated into a BAS when required.

7.2.27.3 Exterior Lighting On/Off Controls

The lighting controls shall be designed to provide the following functions:

- The lighting controller (i.e. timer) shall be programmable controlled, PLC, complete with automatic daylight savings adjustment
- Provide a photocell control on all control designs where the default is “dusk to dawn”
- Sites that are being rehabilitated shall have their lighting controls modified to meet these requirements
- Wireless lighting control shall be permitted
- Exterior override lighting control shall be added as well for wireless systems.

7.2.27.4 Dimmable Illumination

- Photocells, motion and occupancy sensors are to be used within multi-level parking structures, tunnels and pedestrian bridges
- Occupancy sensors are to be placed to allow no blind spots
- Refer to Illumination Levels section for minimum lighting levels within multi-level parking structures, tunnels and pedestrian bridges as recommended by IESNA
- The lighting control shall be flexible i.e. programmable controlled per circuit complete with IP addressable and remote access and control
- Methods of reducing energy usage and maintenance shall be considered in design. LED Lighting shall be continuous dimmable (0 to 10 V DC). The design shall consider occupied and a 50 % reduction in light levels when unoccupied. Light harvesting systems shall also be considered

7.2.27.5 Override Switches

Station lighting is to be wired into separate zones listed in the table and controlled independently by one of three master override switches.

- Switches shall be strategically located at the following 3 locations within:
- Service Counter area
- Electrical Room
- Exterior of the station
- Switches shall be labeled and housed in a weather tight, PVC lockable box accessible to GO staff, and GO approved contractors/agents
- Remote parking shall have its own override switches following the same requirements as above.
- The locations shall be inside the local power cabinet and outside the cabinet housed in a weather tight, PVC lockable box
- Overall Master Shut Off overrides programmed lighting controls for a prescribed timeframe. When prescribed time frame elapses, programmed lighting resumes

7.2.27.5.1 Zones for Override Switches

- Station building
- Surface parking
- Multi-level parking
- Bus loop
- Rail Platform
- PUDO
- Access Road
- Overall Master turn on or shut off

7.2.28 Illumination Levels

- The lighting control shall be flexible i.e. programmable controlled per circuit complete with IP addressable and remote access and control
- The design shall consider methods of reducing energy usage and maintenance. LED Lighting shall be continuous dimmable (0 to 10 V DC)
- The design shall consider occupied and a 50% reduction in light levels when unoccupied. Light harvesting systems shall also be considered
- The system shall be controlled by a Programmable Logic Controller which can handle multiple lighting levels and areas complete with unique on and off, a remote override, and a changeable daylight savings time
- The changes to the on and off configurations shall be done either remote or local computer connections
- Service areas like electrical rooms are to have ceiling mounted occupancy sensors on all light switches

- Exterior decorative, illuminated signage and perimeter lighting shall be all part of the design
- Pole lighting shall be to GO Standards for referenced in the DRM
- Reduction of light pollution of flood lights and wall washers (spill off into surrounding canopies) is to be considered
- Station locations with a high probability of vandalism shall have extra bright illumination, if required and viable in terms of adjacent neighbourhoods
- Photocells and occupancy sensors are to be used

The lighting levels for inside a covered Parking Facility shall be to a minimum recommended by IESNA and as follows:

7.2.28.1 Illumination Levels

Table 45: Illumination Levels

Location	Working Plane Height
<i>Circulation Areas both public and non-public including exterior traffic areas</i>	<i>Floor level</i>
Public Seating (waiting areas)	850mm
Workshops	850mm
Vertical illumination (task lighting)	At the task

7.2.28.2 Interior Lighting Illumination Levels

Table 46: Interior Lighting Illumination Levels

Location	Illumination Level
Waiting Room	20 Fc (200 LUX)
Station Attendant Room	20 Fc (200 LUX)
Service Counter task lighting	40 Fc (400 LUX)
Staff Washroom	20 Fc (200 LUX)
Public Washroom	20 Fc (200 LUX)
Electrical Room	75 Fc (750 LUX)

Communications Room	75 Fc (750 LUX)
Maintenance/Storage Room	20 Fc (200 LUX)
Elevator/Escalator (incl. elevator vestibules)	20 Fc (200 LUX) (Note 1)
Shelter	5 Fc (50 LUX) (Note 2)
BRT Building (Bus Rapid Transit)	15 Fc (150 LUX)
Shop/Workbenches	30 Fc (300 LUX)
Electronic Shop Workbenches (task lights)	As per IES
Garage	30 Fc (300 LUX)
Mechanical Room	75 Fc (750 LUX)
Dispatch Room	15 Fc (150 LUX)
Hallway/Corridor/Tunnel/Stairwell	20 Fc (200 LUX)
Office	As per IES or CNIB
Other	As per IES or as directed by GO or CNIB

Minimum average maintained illumination levels as per IES / CNIB or as directed by GO:

Note 1: Elevator Code to govern

Note 2: Low illumination level to equalize visibility of the platform

7.2.28.3 Exterior Lighting Illumination Levels

Table 47: Exterior Lighting Illumination Levels

Location	Illumination Level
Parking Lot	3 Fc (30 LUX)
<i>Parking Structures</i>	
General Parking and Pedestrian Areas Occupied	5 Fc (55 LUX)
Unoccupied Areas	2.5 Fc (28 LUX)
Ramps and Corners	10 Fc (110 LUX)
Entrance Areas	50 Fc (540 LUX)

Passenger Drop-off & Pick-up Areas	5 Fc (50 LUX)
Train Platform	5 Fc (50 LUX)
Mini-Platform/Designated Waiting Area	15 Fc (150 LUX)
Access Road	2 Fc (20 LUX)
Bus Platform	5 Fc (50 LUX)
Platform Boarding Area (bus and train)	10 Fc (100 LUX)
Canopy Separate from Buildings	20 Fc (200 LUX)
Canopy Walkways at Buildings	10 Fc (100 LUX)
Canopy at Platform	5 Fc (50 LUX)
Canopy at Mini Platform	15 Fc (150 LUX)
Canopy at Station	10 Fc (100 LUX)
Platform Union Station and UP Express	20 Fc (200 LUX)
Canopy at Boarding Edge	10 Fc (100 LUX)
Bridges, Tunnel or Overpass & Open Stairwell at a Building	20 Fc (200 LUX)
Exterior Stairs & Walkways Separate from Buildings	20 Fc (200 LUX)
Pedestrian Paths and Bike Ways	2 Fc (20 LUX)
Layover General Lighting	2 Fc (20 LUX)
Wayside cabinet and Switch Area	5 Fc (50 LUX)
Pedestrian Bridges	20 Fc (200 LUX)

Minimum average maintained illumination levels as per IES / CNIB or as directed by GO

7.2.28.4 Lighting Levels for Inside a Covered Parking Facility

Table 48: Lighting Levels for Inside a Covered Parking Facility

Area	Specification	Colour Temperature
General Parking and	5 Fc (50 LUX)	4000 K

Pedestrian Areas		
Ramps and Corners	10 Fc (110 LUX)	4000 K
Entrance Areas	50 Fc (540 LUX)	4000 K
Service Rooms	50 Fc (540 LUX)	4000 K
Stairways and Elevator Lobbies	20 Fc (200 LUX)	4000 K

7.2.29 Light Sources and Controls

7.2.29.1 Interior Lighting Sources and Controls

Table 49: Interior Lighting Sources and Controls

Location	Light Source	Control and Backup
Platform Access (Tunnels and Bridges)	LE-1, LE-2	Time of day controller, 100% station open hours, 50% minimum station closed with occupancy sensors. Daylight harvesting where possible. Occupancy sensor overrides all.
Waiting	LE-3, LE-4, LE-5	Time-of-day controller, 100% station open hours, 10% minimum station closed, 10% on Generator. Day light harvesting were possible.
Station Attendant	LE-3, LE-4, LE-6, LE-7, LE-8, LE-10	Local switches. One fixture UPS + Generator backed-up over service counter, one over cash area and safe, or 10% minimum station closed
Staff Washroom	LE-11	Occupancy sensor switch. One luminaire on UPS + Generator
Public Washroom	LE-12, LE-13	On/Off switch with occupancy sensor, one fixture on UPS + Generator
Electrical, Comms, Mechanical, Maintenance/Janitor, and Storage Rooms.	LE-15	On/Off switch with occupancy sensor, 50% on UPS + Generator in Mechanical, Electrical and Comms. Rooms only
Shop	Linear LED 2438 mm long, suspended. Task lights	Local switching or to suit particular application, 10% on UPS + Generator

	over equipment and work-benches to suit functions	
Garage Maintenance Shop	LED for shops. LED Task lights where required	Panel or central switching to suit particular application. 10% on UPS + Generator or to Code requirements
Dispatch	LED, and supplementary illumination for maintenance with task lights to suit	Local switches, dimmers, 10% on UPS + Generator.
Vestibule and Other Miscellaneous Areas	LE-14	Time-of-day controller, 100% station open hours, 10% minimum station closed, 10% on Generator. Day light harvesting where possible
Office	Per IES	10% on UPS + Generator

7.2.29.2 Exterior Lighting Sources and Controls

Table 50: Exterior Lighting Sources and Controls

Location	Light Source	Control and Backup
Parking Lot Passenger Drop-off and Pick-up Areas Bus Loop Bus Platforms	LED area lights or down lights on 6 or 12 m high galvanized steel poles or 30m high masts (use of LED on 30m high masts approved by GO Transit on a case-by-case basis).	Circuited and dimmed for 30% in operation during station closed hours (photo-control only) and to have manual override of the photo control and time-clock (the manual override shall not be digital) on generator
Access Roads	LED area lights or down lights on 6 or 12 m high galvanized steel poles or 30m high masts (use of LED on 30m high masts approved by GO Transit on a case-by-case basis).	Circuited for 30% in operation during station closed hours (photo-control only) and to have manual override of the photo control and time-clock (the manual override shall not be digital)
Parking Structure	LED	Day light harvesting and occupancy sensor control of two light levels and timer on generator

Rail Platform	LED on 6 m hinged poles on 300 mm high concrete bases or in canopy.	Both timer and photocell controlled, on Generator. During station closed hours 100% off. Override switch (snow removal use): 100% on
Mini-Platform	Same as Rail Platform	Controlled as part of Rail Platform
Tunnel, Enclosed Bridges and Canopies	LED, 1219 mm long, c/w vandal resistant lenses, lights shall be dimmable, when space not occupied. Allow for at least 2 circuits, alternate circuits every other pole	Lighting control, 50% on UPS + Generator
Internal Stairwell (tunnel, parking structure)	LED luminaries, semi-recessed in walls, below handrails	Lighting control, 30% on UPS + Generator
Exterior Stair and Walkway	Same as parking lot, Pole location to suit	Same as parking lot

All lighting controls shall be fully documented and turned over at the commissioning phase. Consultant shall examine the different alternatives of parking lot illumination design: high mast, flood lighting, and area lighting. Generally, stations near residential areas shall have area lighting. (Flood lighting shall be avoided where ever possible). Where floodlighting is used, upward glare shall be addressed and minimized. High mast lighting shall be considered for parking lots in non-residential areas.

For ease of lighting maintenance, large areas (tunnel, bride, waiting area, boardrooms, lunchrooms, maintenance facilities, etc.) lighting shall have at least two lighting circuits.

7.2.30 LED Lighting Requirements

- LED light fixtures shall be warranted for a minimum of five years
- LED light fixtures shall work with the available power supply on site
- Every fixture shall have surge suppression
- Fixtures shall be provided with a lighting facts label
- Outdoor fixtures must have an IP65 general use rating. For locations subject to high pressure washing (tunnels, platforms, or parking structures) the fixtures shall have an IP66 rating
- The lighting design shall be such that the specified minimum lighting levels shall be maintained for a minimum of 15 years
- Fixtures' lighting efficiency shall equal the most current industry accepted standard
- The lighting efficiency shall not be achieved by overdriving the LEDs
- The LEDs in the fixture must be of the same colour temperature
- LEDs with CRI below 75 are not acceptable for indoor lighting

- Colour temperature of LED light fixtures shall be uniform throughout the area (3500 K for indoors, 4000 K for outdoors)
- The fixture shall meet LM 79 rating and the chips shall meet LM 80 rating. LED B50 and L70 lifetime graph shall be provided
- The fixture must be vandal resistant and shall be modular in design for easy upgrade of the LED light engine, simple maintenance (straightforward part replacement) and installation
- The component connections shall be of plug-in type, tool-less removal and replacement
- The fixture shall be dark sky compliant, with good light control and minimum to no glare
- Lens, if required, shall be flat tempered glass, unless otherwise noted
- The fixtures shall have network connectivity option and be remotely dimmable

7.2.31 Lightning Protection, Grounding and Bonding

7.2.31.1 Grounding and Bonding

This Section outlines protective grounding and equipotential bonding requirements, based on the TN-S system arrangement, including:

- Transformer neutral grounding
- Electrical and Communications Rooms
- Exposed conductive parts of electrical equipment
- Extraneous conductive parts
- Building main ring electrode

The design of the ground system shall be based on:

- Ground resistivity data
- Ground resistance of the whole system and its components
- Ground potential rise
- High ground resistance
- Systems fault currents and their duration
- Conductor ratings

The design calculations shall show that the fault currents and DC stray currents will not damage the grounding system.

7.2.31.2 Soil and Survey Calculations

A ground resistivity survey shall be carried out at each site. The weather conditions prior to and at the time of the surveys shall be recorded in the report and an assessment made of the seasonal variations in resistivity based on meteorological data for the area.

7.2.31.3 System Requirements

Grounding system components include:

- Ground electrode

- Main grounding terminals or bars
- Grounding conductors
- Protective conductors
- Equipotential bonding conductors
- Electrically independent ground electrodes for special systems (clean ground)

Shared neutral is not allowed. Ground electrode total combined resistance value shall not exceed 5.0 ohm, during any season of the year and before interconnection to other grounded systems or grounding means.

Protective conductors shall not be formed by conduit, trunking or ducting. Ground Fault Loop Impedance for complete circuits shall be recorded. Supplementary Equipotential Bonding: Connect all extraneous conductive parts of the buildings such as metallic conduit and raceways, cable trays and cable armour to nearest grounding terminals by equipotential bonding conductors.

A Ground Inspection Chamber shall be provided for each ground rod where connected to a grounding conductor and shall extend 150 mm below top of ground rod.

7.2.31.4 Transformer Grounding

Transformer body grounding terminal shall be connected to MV main grounding bar by insulated copper grounding conductor not less than 3 AWG per 100 kVA of transformer rating, with a minimum of 2 AWG.

Transformer neutral (star point) shall be connected by insulated grounding conductor (colour White) directly to independent grounding electrode. Neutral grounding conductor shall be sized for maximum ground fault current for 5 seconds.

7.2.31.5 Grounding of Distribution Boards, Lighting Installations and Wiring Accessories

Distribution, lighting and power panel boards shall be connected by separate insulated protective conductors run together with incoming feeder cable, connecting ground terminals in panel boards with respective main distribution board grounding bar.

Final Ring Sub-circuits: Protective conductor of every final ring sub-circuit shall be in the form of a ring having both ends connected to ground terminal at origin of circuit in panel board.

Lighting fixtures and other exposed conductive parts of electrical installations, such as switches, heaters, air conditioning units, etc. shall be connected by protective ground conductors to grounding terminals of their respective panel boards.

7.2.31.6 Grounding of Electrical and Communications Rooms, and Fixed Machinery

A common 50 mm wide x 6 mm thick grounding copper bus shall be connected to the door frame and encircle the Electrical Room and Communications Room.

Motor and other equipment ground terminals shall be connected also by protective ground conductors of each branch circuit to ground terminal/bar at motor control centre, panel, or distribution unit.

Conductors shall be securely fixed, recessed in floor grooves or niches, or fixed to walls by appropriate staples. Ground bar or loop shall be securely fixed to building wall with copper or brass saddles.

7.2.31.7 Grounding of Road/Parking Lot Lighting Poles

All circuits require dedicated ground wires.

Every other pole shall have a dedicated grounding rod.

Any metal surfaces associated with handwells and manholes, including non-conductive metal surfaces, must be grounded.

Every second pole shall be grounded with a minimum of one ground rod complete with inspection chamber.

7.2.31.8 Grounding of Signal and Communication Systems

For telephone, alarm, voice and data, and other communication systems, provide a clean system to each service location, terminal cabinet, wiring closet, and central equipment location. Terminal Cabinets: Terminate grounding conductor on cabinet grounding terminal.

7.2.31.9 Clean Ground

In general, clean ground grounding system shall be provided for data system, telephony and other communication systems, and:

- Shall be single point ground to main electrical system ground
- Grounding cables shall not be run parallel with other grounding cables or power cab

7.2.31.10 Grounding of Fences

Metallic fences within 1.8 m of any equipment or structure above the surface of the ground, which is connected to the main grounding system, shall be bonded to the grounding system.

Ground rods shall be driven adjacent to the posts inside the fence line to a depth of not less than 3.0 m. Where no metallic posts are provided, the ground rods shall be connected directly to the metal wires, mesh, or other components of the fence.

7.2.31.11 High Resistance Grounding Systems

The high resistance grounding system shall limit the ground fault through the transformer neutral. The equipment will be located indoors in a climate-controlled building. The resistor shall be stainless steel edge wound type. The resistor shall be provided with taps for the adjustment of ground current magnitude in several steps.

Meter relay with auxiliary contacts shall sense voltage across the grounding resistor and initiate remote annunciation of a ground fault condition. The resistor to include appropriate taps to limits the ground current flow between 0.9 to 5.0 Amperes for 600V.

7.2.31.12 Service, Communications and Hub Room Grounding

The Communications rooms and Hub rooms shall form a Dedicated Ground Zone (DGZ). All communications equipment in the Communications and Hub Room shall be electrically insulated from the building structure. A single point grounding method shall be employed in grounding the communications equipment. The access doorframe and door to the communication room shall be grounded using the same grounding method and loop as the Communications and Hub Room.

7.2.32 Lightning Protection

Lightning protection system is designed to protect structures from damage due to lightning strikes by intercepting such strikes and safely passing their extremely high voltage and current to "ground." Such system shall be installed were there are no surrounding structures that would provide a cone of protection.

- Lightning protection systems shall include a network of lightning rods, metal conductor, and ground electrodes, designed to provide a low resistant path to ground for potential strikes.

7.2.33 Identification

Label and identify all wiring, equipment, instruments, control and electrical devices etc. to indicate duty, nomenclature identification number, service/function, to the satisfaction of GO. Identifications shall be in English. Alternative methods of labelling may be submitted for approval.

For information on Identification and nomenclature to be used refer to Metrolinx Electrical Identification and Nomenclature Specification 26 05 53

7.3 Communications

Communications design is meant to be a proactive, preventive approach to security through the identification and development of strategies that minimize potential threats and vulnerability to employees and customers, protects company assets from theft, abuse, and vandalism, and reduces unnecessary damage or waste.

The level of design and installation at each station, facility, or wayside layover will depend upon the unique conditions of each site and in accordance with GO Metrolinx corporate policy. Monitoring and recording requirements will be determined by the stakeholders.

This Section outlines the design requirements for Communications of GO Transit fixed facilities in terms of the following subjects:

- Close Circuit Television (CCTV)
- Public Address System (PA)
- Information Technology (IT)
- Telephone Network
- Security System
- Fare Handling Systems
- Service Counter Talk Thru Systems
- Building Automation Systems
- Radio

7.3.1 Closed Circuit Television (CCTV)

Closed Circuit Television (CCTV) systems provide a method to remotely monitor and assess areas identified either as secure, public, or controlled access. GO utilizes Closed Circuit Television systems at stations, terminals, and other locations to monitor train, bus arrivals, and departures, observe customer flow, and to conduct surveillance related to the protection of its corporate assets.

The level of CCTV system design and installation at each station or facility depends upon the unique conditions of each site and in accordance with GO corporate needs. Monitoring and recording requirements are determined by the stakeholders.

All the CCTV cameras at various GO locations can be viewed by the following user groups:

- Rail Operations and Bus Operations

- Station Services
- GO Transit Safety

The CCTV systems are divided into two significant groups, Operational systems, and Security Systems.

Coordination with Lighting and Signage System installation:

- For new facilities, Lighting and Video Systems shall be designed concurrently
- For existing facility that already have lighting, the Video System must be designed to work with the existing lighting or upgrades may be needed for the existing lighting, privacy concerns of viewing and recording video images, work rule concerns of viewing and recording video images, and/or legal implications of video surveillance

The corporate standard system for archiving recorded video must be used. This includes, but it is not limited to, the following factors:

- Legal requirements
- Secure and controlled storage area

Design Plans shall comprise of:

- CCTV Block Diagram, line and riser diagrams
- CCTV coverage zones and locations
- Power support for systems, including Emergency and UPS power
- Communication support for systems
- Temperature control for systems

7.3.1.1 Operational system

This system supplies operational assistance to various GO Transit departments by providing and recording real time images.

7.3.1.2 Security system

This system also provides and records images in real time, and it is used to deter the entry of unauthorized personnel, and provide record for System Safety investigations. The video information derived from the cameras of the Operational and Security systems are recorded on local servers. The CCTV system records on a 72-hour cycle.

7.3.1.3 Local Monitoring

All cameras, including pan/tilt/zoom (PTZ) at each site are viewed locally on a dedicated video monitor and manipulated by means of a keyboard, mouse, and/or joystick.

7.3.1.4 Remote Monitoring

The systems are connected via GO Transit network, which allows remote and local access to all cameras on all systems. The current method of transmission of video images is operating on MPLS circuits and Metrolinx

IT WAN Infrastructure. Various CCTV system viewing and monitoring rights are granted through administrative privileges as set out by GO System Safety.

7.3.1.5 CCTV Head End System

Refer the IT Station Telecommunications and Electronic Systems document for detailed specifications.

7.3.1.6 Components

The equipment required for either the Operational or the Security CCTV system generally includes, but is not limited to the following:

- Colour Monitors—24” or 32” display monitor inside station service area, 32” or 50” at Transit Safety Dispatch, wall or ceiling mounted each site is dependent on local requirements and conditions
- This will include all hardware required for the installation
- Outdoor grade platform monitors to assist CSA to ensure doorways are clear of passengers
- Typically used on curved platforms with obscured vision and installed on mini-platform on dedicated pole
- Cameras—Fixed or Pan/Tilt/Zoom, high sensitivity (0.08fc) and other new technology compatible and approved with the corporate standard system
- Camera Housings—weatherproof (outdoor), moisture and dust-proof, maintain the ambient temperature within the housing in the camera operating temperature range of –10°C to +50°C
- A sunscreen is fitted to protect the camera from direct sunlight
- Indoor housings are either high impact polycarbonate or epoxy coated steel, dust-proof, with top mount assembly, suitable for cameras with fixed focal length
- Lenses—Fixed with auto-Iris. Aspherical lenses are used on platforms to suit lighting conditions

7.3.1.7 Design/Installation Criteria

CCTV system implementation is part of the overall facility design. The level of design and installation at each station, facility, or wayside layover will depend upon the unique conditions of each site and in accordance with GO corporate needs. Monitoring and recording requirements will be determined by the user groups.

7.3.1.8 Data and Power Transmission

Must be included in the overall system wiring and power design, and includes the following:

7.3.1.8.1 Cable Systems (wire and fiber optic)

- Twisted Pair
- Coaxial Cable
- Fiber Optic—preferred medium of data transmission

7.3.1.8.2 Transmission Architecture

- Network

7.3.1.8.3 Transmission Distance

- Repeaters
- Signal Boosters

- Equalization

7.3.1.8.4 Environmental

- Temperature extremes (high and low)
- Weather (rain, snow, icing, flooding, etc.)
- Physical (topographic conditions)
- Lightning and Transients (electrical grounding)

7.3.1.9 Installation: CCTV Cabling

All cables shall be run in a neat and orderly fashion in a conduit system.

CCTV cables shall be designated at both ends as per design requirements provided in Section 0: Electrical.

All cables that run from cameras to terminating equipment shall be single length (splices in these cables are not allowed)

Sufficient slack (minimum 1.0 m) shall be left in case it is necessary to re-terminate the cable.

Emergency power—all systems and components shall be powered via a single source from the emergency power panel within the communication room.

7.3.1.10 Conduits

Conduits shall be designated with “CCTV” at terminating ends.

Wiring shall be run in conduit. Outdoor cable shall be run in epoxy coated rigid galvanized steel; indoor cable may be R.G.S. or E.M.T. depending on the location.

All underground conduits shall be rigid PVC.

Conduit breaks prior to entry in to a building shall be incorporated in the design. For detailed design, requirements refer to Section 0: Electrical

7.3.1.11 Connections

All copper connections shall be copper-to-copper compression type with insulating covers.

Poles with cameras shall have one-meter slack cable in raceway.

Fish cord in all CCTV raceways shall be installed for future use.

Splices are not allowed.

7.3.1.12 Hand Wells

Dedicated hand wells, located away from doors and main traffic areas, shall be provided for CCTV, separate from power.

Where installed in public areas, all enclosures, cover-plates, outlet plates, access panels, and hand wells shall be provided with keyed temper-proof hardware.

Drainage shall be considered for all hand wells.

7.3.1.13 CCTV Camera Placement

Placement shall include the following considerations:

- Mount cameras at 6 m height to prevent damage and provide good field of view
- 6 m dedicated poles are to be used for normal mounting
- If higher installation is required, firm mounting masts shall be used to prevent motion
- Utilize and include existing physical characteristics and infrastructure using CPTED principles
- Civil structures—roads, building, windows, important rooms, etc. existing barriers and fencing, terrain and ground contours
- Use of lens, zoom, and terrain conditions when setting and selecting camera locations
- Be aware of rising and setting sun when setting camera alignment to avoid the flare and blinding effects on the camera
- Mount cameras inside secure areas and provide tamper protection assume all cameras are subject to tamper
- Outdoor, cold, hazardous conditions, etc. Provide appropriate camera housings for worst-case environmental conditions
- Existing lighting; existing power; existing data and communication networks
- Existing environmental controls
- Impact considerations on neighbouring properties
- At a minimum, an illumination of 2 foot-candles throughout assessment area shall be maintained

Table CCTV Coverage Type (Image Quality) provides image resolution for CCTV Camera Placement Tables below 47 thru 51.

Table 51: CCTV Coverage Type (Image Quality)

Requirement	Pixels / Meter
Identification	250
Recognition	125
Monitor	75

Table 52: CCTV Camera Placement - Parking

Parking Lots – At GO Stations				
Area	Fixed	PTZ	Coverage Type (Image Quality)	Comment
Entrances To Specific Lots	X		Identify	Identify driver and plate
Exits from Specific Lots	X		Identify	Read plate, monitor traffic flow

General Area Coverage	X		Monitor	Provide coverage, aid in investigation, customer security, deter crime. General coverage shall be provided through the use of multiple strategically placed cameras on dedicated poles for each lot area. The goal is to achieve 100% coverage if possible.
Main Entry drive Feeding to Multiple Lots	X		Identify	Capture plate number, driver identification, monitor traffic flow.
Main Exit Leaving	X		Identify	Read plate, monitor traffic flow, aid in investigations
Immediate Area		X	Monitor	Pan Tilt Zoom (PTZ) cameras within or adjacent to lot in order to facilitate operational needs / safety inquiries / security investigations / incident response / etc. Positioning shall be in a manner that a PTZ camera is able to zoom in and view any immediate area. Multiple strategically located PTZ cameras through the parking lot perimeter areas shall be coordinated to allow viewing of all parking lots for the entire station during investigation only. PTZ cameras shall not be considered as part of the typical coverage areas under surveillance.
Parking Lots - At GO Facilities - Park and Ride				
Entrances To Specific Lots	X		Identify	Identify driver and plate
Exits from Specific Lots	X		Identify	Read plate, monitor traffic flow
General Area Coverage	X	X	Monitor	Provide coverage, aid in investigation, customer security, deter crime. PTZ cameras on as-needed basis. Higher crime rates will dictate the usage of additional cameras.
Bike Shelters	X		Recognize	Monitor and recognize all who enter the shelter providing investigational information, customer reassurance
Parking Structures				
Area	Fixed	PTZ	Coverage Type (Image Quality)	Comment
Entrances To Structure	X		Identify	Identify driver and plate dedicated to entry lane.

Exits from structure	X		Identify	Read plate, monitor traffic flow. Dedicated to exit lane
General Area Coverage	X		Monitor	Provide coverage, aid in investigation, customer security, deter crime. Each drive and parking lane shall have at least one dedicated camera at each end looking in to provide a more complete coverage area.
Pedestrian Entry	X		Identify	Identify all who enter through a controlled entry point.
Pedestrian Exit	X		Identify	Identify everyone who exits through a controlled entry point.
Stairs	X		Monitor	From top looking down maximum view, use 2 cameras if U-shaped stairs. Intent is to aid in customer claims of slip and fall, decrease likelihood of vagrancy, vandalism and violence.
Stair Vestibules	X		Monitor	Coverage to promote safety and for investigational purposes.
Elevators	X		Recognize	Passenger security, investigation purposes, emergency situations, confined space monitoring. Dedicated inside elevator viewing maximum area with emphasis on the emergency call button.
Elevator Vestibules	X		Monitor	Dedicated to view vestibule outside elevator, viewing 2-way call for assistance button and ability to view maximum area inside the elevator. When multiple elevators exist side by side it may be necessary to share coverage with 2 cameras
Elevator Lobby/Waiting Area	X		Monitor	Dedicated to view vestibule outside elevator, viewing 2-way call for assistance button and ability to view entire waiting area. If required, more than 1 camera shall be used to achieve as close to 100% coverage as possible.
Service Rooms	X		Monitor	Monitor door - can share camera with other service rooms if sharing a common entry area.
Perimeter	X	X	Monitor	Strategically place fixed cameras on each side monitoring entire exterior perimeter walls. One PTZ to monitor and investigate on each side of perimeter.
2 Way Call devices	X		Recognize	Each 2 way call device shall have a dedicated fixed camera monitoring the device.
General NOTE: 1		X	Monitor	Each parking level drive lane shall have PTZ camera capable of viewing immediate floor level for investigation, monitoring. More than one PTZ is

				required to facilitate coverage of structures with multiple drive lanes. PTZ camera shall not be used in place of fixed monitoring
General NOTE: 2		X	Monitor	One on each exterior side of structure to monitor general area, provide live monitoring, and aid in investigation. If obstructions such as stairs are hindering view then a second camera shall be dedicated to facilitate complete coverage.

Table 53: CCTV Camera Placement – Stations Exterior and Interior

Station Exterior				
Area	Fixed	PTZ	Coverage Type (Image Quality)	Comment
Entry Points - Doors	X		Identify	Facial recognition at all entry points. Where vestibules exist, cameras shall be dedicated to identify passengers. Separate dedicated cameras shall be used to provide vestibule coverage with no hiding spots.
Waiting Areas Include DWA	X		Monitor	Waiting areas shall have dedicated coverage of entire area. If area is large multiple cameras may need to be utilized to ensure 100% coverage.
Kiss And Ride Pickup	X		Monitor	Cover entire area with fixed cameras ensuring the Bell telephone and any 2-way communication device locations are covered by fixed monitoring. Provide PTZ for investigation in area. Ability to view vehicle plates and passenger pick up and drop off points.
Pedestrian Walkways	X		Monitor	Provide coverage of entire walkway on Metrolinx property.
Bike Shelters	X		Recognize	Monitor and recognize all who enter the shelter providing investigational information, customer reassurance. Larger bike shelters may require 2 fixed cameras for best viewing.
Bike Lanes	X		Monitor	Bike lanes within Metrolinx property, end to end.
Property Perimeter	X	X	Monitor	Strategically place fixed cameras to monitor entire station and lot perimeter. One PTZ to monitor and investigate on each side of perimeter.
Laneways / driveways	X		Monitor	Coverage of all laneways allowing for continuous monitoring of vehicle movement throughout the

				property; this must provide ability to track vehicles from when they enter the property to final parking location in lot or parking structure. Entry points not covered by the parking lot cameras shall have the capability to capture license plates if specific location placement allows.
Station Interior				
Stairs / Escalator	X		Monitor	From top looking down - maximum view, if long stairs use 2 cameras.
Stair Vestibules	X		Monitor	Dedicated camera to cover vestibules not covered by stair cameras
Elevators	X		Recognize	Passenger security, investigation purposes, emergency situation, confined space monitoring. Dedicated inside elevator viewing - maximum area with emphasis on the emergency call button.
Elevator Vestibules	X		Monitor	Dedicated to view vestibule outside elevator, viewing 2-way call for assistance button and ability to view maximum area inside the elevator. When multiple elevators exist side by side it may be necessary to share coverage with 2 cameras.
Elevator Lobby/Waiting Area	X		Monitor	Dedicated to view vestibule outside elevator, viewing 2-way call for assistance button and ability to view entire waiting area. Possibly more than one camera shall be used to achieve as close to 100% as possible.
Station Lobby	X	X	Monitor	Coverage of entire lobby with fixed camera , 1 PTZ for live monitoring and investigation centrally located.
Station Entry Points (pedestrian)	X		Identify	Identify any person who <u>enters</u> through any controlled entry point (pedestrian entry points).
Station Exit Points	X		Identify	Identify everyone who <u>exits</u> through a controlled entry point.
Customer Service Desk Interior	X		Identify	Fixed dedicated camera for each service counter attendant, camera placed to view customer face over the shoulder of service attendant. Provide fixed camera dedicated to view door entry to customer service area(from inside area)
Customer Service Desk Exterior	X		Monitor	Camera shall view the side of the service counter, providing a profile view of anyone at service

				counter.
Station Vestibules	X		Monitor	Coverage of entire vestibule area. Separate from entry and exit cameras at doorways and entry points
Service Rooms	X		Monitor	Monitor door - can share camera with other service rooms if on same side of building

Table 54: CCTV Camera Placement – Rail Platforms, Tunnels, Bridges, Bus Platforms

Rail Platforms				
Area	Fixed	PTZ	Coverage Type (Image Quality)	Comment
Service Rooms	X		Monitor	Monitor door - can share camera with other service rooms if on same side of building
Stairs / Escalator	X		Monitor	From top looking down maximum view, if long stairs use 2 cameras.
Stair Vestibules	X		Monitor	Dedicated camera to cover vestibules not covered by stair cameras
Elevators	X		Recognize	Dedicated to view interior elevator, viewing 2-way emergency call for assistance button.
Elevator Vestibules	X		Monitor	Dedicated to view vestibule outside elevator, viewing 2-way call for assistance button and ability to view maximum area inside the elevator.
Elevator Lobby/Waiting Area	X		Monitor	Dedicated to view vestibule outside elevator, viewing 2-way call for assistance button and ability to view entire waiting area. Possibly more than one camera shall be used to achieve as close to 100% as possible.
Platform Ends Both - Rail operations		X		Looking down track to monitor rail traffic and switches (Operational)
Platform Ends Both - Platform Monitoring	X		Monitor	Monitoring platform, looking in towards customer waiting areas on platform.
Mini Platform	X		Identify	Coverage from both sides, capture 2-way call button.
General Platform Area	X		Monitor	Coverage with fixed cameras 100%.

Platform Shelters	X		Recognize	Interior. Dedicated fixed cameras.
Central Location		X		At opposite end of Mini Platform from 2-way call button, monitor mini platform / safety & security investigations / incident response / etc.
Customer Service Attendant (CSA) - Cameras	X		Monitor	Cameras to be deployed at all stations that have a curve on platform. The CSA while standing on the Mini Platform shall be able to view the coverage provided on the dedicated screen/s. Coverage shall also be provided for any and all pedestrian crossings on the rail corridor. These are operational cameras and shall not be considered part of the typical platform coverage provided. These are in addition to the platform coverage monitoring.
Note: 100% coverage of platforms is required.				
Tunnels				
Area	Fixed	PTZ	Coverage Type (Image Quality)	Comment
Stairs / Escalator	X		Monitor	From top looking down maximum view, use 2 cameras if U-shaped stairs. Intent is to aid in customer claims of slip and fall, decrease likelihood of vagrancy, vandalism and violence.
Stair Vestibules	X		Monitor	Dedicated camera to cover vestibules not covered by stair cameras. Intent/purpose: passenger security, investigation purposes, emergency situation, confined space monitoring.
Elevators	X		Monitor	Dedicated to view interior of elevator, viewing 2-way emergency call for assistance button and ability to view maximum area inside the elevator.
Elevator Vestibules	X		Monitor	Dedicated to view vestibule outside elevator, viewing 2-way call for assistance button and ability to view maximum area inside the elevator.
Elevator Lobby/Waiting Area	X		Monitor	Dedicated to view vestibule outside elevator, ability to view entire waiting area. Possibly more than one camera shall be used to achieve as close to 100% as possible.
Centrally Placed Elevators	X		Monitor	When an elevator is located in the middle of the tunnel and walkways exist on all sides, cover all walkways where possible. Note: strategic

				placement of tunnel cameras may assist.
Service Rooms	X		Monitor	Monitor door - can share camera with other service rooms if on same side of building
Entry / Exit points	X		Identify	Identify everyone who enters or exits through a controlled entry point.
Tunnel areas	X		Monitor	Dedicated to view entire tunnel area, overlapping cameras strategically placed to eliminate blind spots. If doors exist, fixed cameras to view any potential hiding areas.
Bus Platforms				
Area	Fixed	PTZ	Coverage Type (Image Quality)	Comment
Bus Shelters	X		Recognize	Inside bus shelters cover maximum area possible.
Bus Platform, Individual Bus Boarding area	X		Recognize	One camera for each bus platform, covering bus entry point.
Bus Bays	X		Recognize	One dedicated fixed per bay
Immediate area - away from obstructions		X		PTZ in vicinity of bus loop for operational use / security investigations / incident response / etc. This camera shall not be considered as coverage in any bus bay
Bridges, Connector Walkways				
Bridge main walkway	X		Monitor	Entire length multiple cameras cross coverage overlapping of cameras, no hiding spots or blind corners
Elevators	X		Recognize	Dedicated to view inside elevator, viewing 2-way emergency call for assistance button.
Elevator Vestibules	X		Monitor	Dedicated to view vestibule outside elevator, viewing 2-way call for assistance button and ability to view maximum area around the elevator.
Elevator Lobby/Waiting Area	X		Monitor	Dedicated to view lobby, ability to view entire waiting area. Possibly more than one camera shall be used to achieve 100% coverage.
Stairs / Escalator	X		Monitor	Dedicated camera to cover vestibules not covered

				by stair cameras
Service Rooms	X		Monitor	Monitor door - may share camera with other service rooms if on same side of building
Entry and Exit points	X		Identify	Identify everyone who enters or exits through entry and exits doors.
Two Way Communication Devices	X		Recognize	On longer bridges it may be necessary to have 2-way call devices, at those locations a dedicated fixed camera shall be installed to view call device.

Table 55: CCTV Camera Placement - Service Rooms, Service Buildings, Bunkers, Devices

Service Rooms/ Other				
Area	Fixed	PTZ	Coverage Type (Image Quality)	Comment
Treasury Rooms	X		Recognize	100% coverage, no blind spots
Operations Security	X		Monitor	General area coverage
Holding Rooms	X		Recognize	100% coverage, no blind spots
Security Office	X		Monitor	100% coverage, no blind spots
Secure Corridors	X		Monitor	100% coverage, no blind spots for entire path: Secure corridors to secure areas leading to secure areas. From building entry point to inside secure area 100% coverage, includes loading ramp.
Bus Cash in Rooms	X		Recognize	100% coverage, no blind spots
Service Buildings, Bunkers, Substations				
Perimeter	X	X	Monitor	Strategically place fixed cameras monitoring entire perimeter. One PTZ to monitor and investigate on each side of perimeter.
Communications Room	X		Monitor	Monitor door - can share camera with other service rooms if on same side of building
Electrical Room	X		Monitor	Monitor door - can share camera with other service rooms if on same side of building
Mechanical Room	X		Monitor	Monitor door - can share camera with other service rooms if on same side of building

Service Room (Storage, High value area)	X		Recognize	Monitor door - can share camera with other service rooms if on same side of building
Substations	X		Recognize	100% General area coverage using fixed cameras around perimeter of substation.
Devices				
TVM, ATM	X		Recognize	Dedicated coverage, shall not be able to read input of pin code
2 Way Call device	X		Recognize	Dedicated coverage of each device.
Gates	X	X	Recognize	Dedicated coverage of each device. PTZ to monitor gate area in addition to fixed
Emergency Call Buttons	X		Recognize	Dedicated fixed camera. (typically only in elevator)
Bell Phone	X		Recognize	Dedicated coverage of each device.

Table 56: CCTV Camera Placement - Facilities – Storage/Garage (Bus), Storage/Layover (Rail)

Bus Garage Storage Facility				
Area	Fixed	PTZ	Coverage Type (Image Quality)	Comment
Vehicle Gate ("main gate")	X	X	Recognize	Dedicated camera for vehicles, facial and plate recognition. 1 PTZ for investigation, live monitoring.
Pedestrian Gate ("man gate")	X	X	Recognize	Dedicated camera for pedestrian gate, facial recognition at control point. 1 PTZ for investigation, live monitoring. Note: If vehicular gate and pedestrian gate have sufficient proximity, 1 PTZ may be used for both.
Car Parking, Employees	X		Monitor	100% General coverage. Supplementary PTZ as required in the general area for live investigation.
Car Parking, Guests	X		Monitor	100% General coverage. Supplementary PTZ as required in the general area for live investigation.
Building Exterior	X		Monitor	View of entire sides, no hiding spots, blind spots. If obstruction exists add camera.

Building Entry Points - Vehicles	X		Recognize	Identify driver and plate
Building Entry Points - Pedestrian	X		Recognize	All pedestrian entrances shall have dedicated cameras
Property Perimeter	X	X	Monitor	Strategically place fixed cameras monitoring entire perimeter. One PTZ to monitor and investigate on each side of perimeter.
Cash Rooms	X		Recognize	100% coverage, no blind spots
Main Entrance	X		Identify	Dedicated camera for entry doors, facial recognition Head on view, not as side shot.
Elevators	X		Recognize	Dedicated inside elevator viewing maximum area with emphasis on the emergency call button. Passenger Security, Investigation purposes, confined space monitoring.
Elevator Vestibules	X		Monitor	Dedicated to view inside the elevator as much as possible and view the vestibule outside elevator, viewing 2-way call for assistance button and ability to view entire waiting area. Possibly more than one camera shall be used to achieve as close to 100% as possible.
Service Rooms	X		Monitor	Monitor door - can share camera with other service rooms if on same side of building
Loading Docks	X	X	Monitor	Coverage of entire loading dock, monitor any access control, point from loading dock to building
Loading Dock Man Door	X			Coverage of 2-way call device for access to building.
Bus Routes Internal	X		Monitor	General coverage
Bus Routes External	X		Monitor	General coverage
Bus Parking, Internal and External	X		Monitor	General coverage
Supplementary Coverage		X		PTZ camera(s) installed at locations which will provide direct line of sight to areas such as parking lot, gates, building entrances / exits , property perimeter.
Rail – Maintenance and Storage Facility/Layover				

Area	Fixed	PTZ	Coverage Type (Image Quality)	Comment
Vehicle Gate ("main gate")	X	X	Recognize	Dedicated camera for vehicles, facial and plate recognition. 1 PTZ for investigation, live monitoring.
Pedestrian Gate ("man gate")	X	X	Recognize	Dedicated camera for pedestrian gate, facial recognition at control point. 1 PTZ for investigation, live monitoring. Note: If vehicular gate and pedestrian gate have sufficient proximity, 1 PTZ may be used for both.
Car Parking, Employees	X		Monitor	100% General coverage including coverage for Metrolinx support/service vehicles. Supplementary PTZ as required in the general area for live investigation.
Car Parking, Guests	X		Monitor	100% General coverage. Supplementary PTZ as required in the general area for live investigation.
Building Exterior	X		Monitor	View of entire sides, No hiding spots, blind spots. If obstruction exists add camera.
Building Entry Points - Vehicles	X		Recognize	Identify driver and plate
Building Entry Points - Pedestrian	X		Recognize	All pedestrian entrances shall have dedicated cameras
Area	Fixed	PTZ	Coverage Type (Image Quality)	Comment
Property Perimeter	X	X	Monitor	Strategically place Fixed cameras monitoring entire perimeter 100%. One PTZ to monitor and investigate on each side of perimeter. 100% coverage using fixed cameras at each train entrance into a rail maintenance or layover yard, leading to it's rest position. PTZ cameras shall be strategically located for ongoing investigations.
Service Rooms	X		Monitor	Monitor door - can share camera with other service rooms if on same side of building

Lost & Found	X		Recognize	Entry to Lost and Found room and/or closet
Loading Docks	X	X	Monitor	Coverage of entire loading dock inside and out; monitor any access control point from loading dock to building. Camera(s) installed at locations which will provide monitoring of offloading areas (Sand, Fuel, DEF, Toilet servicing chemicals, holding tanks, etc..)
Loading Areas & Doors	X		Recognize	Coverage of 2-way call device for access to building. Note: All 2-way call devices at doors shall have coverage.
Rail Equipment	X	X	Recognize	Monitor length of parked train at each end looking in. One PTZ central location to monitor Rail movement between tracks Fixed camera to monitor wayside power cabinets as well as the connection point to the trains.
Equipment	X		Recognize	Fixed cameras to monitor the entire area around major pieces of shop equipment including but not limited to: - drop tables, - car & body hoist systems, - wheel truing machines Note: Additional critical shop equipment to be identified by the applicable business unit during the planning stages of a project
Area	Fixed	PTZ	Coverage Type (Image Quality)	Comment
Supplementary Coverage		X	Monitor	PTZ camera(s) installed at locations which will provide direct line of sight to areas such as parking lot, gates, building entrances / exits, property perimeter.

				High mast PTZ to be used to supplement 100% fixed camera coverage for investigative purposes. Locations to be coordinated with corporate security and operational business unit. Note: pole placement shall not interfere w/ operations.
Wash Equipment Rooms	X		Recognize	Provide 100% coverage using fixed cameras
Warehouse / Forklift areas	X		Monitor	Fixed cameras to monitor forklift activities throughout stores and along travel paths.
Wash bays	X		Recognize	Provide 100% coverage dedicated to the wash process, using fixed cameras
Maintenance Bays	X		Monitor	Fixed cameras to monitor all rolling stock movements into or exiting the maintenance bays. 100% coverage via fixed cameras. Interior and exterior as required.
Progressive Maintenance Bays	X	X	Monitor	Fixed cameras to monitor: Derails & blue flags outside of the maintenance bays, Fixed cameras to monitor train consist, entry into the building, Fixed camera coverage (100%) to monitor activities for the full length of the PM facility. PTZ placed in a supplemental fashion for investigation purposes.
Rail Maintenance Facilities	X	X	TBD	Additional coverage shall be provided according to requirements identified by Metrolinx during asset/infrastructure design
Note: Site specific CCTV requirements will be identified and incorporated for each project during the design stage.				

7.3.2 Public Address System (PA)

Public Address Systems are provided at bus terminals and rail stations for direct communication to passengers. These systems are used by Station Operations and Rail Operations and predominantly include rail and bus platforms, bus loops, passenger waiting areas, tunnels/stairways, and shelters. Announcements are made from a wall-mounted touch-tone DTMF paging phone located in the Station Service Area. This phone is compatible with the zone selection equipment in the Communication Control enclosure.

7.3.2.1 Coverage—Local

A system of speakers divided into zones enable announcements from the service counter throughout the station or to specific areas, e.g., tunnels or platforms. Under normal working conditions, pages are made using the all call feature to all areas.

7.3.2.2 Remote

Rail Station P.A. Systems can be accessed through existing VOIP interface to enable announcements to be made by Rail Operations at Union Station. This allows GO Operations personnel to access rail stations P.A. systems to make announcements.

7.3.2.3 Paging

Paging is presently conducted manually throughout the Rail System P.A. Network. However, both Union Bus and Rail Stations have the capability of automatically making pre-recorded announcements. An IP Ethernet link between these stations also allows access to either system. Replacement or new systems at bus and rail stations will contain provision for connection for any future system-wide IP network.

7.3.2.4 References

The design and installation of the P.A. System will comply with the following:

- Information Technology Telecommunications & Systems Document
- Universal Design Standard

7.3.2.5 Controller

The controller provides, through a system processor, audio input to the various groups of speakers, referred to as zones. This is accomplished by means of Zone Drivers and Zone Relay Cards. It also interfaces with the Red and Local Paging Phones

7.3.2.6 Dual Tone Multi Frequency (DTMF) Existing Systems

If required by GO Transit to phase out, disconnect, and remove an existing system, the Consultant shall specify that the Contractor turn over all removed and unused equipment to GO Transit. The process of phasing in the new system shall not cause any undue disruption to the services of the existing system.

7.3.2.7 System Requirements

The P.A. System generally consists of zone-grouped speakers strategically located in or at GO Transit facilities, buildings, tunnels, stairwell entrances, elevator vestibules, rail platforms, PUDO Areas, and Bus Loops, and a System Controller located in the Communications Room of the facility.

7.3.2.7.1 For Station and Terminal Facilities

The System shall accept local inputs from local phones and DTMF paging phone in the Service Area and a remote input from GO Transit 'RED' phone system (Bell Canada SST System).

7.3.2.8 Emergency Power

P.A. System equipment and auxiliary equipment shall be supplied from the emergency power panel located inside the station communication room.

7.3.2.9 Prioritized Paging

The P.A. system shall be user configurable to provide prioritized paging announcements when announcements are generated simultaneously from different inputs. Initial configuration shall establish to the following priority level.

Highest Priority

- GO Operations 'Red' Phone, Local 'Red' Phone

Lowest Priority

- Other Paging telephones including Service Area

The system shall provide for a separate 600-ohm audio input whose priority access level in the system is also user configurable.

The P.A. system shall interface with a maximum of seven and minimum of four P.A. paging phone inputs and up to three–600 ohm audio circuits. All three audio inputs shall provide independent audio adjustment of the incoming signal. A common audio adjustment shall also be provided for the P.A. paging phone inputs. Signal levels for the local paging and remote paging shall be separate inputs requiring individual adjustments. The equipment provided shall be capable of adjusting all audio inputs over a range of -30db to +6db.

A solid-state controller shall provide the switching and signaling required for priority calls, selective zone paging, zone “group” paging, all call, background music mute, paging alert tones and emergency override.

On-site user-configurable, prioritized paging access for audio inputs shall be provided. The P.A. system shall interface with the GO Transit ‘RED’ phone system to allow both ‘RED’ phone paging from Union Station and local ‘RED’ phone paging from the service counter. The local ‘RED’ phone paging facility shall automatically provide service counter paging speaker override whenever the local ‘RED’ phone system is used.

Group zone

- Selection codes shall be configurable through the system configuration menu
- The operation of VOIP phone shall automatically select independent user- defined ‘group’ zones

7.3.2.10 Audio Power, Coverage and Quality

The amplifier capacity of the system shall be determined by the number of speakers required to achieve the design criteria: three amplifiers minimum, as follows.

A minimum of two amplifiers shall be provided for the Platform area in order to maintain continuous system functionality. The amplifiers shall operate independently of each other. The first amplifier shall not be used to feed an audio signal to the second amplifier.

A third amplifier shall be provided to cover the PUDO area, Station building, tunnels, stairwell entrances, elevator vestibules, and if required, a third platform or bus platform.

The method of cable installation and speaker mounting on the rail platforms shall be arranged such that, not more than a 6dB drop shall be experienced whenever one amplifier fails.

Platform speakers shall be arranged in such a way as to maintain 50% coverage on each platform upon failure of a single amplifier.

For all areas, which require coverage, the P.A. system shall maintain a uniformly distributed sound pressure level measured at 1.5 m above floor level. The minimum sound pressure level at station platforms shall be 10dB above the measured ambient noise level to a maximum of 82dBA at day

Time hours and a maximum of 76 dBA at night time hours. The speech quality of the system shall be high and messages shall be clean and intelligible. There shall be no unwanted noise or spurious audio signals (20dB or less) emanating from the system.

A real time clock shall be used to provide the timing signals for volume adjustment. The real time clock shall run continuously even when power is removed and it shall maintain full date and time with automatic spring and fall Canadian daylight-saving time adjustments.

The P.A. system shall be designed to minimize unwanted noise at nearby residences in compliance with applicable noise control bylaws, shall these be less than the maximum values specified above, without however, reducing the effectiveness as an emergency voice communication system.

7.3.2.11 Components

7.3.2.11.1 P.A. System Controller Rack

- The P.A. System Controller shall be housed in a clear width 483mm (19") 35U rack enclosure having external dimensions of (559mm W X 635mm D X 1,500mm H) (22"W x 25"D x approx. 60" H)

7.3.2.11.2 Quick Disconnect Terminal

- All speaker cabling entering the communication enclosure shall be individually connected to a "quick" disconnect terminal
- The quick disconnect facility shall allow individual outgoing zone cables to be quickly disconnected from the controller without the use of a screwdriver
- The rail shall be marked to identify each respective zone/cable and incoming cables shall be tie-wrapped to rigid internal cable bars to prevent undue movement
- The termination rail also provides individual earth (ground) terminals to allow the screen of each zone cable to be grounded
- A laminated termination rail diagram, in addition to a control riser and/or single line block diagram shall be mounted on the inside of the rear door and a copy of such drawings shall also be included in the system manual

7.3.2.12 Surge Protection

An independent transient voltage suppression and surge protection device shall be provided meeting UL 1449 TVSS rating power source located at the bottom of the enclosure. All required control system power supplies shall be installed on a "quick disconnect" DIN rail.

7.3.2.13 Limiter Circuits

The enclosure shall incorporate all the required driver assemblies suitably wired to their respective control circuits and terminal rail connections.

7.3.2.14 Voltage Adjustment

The System Controller shall provide for automatic volume adjustment for configurable Day/Night time periods using an integrated real time clock in addition to automatic daylight saving time adjustment. The automatic volume adjustment shall be available for all input channels via the system controller.

7.3.2.15 PCB Cards (Printed Circuit Board Cards)

The System Controller shall include a 483mm (19") card frame shelf, with suitable backplate assembly to receive the following plug-in PCB cards:

- Amplifier
- Processor Control card c/w Real Time Clock Chip
- Zone Switch Card
- Zone Switch

- Paging Phone Interface
- Zone Driver Cards (quantity as required)
- Zone Relay Cards (quantity as required)
- Power Supply
- Back Plate

7.3.2.16 Zone Cards

- Each Zone Card shall provide independent audio level adjustment, all audio inputs shall have independent level control in order to adjust incoming signal
- Any audio channel shall be capable of automatically being connected to any combination of zones for broadcast of P.A. messages
- “Power On” and “Status” LED indicators shall be provided on the front panel of the Display Card in addition to a processor reset button. All system processor modules shall be interchangeable
- All P.A. system components shall be protected by electrical current limiting and thermal overload devices

7.3.2.17 Amplifiers

- Amplifiers in the P.A. rack shall provide input for telephone and microphones
- Amplifiers shall have automatic voice limiter circuit to compensate for varying voice levels and paging styles
- Amplifiers shall include RFI filtering, input/output overload protection, and open short circuit protection

7.3.2.18 Speakers—Outdoor Pole-Mounted

7.3.2.18.1 Mounting

- Speakers shall be outdoor weatherproof types mounted on lighting poles in such a manner as to eliminate the necessity of drilling the lighting poles (by stainless steel banding) and to provide resistance to vandalism
- Speakers shall be resistant to the environment and provide for the direct entry of any connected P.A. cable
- Speakers shall use an NPT threaded gland entry with liquid tight cable gland and be coupled to the pole gland plate using liquid tight flexible conduit
- No exposed P.A. cable is allowed. Refer to GO Standard Electrical Drawings

7.3.2.18.2 Height

- The mounting height for speakers on light standards shall be generally 4m above grade

7.3.2.18.3 Audio Coverage

- The distance between speakers and the number of speakers required to achieve the specified audio coverage will depend upon the station's inherent acoustic properties and the locations of the light standards and shelters on the platform

7.3.2.18.4 Temperature

- The operating temperature shall be between -30 °C to 70 °C

7.3.2.18.5 Features

- Line voltage 70V and maximum wattage 15W RMS continuous
- Full adjustment in both the vertical and horizontal plane
- Speaker Format shall be dual cone phenolic impregnated resin manufactured with 70V multi-tap transformer and a sealed back for extra protection and audibility

7.3.2.19 Speakers–Indoor

7.3.2.19.1 Surface and Recessed Types

- Speakers shall be dual cone, treated paper design with a built-in 70V multi-tap transformer
- A steel baffle or suspended ceiling tile support bridge and back box shall be provided for either flush or surface mounting applications to suit the location
- The speaker's back box shall be supported independently of the grid in a ceiling tile application
- The finish shall match location colour or as required by GO Transit
- Speakers in public areas shall be flush mounted or camouflaged whenever possible
- The Consultant shall co-ordinate flush or surface mounted locations with the architect

7.3.2.19.2 Volume Control in Waiting Areas

- Flush mounted speakers shall incorporate an integral volume control accessible from the front baffle plate that shall provide attenuation of 20 dBA at any wattage tap

7.3.2.19.3 Temperature

- Operating temperature range shall be within 0°C to 50°C

7.3.2.19.4 Features

- Line voltage 70V and maximum wattage 10W RMS continuous

7.3.2.20 Speakers–Shelter and Tunnel

7.3.2.20.1 Housing

- Speakers shall have a vandal resistant diecast housing complete with stainless steel tamper-resistant "TORX" screws to prevent unauthorized access (Phillips or Robertson screws are not acceptable)

7.3.2.20.2 Output and Power

- Speakers shall be designed for maximum output at a minimum power loss and shall be installed in accordance with manufacturer's recommendations

7.3.2.20.3 Format

- Speakers shall be sealed dual cone construction and manufactured of phenolic impregnated resin
- Speakers shall incorporate a sealed back for extra protection and audibility. They shall be white in colour or finished as required by GO Transit

7.3.2.20.4 Brackets

- When used in exposed areas or inside tunnels, a stainless steel speaker-mounting bracket must

be used

7.3.2.20.5 Features

- Line voltage 70V and maximum wattage 8W RMS continuous
- Operating temperature range of -30°C to +50°C

7.3.2.21 Installation

7.3.2.21.1 P.A. Cabling

- All cables shall be run in a neat and orderly fashion in a conduit system
- P.A. cables shall be designated at both ends as per information supplied on tender
- All cables that run from speakers to terminating equipment shall be single length (splices in these cables are not allowed—that is: no splices in conduits)
- Sufficient slack (1 meter) shall be left in case it is necessary to re-terminate the cable
- Emergency power—all systems and components shall be powered via a single source from the emergency power panel

7.3.2.21.2 P.A. Cabling Specifications

- AWG: 14
- Stranding: 41 x 30
- Conductor: TC, 2 conductors
- Insulation: 0.02" Polyolefin
- Capacitance: 30 pF/ft. (conductor to conductor)
- 58 pf/ft. (1 cond. and other cond. connected to shield)
- Shield: Delfoil Aluminum/Polyester
- Jacket: Blue or White Polyvinylchloride (depending on application)
- Nom. Cable OD: 0.302"
- Voltage: 600
- Temp: 80°C
- Weight: 56 lbs/mft
- CSA: AWM, CMG
- UL: CM
- Flame Test: FT4
- Application: 70V PA Speaker Applications

7.3.2.21.3 Conduits

- Conduits shall be designated with "P.A." at terminating ends
- Wiring shall be run in conduit
- Outdoor cable shall be run in epoxy coated galvanized rigid steel; indoor cable may be R.G.S. or E.M.T. depending on the location

- All underground conduits shall be Rigid PVC

7.3.2.21.4 Connections

- All speakers connected in a single zone shall be run in a single line configuration
- All splices or connections shall be copper-to-copper compression type with insulating covers
- Poles with speakers shall have one metre slack cable in raceway
- Fish cord in all P.A. raceways shall be installed for future use

7.3.3 Telephone Network

The main telephone switch shall consist of trunk lines supplied as either individual or T1 circuits to allow for local and/or long distance calling. The network is to be capable of interfacing with 4-digit dialing as well as integrating with the voice mail system.

Telephone switches at remote sites such as Middlefield or Wolfdale shall be linked to the main switch at Head Office to permit 4-digit dialing between all sites.

All systems are to be provided with backup power supplies from Uninterruptible Power Sources at each location and where available by generator power.

The network shall be capable of permitting paging to be performed through the local telephone system at all stations.

Provision shall be made for local caller I.D., call hold, call waiting, transfer, and conferencing.

Individual telephones shall be speaker type, capable of accepting multiple lines and speed dialing.

Conduits and power for the telephone network shall be provided at each trunk switch location.

7.3.4 Talk-Thru System

The talk-thru system provides instant 2-way voice communication between the public and station attendants through the glass divider at the station service counter.

The talk-thru unit provides hands free and effective duplex communication between the station operator and the passengers. The voice switching function is automatically biased in the direction from the passenger to the operator. Noise cancelling and omnidirectional microphones will be mounted on the passenger and service attendant sides respectively, of the booth glass divider. Two rotary encoded controllers will be provided to adjust the volume of each microphone. The operator's boom microphone will automatically override the passenger microphone when activated. Provision will be made for inter speech pause time. Components:

- Microphone Override Pushbutton
- Power On/Off L.E.D. Switch
- Noise Cancelling Microphone
- Seller's Mike-Off Switch
- Wiring-Conduits and 120 volt A/C source power outlets for each voice link assembly

7.3.5 Security Systems

Security at GO Transit Rail and Bus Stations is managed by integrated access control and alarm systems. These systems are supplied and installed, as well as monitored by Chubb Security Systems on a 24-hour basis.

7.3.5.1 Access Control

Entry into the station sets off the time-delay actuated intrusion alarm, which is disarmed by entering an accepted.

7.3.5.1.1 I.D. code in the system keypad

The alarm control panel will continue to monitor all connected functions except the intrusion alarm sensors. When the premises are exited, re-entering the accepted I.D. code will reactivate the intrusion alarm. Designated employees are provided with individual I.D. codes to permit access into the premises. Time and date are recorded at central monitoring stations at the East and West Region facilities.

7.3.5.2 Building Alarms

Actuation of any equipment failure or fire alarm devices will cause a digital signal to be transmitted to Chubb Security central alarm monitoring location, as well as the local keypad. Activation of a hold up pushbutton will cause a silent signal to be transmitted to the Chubb central monitoring location, indicating where the alarm originated.

Stations and facilities operations personnel shall be consulted prior to final design.

7.3.5.3 Alarm Systems

Devices are strategically located throughout the buildings to detect and alarm the following conditions:

- Intrusion
- Smoke
- Low Temperature
- High Temperature
- Hold Up (manually operated by the Station Attendant)
- Sump Pump Failure
- Inverter and UPS Failure
- Low Voltage (station main power supply)

7.3.5.4 General Features

The complete station alarm system shall include, but not be limited to, the following components:

- Chubb AFX Control Panel
- AFX User Interface
- Signal Transmitter and Receivers
- Audible Signal Device
- Hold-Up Alarm Buttons
- Intrusion Detectors, IR, PIR and ultrasonic
- Smoke Detection Devices
- Low and High Temperature Sensors
- Inverter System–Trouble and AC Output Sensors

- Smoke Detector By-Pass Switch
- Central Commercial Monitoring Services

7.3.5.5 Alarm Monitoring Equipment

7.3.5.5.1 Chubb alarm Control Panel

The system controls are housed in a surface wall-mounted EEMAC cabinet either with a hinged lockable door and gasket or a secured by screws for tamper protection. A tamper switch is included to provide an alarm in the case of tamper for the latter protection.

The alarm control panel is microprocessor controlled for monitoring 8 to 128 zones including the following:

- Fire alarm detection with smoke detectors
- Intrusion alarm with dual microwave and infrared motion detectors
- Hold up alarm from high collar pushbuttons
- AC power failure, voltage sensor relays
- Low station temperature alarm
- Inverter system–trouble and AC failure output sensors
- Alarm system trouble/low battery condition
- Annunciation time delay devices for voltage sensors and thermostats

System Test momentary contact push-buttons are provided to test the alarm control functions including alarm output and telephone transmission. A manual “System Reset” push-button is provided to reset each alarm function at the keypad after the initiation devices have been set. An “Alarm Signal Silence” push-button in the alarm control panel is provided at the keypad to silence the audible alarm signals. An 8,192 event memory is either retrievable on site or from a remote PC located at a central facility. The system shall be subdivided from 2 to 16 areas that can carry up to 4,000 programmable codes, with 50 levels of authority. The system shall have false alarm prevention zones. All zones to be displayed on a liquid crystal display.

7.3.5.6 Power Supply

A 12 volt DC power supply for all system supervision, control and alarm functions shall be provided in the alarm control panel as an integral part of the system, complete with sealed gel type batteries and solid state charging equipment through 120 volt, 1 phase, 60 Hz normal power supply and step down transformer.

The battery capacity will be sufficient to operate supervisory conditions for a minimum of 12 hours, including audible alarm signals and auto-dialer and at the end of this period to energize all alarm devices simultaneously for a period of 5 minutes continuously.

The automatic charger shall be capable of restoring 90% of dead battery capacity within 12 hours. Discharge protection shall be provided to disconnect the charger when the voltage drops below 60%. The system shall report locally on the display loss of power and battery failure.

7.3.5.7 Audible Signal Device

The audible signal device shall be a vibrating horn with 110dB rating for intrusion and fire, operating at 12 volt DC.

7.3.5.8 User Interface

The user interface shall be surface mounted with tamperproof alarm. This unit will be used for entering application-oriented commands such as BA day-set/night-set, silencing audible annunciation and programming of access codes, etc. It contains a sounder and a liquid crystal display, which annunciates zones and system status. Shall more than one alarm be registered at the same time, the liquid crystal display will scroll through all alarms.

7.3.5.9 Intrusion Detector

Dual technology (microwave and infrared) motion detectors shall have Fresnel lenses, multi-segment mirrors, and automatic temperature compensation.

7.3.5.10 Smoke Detector

A single zone, single state detection system shall be installed. The photoelectric combustion detector is of solid-state design, surface or flush mounted. At stations with an existing Fire Alarm Panel, the output contacts will be wired to The Alarm Control Panel.

7.3.5.11 Hold-Up Button

The hold-up push-buttons shall be of the high collar momentary type.

7.3.5.12 Low Temperature Sensor

The temperature sensor shall have an adjustable setting with a scale from 10C to 30C. The thermostat shall be housed in a vandal-resistant enclosure with maximum air circulation over the sensing element.

7.3.5.13 AC Voltage Sensor

The AC voltage sensor shall be of solid-state type with adjustable pick up and drop out settings and sensing relays with dry rated switching contacts.

7.3.5.14 Inverter System

The inverter unit shall have trouble and AC output failure alarm settings as provided by the manufacturer. Dry output contacts from the Inverter shall be wired to the security control panel.

7.3.5.15 Trouble Alarm Set

AC Failure: Shall indicate failure of AC supply to the unit.

One General alarm and one AC output fail alarm shall be supplied.

Low Battery Voltage: Shall indicate the battery voltage has fallen below a pre-set limit during the discharge process.

High Battery Voltage: Shall indicate that the battery voltage has risen above a pre-set limit during the charging process.

Charger Failure: Shall indicate the charger is not providing any output to the batteries.

The occurrence of any of the above conditions will provide a common alarm.

7.3.5.16 AC Failure Output Alarm Set

No AC Output: This alarm shall trigger upon the absence of AC output for any reason.

7.3.5.17 Smoke Detector Bypass Switch

A smoke detector bypass pushbutton switch, a double contact shunt switch, shall be provided to indicate to central monitoring that the detector is in the by-pass mode.

7.3.5.18 System Functional Performance

Actuation of any intrusion alarm-initiating device will cause the system local alarm panel to operate as follows:

- To transmit a signal, depending on the location and type of alarm, to a central alarm monitoring location and to annunciate on the local keypad
- An audible alarm signal in the station will sound continuously for 5 minutes and then be automatically silenced

Actuation of any fire alarm initiating devices will cause the system local panel to operate as follows:

- To transmit a digital signal, depending on the location and type of alarm, to a central alarm monitoring location and to annunciate on the local keypad
- Actuation of a hold-up push-button will cause the alarm control panel to transmit a silent alarm to a central alarm monitoring location, identifying to the operator the station where the alarm originated and the type of alarm

Actuation of a thermostat for low temperature, AC power failure, inverter system trouble, or security system trouble, will cause the alarm panel to:

- Transmit a digital signal, depending on the location and type of alarm, to a central monitoring location and to annunciate on the local keypad after the pre-set time delay has expired
- An audible signal in the keypad will sound continuously for 5 minutes and be automatically silenced

7.3.5.19 Sequence of Operation

The following is a typical procedure for entry into and exit from a station:

- Entry – The designated door is unlocked and the time delay intrusion alarm is immediately activated
- The alarm is disarmed by key-in at the keypad located in the station before expiry of the time delay
- If the code is accepted, the intrusion alarm is disarmed and the alarm control panel will continue to monitor all the connected functions except the intrusion alarm sensors
- Exit – The exit code is entered in the keypad and the system will respond by initiating the time delayed intrusion alarm
- The station must be exited and the door locked before the end of the time delay
- The system will respond at the end of the time delay by arming all of the intrusion sensors

7.4 Mechanical

7.4.1 Overview

This section applies to the mechanical engineering design related to:

- Heating, Ventilation and Air-Conditioning (HVAC) systems
- Building Automation System (BAS)
- Radiant Floor Heating and Snow Melting Systems
- Plumbing and Drainage systems
- Fire Protection systems
- Identification, Appearance and Noise Vibration
- Basic and user-friendly computerized and automated equipment controls and energy-management programs shall be utilized. Remote monitoring of equipment shall be provided if required by Metrolinx

Refer to GO Standard specifications and drawings for detailed requirements

7.4.2 Heating, Ventilation, and Air Conditioning (HVAC) Systems

7.4.2.1 Design Requirements

Heating, Ventilation and Air-Conditioning System shall be by means of the most cost-effective energy source available at the site. Daytime design temperatures (Daytime: with Nighttime setbacks) for rooms shall be as tabulated below.

Table 57: Heating, Ventilation, and Air Conditioning (HVAC)

Room	C Winter Min.	C Summer Max	Energy Source
Passenger Waiting Room (including vending/ concessions)	18	25	HVAC
Station Attendant	22	22	HVAC
Staff Room	22	22	HVAC
Dispatcher Room	22	22	HVAC
Office Room	22	22	HVAC
Communication room	15	22	HVAC (Note 1)
Electronics Workshop	22	22	HVAC
Washroom	22	N/A	Ventilation & Heating

Janitor Room	18	N/A	Ventilation & Heating
Battery Room	18	N/A	Ventilation, Heating & Gas Monitoring
Electrical Room	15	25	HVAC (Note 1)
Mechanical Room	18	N/A	Ventilation & Heating
Maintenance Room	18	25	HVAC
Boiler Room	18	N/A	Ventilation, Heating & Gas Monitoring
Elevator Hoistway	15	25	HVAC (Note 2)
Workshop	22	22	HVAC
Storage Room	20	22	HVAC
Station secondary entrance, tunnel, and pedestrian bridge	N/A	N/A	Ventilation
Hydro Vault	N/A	N/A	
Shelter	N/A	N/A	Note 3

Notes:

1. For HVAC system detail requirement refer to service rooms requirements in section F.
2. For HVAC system detail requirement refer to Elevators in section D.
3. For HVAC system detail requirement refer to GO-Shelter standard drawing and specification.

7.4.3 Stations

- Heating and Air Conditioning of the waiting area and the service area shall be achieved by energy efficient, premium quality air handling unit c/w outdoor condensing unit, or roof top unit depending on different projects, Equipment shall be accessible for operations and maintenance.
- The service area will have a VAV box controlled by a thermostat, while the main thermostat shall be located in the maintenance room and interlocked with the waiting area temperature sensor.
- Communication room and Electrical room shall have a dedicated split Heat Pump A/C unit, fan-forced heater as redundancy, and emergency cooling for each room, for detail refer to service room requirements in section F.
- Depending on area, washrooms shall be ventilated by Energy Recovery Ventilators or exhaust fans, and shall be heated by radiant heating (if available in the building) or by electric baseboard heating.
- HVAC system shall be provided for Elevator hoistway. For detail, refer to Elevators in section D.

7.4.4 Facilities

- Radiant floor heating shall be the main heating system in the entire facility
- Office area shall be heated and air conditioned by energy efficient, premium quality rooftop packaged gas heating/electric cooling units
- Storage area and repair area shall be ventilated by heavy-duty industrial Air Handling Unit c/w heat recovery unit.
- This system shall be controlled by thermostats and gas monitoring system.
- To minimize infiltration through open overhead doors in rail facilities, heavy-duty industrial air curtains shall be installed above overhead doors.
- Communication room and electrical room shall have a dedicated split Heat Pump A/C unit, fan-forced heater as redundancy, and emergency cooling for each room. For detail refer to service room requirements in section F.
- Large Communication room and/or Computer room shall have an independent dedicated HVAC system including precision air conditioning equipment and under floor plenum supply. The complete HVAC system shall comply with ASHRAE Thermal Guidelines for Data Processing Environments.

7.4.5 Air Curtain

- For high-traffic door locations, or where drafts are a problem with station attendants, linear diffuser air-curtains shall be provided at the doors.
- Refer to Metrolinx Standard Air Curtains Specification 23 33 45 for detailed requirements

7.4.6 Split Heat Pump Unit

- Refer to Metrolinx Standard Split Type Air to Air Heat Pumps Specification 23 81 26 for detailed requirements.

7.4.7 HVAC Air Distribution

- Refer to Metrolinx Standard HVAC Air Distribution Specification 23 30 00 for detailed requirements.

7.4.8 Air Terminal Unit

- Refer to Metrolinx Standard Air Terminal Units Specification 23 36 00 for detailed requirements.

7.4.9 Custom Made Air Handling Unit

- Refer to Metrolinx Standard Custom Made Air Handling Units Specification 23 75 00 for detailed requirements.

7.4.10 Piping and Pumps

- Refer to Metrolinx Standard HVAC Piping and Pumps Specification 23 20 00 for detailed requirements.

7.4.11 Fan

- Airfoil or backward inclined design is preferred
- Forward curved wheels may be used for low pressure applications
- Variable pitch axial fans shall be considered for fan wheel diameters greater than 610mm and where system air volumes vary, due to control characteristics of summer/ winter operation
- Propeller fans may be used where they serve non-public or unoccupied areas
- Additional ventilation with emergency power backup may be required in large facilities.
- Refer to Metrolinx Standard HVAC Fans Specification 23 34 00 for detailed requirements.

7.4.12 Energy Recovery Ventilator

- Energy Recovery Ventilator (ERV) shall be specified for energy conservation in all Metrolinx facilities and stations, where practical and cost effective
- In station building they shall be above the public washrooms or the maintenance room, in the ceiling space, where applicable
- Access by ceiling hatch sized accordingly. Provide engineered tie off points if access is higher than 3m after finished floor.
- Refer to Metrolinx Standard Energy Recovery Ventilators Specification 23 33 65 for detailed requirements.

7.4.13 Air Filter and Accessory

- Filters used in supply air systems shall be 50 mm (2") thick throwaway type minimum efficiency of 30%
- Refer to Metrolinx Standard Air Filters and Accessories Specification 23 41 00 for detailed requirements

7.4.14 System Control

- HVAC systems shall be controlled using programmable thermostats to achieve night setbacks and BAS compatible
- Interlocks for fire protection to be as per OBC and NFPA
- If a room has two HVAC systems, both systems shall be controlled by a single programmable automatic heating/cooling changeover controller

7.4.15 Heater

- Electric fan forced heaters shall be considered in the waiting area and entrances. Heaters can be wall or ceiling mounted. Heaters shall be controlled by wall mounted space sensors. No built-in thermostats shall be allowed.
- Supplemental electric fan forced heater shall be considered in the service area.
- Electric resistance duct heaters shall have Silicon Control Rectifiers (SCR), minimum airflow switch, and two high-temperature limit sensors.
- Gas fired unit heaters and infrared heaters shall be considered in large facilities.

- Electric infrared radiant heater shall be considered, refer to Metrolinx standard shelters.
- Refer to Metrolinx Standard Heaters Specification 23 83 00 for detailed requirements

7.4.16 Diffuser

- Diffusers shall be aluminum
- For perforated metal ceilings diffusers to be perforated type to match the ceiling profile and colour
- Refer to Metrolinx Standard HVAC Air Distribution Specification 23 30 00 for detailed requirements.

7.4.17 Duct

- Air ducts shall be galvanized sheet metal conforming to ASHRAE, SMACNA Duct Construction Standards, and NFPA 90A.
- Diffuser branch-ducts and air terminal ducts may be circular metal flex-ducts where concealed.
- Exposed ducts in public areas shall be aluminum spiral ducts. Hangers and fasteners shall also be protected from the detergents and moisture or be fabricated of materials that are not subject to corrosion.
- Refer to Metrolinx Standard HVAC Air Distribution Specification 23 30 00 for detailed requirements

7.4.18 Fire Damper

- Fire dampers shall be fusible link type conforming to ULC-S505.
- An access door shall be installed for inspection and resetting.
- Refer to Metrolinx Standard HVAC Air Distribution Specification 23 30 00 for detailed requirements.

7.4.19 Connector

- Flexible connectors shall be provided between vibrating equipment and connecting ducts.
- Refer to Metrolinx Standard Basic Mechanical Materials and Methods Specification 20 05 10 for detailed requirements

7.4.20 Insulation

- Acoustical and thermal duct insulation shall be in accordance with the OBC. and ASHRAE 90.1.
- Acoustical insulation shall be provided to maintain a maximum room sound rating of 40dBA.
- Piping insulation shall be in accordance with ASHRAE 90.1, with PVC jackets.
- Refer to Metrolinx Standard Mechanical Insulation Specification 20 05 25 for detailed requirements

7.4.21 Rooftop Air Handling Unit

- High efficiency, meeting ASHRAE 90.1 requirements, UL listed and labelled.
- Units supplying high occupancy rooms, such as meeting rooms, shall be controlled by a

carbon dioxide sensor, in order to modulate the outside air damper

- Factory installed downflow economizer c/w barometric relied damper, solid state enthalpy, and differential enthalpy control
- Refer to Metrolinx Standard Rooftop Air Conditioning Unit Specification 23 74 17 for detailed requirements

7.4.22 Fuel Oil System

- Refer to Metrolinx Standard Fuel Oil System Specification 23 11 13 for detailed requirements

7.4.23 Natural Gas Piping System

- Refer to Metrolinx Standard Natural Gas Piping System Specification 23 11 23 for detailed requirements

7.4.24 Refrigerant Piping System

- Refer to Metrolinx Standard Refrigerant Piping, Valves and Accessories Specification 23 23 00 for detailed requirements

7.4.25 Building Automation System (BAS)

All facilities, stations, and terminal buildings shall have a central computer-based, Building Automation System installed that will control and / or monitor the following building systems at a minimum:

Table 58: Building Automation System (BAS)

Mechanical	Electrical	Communications
<ul style="list-style-type: none"> • HVAC system • Plumbing and drainage system • Compressed air system • Vehicular and Pedestrian Gates and Doors • Fuel System • Gas Detection Systems • Well water systems, if applicable • Alarms system • Compressed air dryers • Fire protection system • Snow melting system • In Floor heating system • Natural gas system 	<ul style="list-style-type: none"> • Power Systems • Lighting Systems • Controllers • Shelter Heater System • Panel Loads per circuit • SCADA Remote Monitoring • All third party (retail, users) power • Environmental readings • Radio Systems (power consumption) • Monitoring of signalling system 	<ul style="list-style-type: none"> • Telecommunications Systems (excluding CCTV) • PA and Intercom Systems • Security and Access Management Systems • All Systems on site including car counting system. • Car Counting System,

<ul style="list-style-type: none"> • All third party (retail, users) water and gas • Layover Systems including Sand, Fuel, Air and Track Load 	<p>capability</p> <ul style="list-style-type: none"> • Hydro • Generator, UPS and Emergency Power Systems (loss of power, monitoring of damper status, batteries status and alarms) • Layover Systems 	
---	--	--

- Provide sub-metering for panels and sub-panels with remote communication capability from IT Central Gathering Centre. The system shall be able to store data for a minimum of three (3) years.
- The local BAS shall be able to communicate and send information to an IT Central Gathering Centre.
- The location of the BAS control panel and location of the outlets is to be included on the electrical drawings.
- BAS shall be part of the commissioning process. Two full years are necessary before final commissioning of the BAS system.

7.4.26 Radiant Floor Heating and Snow Melting Systems

7.4.26.1 Design Requirements

Radiant Floor Heating and Snow melting Systems shall refer Metrolinx Standard specifications and Standard drawings for detailed requirements, typical applications include:

7.4.26.1.1 Stations

- Full width hydronic snow melting system shall be installed on all rail platforms, and exterior ramps and stairs leading to platform area.
- Radiant floor heating shall be installed in Station building except mechanical room, communication room and electrical room.

7.4.26.1.2 Bus Operation Facilities

- Radiant Heating system shall be installed in all Bus Facilities.
- Partial snow melting system shall be provided at bus facility ramped entrances.

7.4.26.1.3 Rail Operation Facilities

- Radiant Heating system and snow melting system shall be installed as directed by Metrolinx.

7.4.27 Plumbing and Drainage Systems

7.4.27.1 Basis of Criteria

This Section deals with plumbing systems, building storm and sanitary drainage systems, compressed air

systems and special applications within the immediate vicinity of any building. Refer to GO Standard specifications and drawings for detailed requirements

Typical Applications include:

- Distribution
- Elements
- Fixtures
- Storm and Sanitary Drainage
- Special Applications
- Staff washrooms
- Public washrooms
- Tenant and vending premises
- Bus and rail maintenance facilities
- Hose bibs at buildings, tunnels and on platforms
- Sump pits for tunnels, elevators and buildings (if applicable)

Specialized installations include:

- Vehicle wash equipment
- Progressive maintenance bays (PMBs) for locomotive and coach water supply and sewage disposal
- Wells and septic systems or holding tanks at rural sites

7.4.27.2 Design Requirements

7.4.27.2.1 Water Piping

- Domestic water piping shall be copper, type "L" above ground, type "K" for buried services. Copper type "M" and galvanized pipe shall not be used.
- Hangers and fasteners shall be protected from the detergents and moisture or be fabricated of materials that are not subject to corrosion.
- Waterlines in unheated areas shall be protected from freezing with electric tracing, thermostatically controlled. These sections of piping shall be valved to enable isolation and drainage.
- Insulation shall be in accordance with ASHRAE 90.1 standard.
- Piping shall be concealed in public areas. Exposed chrome piping shall have chrome-plated anchors and hangers.
- Pipes shall not be routed through electrical rooms, control rooms or communication rooms.
- Cathodic protection for buried pipes shall be provided if required.

7.4.27.2.2 Hot Water System

- Where gas is available, gas type DHW tank shall be provided.
- Service hot water shall be provided tempered 40°C at station and bus terminal washbasins and in

washrooms. Shops, maintenance and garage facilities may have higher temperatures if required.

- A re-circulation system normally is not required in a typical Metrolinx/GO Station building.
- Hot water heaters in stations/bus terminals shall be located in maintenance rooms, ceiling-hung to suit space requirements. Relief valves shall be piped to floor drains with air break.
- A gas fired tankless type hot water system may be used where approved by Metrolinx/GO, to minimize piping.

7.4.27.2.3 Landscape Water System

- Buried water supply piping systems shall be provided for the manual watering of landscaping only if specifically requested by Metrolinx/GO. If requested, they shall consist of PVC piping and quick coupling hose attachments spaced so that every point in the landscaped area can be reached by a 30 m hose extended from the hose attachment.
- The system shall be capable of being completely drained or air-blown dry in the autumn

7.4.27.2.4 Storm Drainage System

- Drainage shall be designed to meet the requirements of local authorities, and the relevant stormwater management study.
- Drainage: oil and grit interceptors and inlet control devices may be required.
- The location of scupper drains and splash pads shall be coordinated with the prime consultant.
- Rail platform shelter roof drains where required, may be directed to Railway R.O.W. ditches, where approved by the Railway, or to a sump pit in the tunnel and then pumped to the storm system.

7.4.27.2.5 Sanitary Drainage System

- Drainage shall be designed to meet the requirements of local authorities.
- All washrooms, maintenance/janitor rooms, mechanical rooms, vending and concession areas and certain maintenance areas as directed by Metrolinx, shall be provided with floor drains and strainers.
- Strainer and sediment buckets shall be provided for heavy-duty floor drains, trench drains, and tunnel floors. Tunnels shall have open shallow trench drains at the wall perimeters.
- Food preparation areas require grease interceptors. This applies particularly to tenant premises.
- Service stations, repair shops, and garages require oil interceptors. Parking lots and elevator pits do not require oil interceptors as per O.B.C.

7.4.27.2.6 Hydrants and Hose Bibs

- Wall hydrants and hose bibs shall be minimum 20 mm anti-siphon, non-freeze type in flush mounted box with locking cover and located at buildings, tunnels and on platforms to suit maintenance requirements as directed by Metrolinx.
- Tunnel/platform hose-bib pipe systems shall have gravity drain capability for water shut-off.
- Hose-bibs shall also be located in shops, maintenance facilities, loading docks, bus platforms, etc. as directed by Metrolinx, sized to suit.
- Refer to Metrolinx Standard Domestic Water Piping and Specialties Specification 22 11 00 for detailed requirements

7.4.27.2.7 Pipe Sleeves

- Galvanized steel pipe sleeves shall be provided in concrete structures to accommodate future piping installations, if required.
- Hangers and fasteners shall also be protected from the detergents and moisture or be fabricated of materials that are not subject to corrosion.
- Refer to Metrolinx Standard Basic Mechanical Materials and Methods Specification 20 05 10 for detailed requirements

7.4.27.2.8 Water Meters

- Water supply lines shall be sized for the specific requirements of the facility.
- The incoming service shall be metered inside with an exterior readout acceptable to the local utility.
- Major tenants shall have check-meters.
- Valves: Each fixture shall have a key operated service valve or shut-off valve. All valves shall be labelled with a metal tag.
- Back flow preventers shall be provided.
- Additional shut-off valves shall be provided for each group of fixtures, e.g., a washroom. At least one shut-off valve shall be provided for each room with one or more fixtures.
- Refer to Metrolinx Standard Domestic Water Piping and Specialties Specification 22 11 00 for detailed requirements

7.4.27.2.9 Sump Pumps

- Where storm or sanitary drains cannot be discharged to the sewer by gravity flow, flow shall be discharged into a tightly covered and vented sump pit, from which the liquid is lifted and discharged to the sewer by an automatic duplex pump system with automatic changeover and guide bars. Each pump shall be sized for 100% flow. Pumps shall be epoxy coated with two independent seal assemblies.
- A 4-float control system shall be provided (OFF-LEAD ON-LAGG ON-ALARM). Provision shall be made for dry 'C' contacts for connection to a remote alarm. Pumps shall be easily removable for maintenance without the need to enter the wet well. Control system shall be enabled without the use of any proprietary programming involved.
- Pit cover shall be gas tight, self-opening with piston kit and safety grid.
- System shall be complete with lifting equipment including lifting davit, chain hoist, lifting device, and chain hook.
- Sump pits are used for shelter, roof, and tunnel drainage, and in elevator or escalator pits.
- Special sump pumps may be required for maintenance facilities or rural stations (TBD).
- Refer to Metrolinx Standard Plumbing Equipment Specification 22 30 00 for detailed requirements.

7.4.27.2.10 Plumbing Fixtures

- All fixtures except janitor sink shall be vandal resistant vitreous china Certified to CAN/ CSA-B45.0, "General Requirements for Plumbing Fixtures"
- All trims to be touchless, electronic, hard-wired barrier free where applicable.

- Refer to Metrolinx Standard Plumbing Fixtures and Trim Specification 22 42 00 for detailed requirements.

7.4.27.2.11 Compressed air system

- Refer to Metrolinx Standard General Service Compressed Air System Specification 22 15 00 for detailed requirements.

7.4.27.2.12 Special Requirements

- Septic systems and/or holding tanks for rural facilities
- Filling stations for locomotive and coach washroom water supply.
- Coach washroom sewage removal facilities at PMBs in train maintenance facilities
- Train and bus wash facilities including recycling of wash water
- Wells or water reservoirs at rural facilities to approval of authorities having jurisdiction, including filtration and purification systems
- A minimum Metrolinx requirement is ultraviolet purification for coliforms and E.coli bacteria with pre-filters
- Thermostat controlled electric pipe heating cables shall be used on all water pipes in unheated areas, where the temperature may fall below freezing
- Minimum burial depth of piping shall be 1650 mm or to municipal requirement

7.4.28 Fire Protection Systems

7.4.28.1 Design Requirements

Fire Protection System shall be provided as per Ontario Building Code, NFPA, Ontario Fire Code and Regulators, and refer Metrolinx Standard specifications for detailed requirements.

Table 59: Fire Protection System

Item	Features
Sprinkler System	<ul style="list-style-type: none"> • Sprinkler heads in public areas shall be concealed flush type. • Drum drips shall be insulated and electrically heat traced, with dedicated circuits • Pre-action sprinkler system shall be provided for service rooms (eg. electrical and communication rooms).
Standpipe and hose system	<ul style="list-style-type: none"> • In unheated area, dry standpipe system shall be provided. • Drain pipe shall be drained to sanitary system instead of dumping on the floor.
Fire Hydrant System	<ul style="list-style-type: none"> • Hydrant shall be provided as per code and include a trace line. • Fire hydrants located in a landscaped area or snowdrift area shall be raised or marked with raised identification “flag” devices. • Minimum burial depth of piping and pipe-marking/protection shall be to

	municipal requirements.
Dry Fire Suppression System	<ul style="list-style-type: none"> • Dry Fire Suppression System or clean agent system for main communication, electrical and computer and telephone equipment room shall be provided where required by Metrolinx.
Portable Fire Extinguisher	<ul style="list-style-type: none"> • Fire extinguisher shall be available during construction, and be provided as per Metrolinx for occupancy of premises.

7.4.29 Identification, Appearance, and Noise/ Vibration

7.4.29.1 Identification

- Equipment, piping, and systems shall be clearly identified according to industry standards. Equipment shall include manufacturer's nameplate, CSA, and/or CUL registration plates where applicable. Piping and ducting systems shall be identified using a standard identification system, ASHRAE, CGSB or similar.
- All labels, tags, nameplates, etc., shall be stainless steel, brass, or thick laminated plastic, as appropriate to suit application.
- Any alteration to equipment shall be approved for use by recognized certification and/or field evaluation markings.
- Refer to Metrolinx Standard 20 05 10 Basic Mechanical Materials and Methods Specification for detailed requirements.

7.4.29.2 Appearance

- All equipment, vent, access door, door grille, diffuser, return air grille, and exposed duct locations etc. shall be coordinated by the architect/prime consultant.
- Roof-mounted equipment shall be screened. Where permitted, multiple exhaust ducts shall be combined to minimize building penetration. On sloping station roofs, exhaust ducts shall be directed to vertical gable vents, if applicable.
- Exterior grade-level equipment (condensing units, etc.) shall be elevated 300 mm minimum above grade, and screened by fencing.
- Grilles, vents and diffusers shall be recessed or flush with adjoining base-building materials, as detailed by the architect/prime consultant, and shall not be surface-mounted over base-building materials.

7.4.29.3 Noise/Vibration

- Isolators and vibration control devices shall be specified as required to ensure that equipment-noise and vibration do not interfere with Metrolinx Transit operations, as well as to protect adjacent properties from noise and vibration, where necessary.
- Refer to Metrolinx Standard 20 05 10 Basic Mechanical Materials and Methods Specification for detailed requirements

7.5 Fixtures and Furnishings

7.5.1 Shelters

Because GO is primarily a commuter system, operating in accordance with timetables, most passengers arrive on platforms to coincide with train or bus departures.

Important: Sheltered areas for customer comfort integrated within the canopy on the rail or bus platform are the preference for application of the sheltered areas.

Sheltered areas should typically provide the following amenities:

- Heaters
- Digital Information Walls
- GO Standard Benches
- Wi-Fi reception
- Charging Receptacles

Fare Systems (only in certain applications at car pool lots and or remote station access locations or where there is no station building)

Where the integrated sheltered option is not available, standalone shelters shall be provided within the GO Standard suite of shelters, comprising of:

- Passenger Shelters
- Car Pool Shelters (sizing shall be determined by the Capital Projects Bus Rapid Transit Program)

The number of sheltered areas on a bus platform is determined such that each bus passenger shelter would accommodate approximately a bus-load of passengers.

The number of sheltered areas on a rail platform is determined such that each rail passenger shelter would accommodate approximately two coach-loads of passengers.

7.5.2 Digital Signs at Line Stations, Terminals and Carpool Lots

7.5.2.1 Suite of sign types

- Digital Departure Signs (Train and/or Bus)
- Digital Platform Specific Signs (Train or Bus)
- Digital Parking Counter
- Digital Way finding Interactive Kiosks(TBD)
- Infotainment

7.5.2.2 Digital Departure Signs (Train and/or Bus)

7.5.2.2.1 Location Criteria

- Digital Departure Sign (Train and/or Bus) shall be located at:
- Inside Station/Terminal buildings, adjacent to waiting area; mounted at barrier free height as per OBC and AODA regulations
- At Rail Platform Access Points (platform access area, entrances to tunnels, bridges, parking

structures, side platforms – via ramp and/or walk-on)

- At Primary Bus Loop Access Point(s)
- At Car Pool Lots shall be located at:
- At remote parking lot locations (at GO's discretion)

7.5.2.2.2 Placement & Appearance Criteria

- Information and Service Modules to be used for interior and exterior applications, with modules adjusted as required, based on site conditions (in consultation with GO)
- For exterior applications, integrate within building envelope where possible and provide weather protection i.e. building canopy
- Provide independent weather protection if integration with building canopy is not possible (in consultation with GO).
- Where an Information or Service Module cannot be established due to site conditions, consider suspending the screen from underside of canopy. At remote locations consider implementing the concept of the suite of shelters.
- At car pool lots, integrate into car pool shelter
- Where possible recess eye-level digital signs into walls to prevent potential injuries. Install such that face of screen is flush with adjacent surfaces. Ensure entire screen is visible from all angles. Conceal all conduits, connections and infrastructure

7.5.2.2.3 Monitor Size

- Use current I&IT standard

7.5.2.2.4 Number of Monitors

- Minimum one Digital Departure Sign for Train, plus one for Bus, or one combination Train and Bus Digital Sign (confirm with GO).
- For larger sites with significant service, confirm number of monitors for each of the above with GO.

7.5.2.3 Digital Platform Specific Signs (Train or Bus)

7.5.2.3.1 Location Criteria - Rail

- Island Platforms: three sets of back to back Digital Platform Specific Signs (Train) at each track used by GO.
- Side Platforms: three sets of back to back Digital Platform Specific Signs (Train) at each track used by GO.
- Avoid clustering of digital signs in close proximity; Digital Departure Sign locations take precedence over Digital Platform Specific Signs.
- Always locate one set of Digital Platform Specific Signs at mini platform and the other two equally spaced.
- Digital Platform Specific Signs should be mounted to underside of rail platform canopy.
- Ensure digital screens are outside of train envelopes.

7.5.2.3.2 Location Criteria - Bus

- At each bus platform at Line Stations, Bus Terminals and Car Pool Lots: one set of back to back Digital Platform Specific Signs (Bus).
- Locate digital signs consistently at driver end of each platform, outside of road envelope.
- Mount Digital Platform Specific Signs from underside of canopy, where possible. If not possible, use standard GO pole. Ensure poles are away from the barrier-free path of travel.

7.5.2.3.3 Placement & Appearance Criteria

- Follow GO standard drawings for poles and canopy mounts.
- At rail platforms, place static platform number on track side.
- At bus platforms, place static platform number on road side.

7.5.2.3.4 Monitor Type/Size

- LED type (Use current I&IT standard)

7.5.2.3.5 Number of Monitors

- Set of two screens, back-to-back, at each location

7.5.2.4 Digital Parking Counter

7.5.2.4.1 Location Criteria

- At vehicular entrance(s) to parking structures, visible when approaching by road

7.5.2.4.2 Appearance

- The look and feel to be integrated with GO Station ID Totem suite.

7.5.2.5 Technical Requirements

7.5.2.5.1 Process

- The digital signs will be supplied, commissioned and maintained by Information and Information Technology (I&IT), except for the Digital Parking Counter. I&IT will install the PCs, routers, and switches in the communications room
- Capital Project Delivery will perform the physical installation of the monitor, power cabling, and data cabling to the monitors from the communications rooms
- Screens and digital media players (DMP's), CPU's to be provided by IT and installed by the Contractor. Pick up from storage to be by Contractor.
- Transceivers, cabling terminations, communication room racks, and all civil work (conduits, pulling of wiring, pole footings, pole structure, mountings, NEMA boxes, etc.) to be by the Contractor.
- Fully installed and tested solution by the Contractor.
- Commissioning by the Contractor in coordination with IT and Station Operations.

7.5.2.5.2 Technical Design Requirements

- Each Digital Sign location must be shown on the electrical drawings and must include data and electrical outlet locations as well as any enclosures or other infrastructure associated with these signs
- Monitors: (Use current IT standard)

- Digital Media Player (DMP):(Use current IT standard)
- Contractor to provide transceivers/receivers, associated with cabling type and the balance of digital sign components. Provide receivers with minimal profile; by Extron or approved equivalent – reference products:
- Extron DTP HDMI 4K 330 Transmitter/ Receiver for shielded cable
- Extron HFX 100 Transmitter/Receiver for fiber
- Poles and mounting standards – refer to digital signage location criteria and requirements; GO pole conceptual design drawings under development. Shop drawings to be developed by the Contractor in coordination with digital signage equipment.

7.5.2.5.3 Connectivity

- Each of these devices requires a minimum of one CAT6 network outlet. These network outlets are to be cabled back to the nearest telecommunications room network rack and terminated as per the copper horizontal cabling standard.
- CAT6 shielded cable for devices placed within 90m from the Communications (Hub) Room.
- Multimode 6 strand fiber for installation beyond the 90m mark.

7.5.2.5.4 NEMA Enclosure

- NEMA enclosures shall be provided for receivers and fiber terminations at digital screens.
- NEMA/EEMAC Type 4X IP-65 with solid door capable to accept box lock requested by IT Field Services, and physically separated into two compartments to isolate power from communications devices.
- BEL R SS Series EEMAC/NEMA 4-4x-12 / IP-65 or Hoffman CONCEPTTM Type 4x or any other box meeting NEMA Type 4X IP-65, physical separation capabilities and box lock requirements.
- The enclosure size selection shall be based on the electrical and electronic equipment to be housed inside the box.
- All NEMA enclosures to be concealed within poles or finishes adjacent to screens. Visible NEMA boxes shall not be accepted. Provide access to concealed NEMA boxes. Do not drill or perforate the integrity of the NEMA box in any manner.

7.5.2.5.5 Conduit

- One 53mm conduit for power and separate 53mm conduit for data from the communications (hub) room all the way to the last pull point before the device; from the last pull use 25mm conduit to the device.
- Follow DRM in terms of conduit selection (PVC for buried conduit, RGSEC (Rigid Galvanized Steel Epoxy Coated at the factory) for all exposed locations such as tunnels, etc); 53mm liquid-tight conduits from the NEMA enclosure to the monitor mounting bracket. Provided with drip loops and easy release on the NEMA enclosure side.
- All conduits and connections to be concealed within poles or adjacent finishes.

7.5.2.5.6 Power

- Dedicated single 5-20R duplex receptacles shall be used
- Outdoor locations require sizing based on external enclosure and screen power draws. All receptacles must be GFI Type which may be reset at the NEMA enclosure. This is to be

coordinated at time of design and must adhere to DRM. All field assembled equipment installed in any NEMA box shall have final accredited certification as approved for use from the appropriate authority

- All devices shall be UPS backed-up. If the existing UPS does not provide enough capacity or if there is no UPS whatsoever, provide a Surge Protection Device in the local panel where the monitor and DMP is fed from. This device shall be appropriate for the specific panel at each location.

7.5.2.5.7 Data

- DMP's to be placed in Communication (Hub) Rooms.
- Assume one DMP per digital display. (confirm with IT)
- For design assumptions, use Cisco Interactive Experience Client 4650.

7.5.3 Fare Systems

Fare handling machines are proprietary equipment and will be provided and installed by the appropriate supplier. Consultants shall meet with GO Transit staff to ensure the required facilities needed to operate these machines, e.g., power, are provided.

The following equipment identified below are typical fare handling devices:

- "Interac", etc. (including data polling, Station Control Computer (SCC), Debit and Credit equipment)
- Smart Card equipment PRESTO
- Ticket Vending Machines (TVMs)

7.5.4 PRESTO Overview

Presto Fare Handling System is a smartcard-based fare payment system designed to support the use of one common fare card for fare payment on various participating public transit systems.

PRESTO equipment is proprietary, provided, and installed by the appropriate supplier, and comprises:

- SPOS (Station Point of Sale)–located on the Service Counters
- SFTP (Station Fare Transaction Processor)
- CQD (Card Query Device)
- HCR (Handheld Card Reader) and the HCR Cradles–located in Safety Systems Offices
- WAP (Wireless Access Points)–located at bus facilities
- CC (Concentrator Complex)–installed in main racks
- AVM's (Add Value Machines)

7.5.4.1 Location

Devices may be located either in the station building, on the platforms, at access points to platforms (tunnels, pedestrian bridges, walkways, stairs, ramps, etc)

7.5.4.2 General Placement Criteria

- Placement of devices and way-finding signage is site specific

- Devices shall be placed to avoid work within the Structure Clearance Envelope on/or beside Railway Track
- Bus Terminal locations require CQDs and SPOs and TVM's; all fare collecting equipment is located on the bus
- Minimum clearance of 500 mm between two adjacent devices shall be maintained.
- Devices shall not impede accessible clearances and accessible routes.

7.5.4.3 SFTP Placement Criteria

- Devices shall be placed at all rail platform access points. Devices shall be placed maximum 75 m apart at locations with direct parking lot to rail platform access.
- Devices shall be placed along passenger natural flow, at clear and visible locations, and shall be readily accessible by Cardholders for fare payment.
- Remote locations shall be provided with two (2) devices on different circuits, to provide redundancy in case of power failure.

7.5.4.4 CQD Placement Criteria

- Shall be located outside the passenger flow, near TVM and/or Information Board/Digital Station Information Signs.
- Refer to Standard Drawings for Presto System Architecture and installation details.

7.5.4.5 Ticket Vending Machines (TVM) at Line Stations, Terminals and Carpool Lots

7.5.4.5.1 Placement Philosophy:

Each Rail Line Station and GO Bus Terminal shall provide, when possible a minimum of 2 TVM at the following mandatory locations:

- 1 TVM located within the vicinity of the station building. If no station building is provided, 1 TVM will be placed at main entrance to platform (as per site conditions) along the Barrier free path of travel in such a way that the path remains barrier free
- 1 TVM to be located at an additional platform access point

Additional TVM's locations to be considered at the following pedestrian access points for the following areas within Rail Line and Bus Station sites:

- Main Bus Loop/Platform
- Parking Structure
- Pedestrian bridge, mid span, as site conditions allow
- Satellite surface parking lot
- Any additional areas as determined by GO Design Standards staff
- Park and Ride Facilities may be provided 1 TVM located on passenger platform adjacent to the shelter where power and communication infrastructure is available

7.5.4.5.2 TVM Configuration Criteria

- When site configuration allows, it is encouraged to locate TVM's that satisfy both mandatory and preferred locations. The intention is to maximize TVM accessibility and convenience to

customers with the use of a single TVM. The TVM must be visible from main entrance and located where there is a high volume of passengers. Ensure that placement does not block major egress locations

- Location of TVM to be coordinated with the location of CDQ tower, S4 Digital Information Sign, and the SFTP tower where possible
- When a cluster of all 4 devices is possible, the TVM and CQD shall be placed adjacent to each other
- A minimum 500 mm horizontal clearance is required between the CQD and the TVM
- TVM to be weather sheltered where possible
- Preference is for a shelter over the TVM
- TVM's are to utilize sunshade top (both large and smaller sized sunshades) as site conditions warrant where a full shelter is not possible
- A minimum queuing space in front of TVM shall be three customers
- Queuing space shall be increased based on historical peak station demand information provided by GO staff
- Placement and orientation of TVM's and queuing areas shall not adversely impact the main flow of customers
- TVM concrete base installation details as per GO Standard Drawings TVM-001, TVM-002 and TVM-003
- TVM Electrical and Communication details as per F.1 Electrical and F.2 Communications

7.5.5 Two Way Intercom

7.5.5.1 Design Requirements–General

The Two Way communication device is a customer service amenity, which assists customers with inquiries at rail station site to provide an enhanced customer service amenity at our platforms, elevators, parking structures, universal washrooms and maintenance facilities.

Two Way Communication Devices shall be placed at the following locations at a typical GO Rail station site:

- At each elevator lobby on site including tunnels, pedestrian bridges and parking structures (new device technology to address current technical and operational issues)
- In the vicinity of the Mini platform (to replace existing Bell telephones):
- In all universal washrooms:
- Secure entrance points for GO Operational Facilities;
- In each elevator cab;
- At each Carpool/Park and Ride site;

The Call flow shall be:

Call made to service attendant with call backup available 24/7 by Transit Safety.

Enhanced Accessibility Features include:

- Localized Hearing Loop to support tele-coil wireless technologies,
- Clear, barrier free identification using standard signage, colours and graphics in accordance with the principles outlined in the GO Transit Static Signage Catalogue, AODA and FLSA requirements.
- Refer GO Standard Specifications for detailed two way communication device requirements.

7.5.5.2 Appearance



**Elevator Cab Console
Typical Layout
(Linear Button array)**



**Elevator Cab Console
Parking Structures
(Keyboard button array)**

Figure 30: Conceptual Interior Elevator Cab Application (Diagram only)

8 Heavy Rail

For Heavy Rail, the reference should be made to the GO Transit Track Standards, and GO Transit Track Standard Plans.

9 Information technology; Telecommunication & Systems

For all IT Telecommunication and Systems requirements refer to the I&IT Standard Telecommunication and Systems document.

10 Appendix A – LEED Mandatory Credits

10.1 How to Use the GO LEED Mandatory Credit Checklist

Mandatory credits have been established for each building type to ensure that credits that are important to GO Transit's goals of energy efficiency and reduced operating and maintenance costs are targeted, integrated into the design early and achieved.

Designers are to incorporate LEED certification and the GO Transit Mandatory credits into each project's scope of work. For projects pursuing certification under LEED v.4, Gold certification is preferred, Silver certification is the minimum requirement and shall follow LEED v.4 mandatory credit tables. Projects that qualify for LEED 2009 shall attain LEED Gold certification and follow LEED 2009 mandatory credit tables. LEED has five key areas under which credits are obtained. These are:

- Sustainable Sites;
- Water Efficiency;
- Energy & Atmosphere;
- Materials & Resources and
- Indoor Environmental Quality.

Each area has Prerequisites that the project must achieve in order to consider going for LEED certification, these are non-negotiable. There is also an Innovation & Design section where innovative systems not accounted for elsewhere, exemplary performance and operational procedures can be considered for a credit. Each credit is worth anywhere from one to nineteen points, the number of points obtained determines the LEED rating achieved.

In order to achieve LEED Gold certification, anywhere between sixty (60) and seventy nine (79) points must be granted by the Canadian Green Building Council (CaGBC). It is recommended that sixty five points are targeted on each project pursuing Gold certification since the CaGBC is the final arbiter on which points are granted, so some points may be lost.

The GO LEED credit checklists that follow indicate the Prerequisites and GO Transit Mandatory credits

which must be targeted and achieved. There are additional columns indicating optional points for consideration from which the shortfall can be made, credits that are not to be pursued are also identified in the checklist.

10.2 LEED v.4 Mandatory Credits

Table 60: Appendix A – LEED v.4 Mandatory Credits for GO Stations

Mandatory	Optional	Not to be Pursued	Project Totals (pre-certification estimates): 110 Points Certified: 40-49 points Silver: 50-59 points Gold: 60-79 points Platinum: 80 points and above	Available Points
39	51	20		110
0	1	0	INTEGRATIVE PROCESS (IP)	1
0	1	0	Integrative Process	1
0	14	2	LOCATION AND TRANSPORTATION (LT)	16
0	0	16	LEED for Neighborhood Development Location	16
0	1	0	Sensitive Land Protection	1
0	2	0	High-Priority Site	2
0	5	0	Surrounding Density and Diverse Uses	5
0	5	0	Access to Quality Transit	5
0	0	1	Bicycle Facilities	1
0	0	1	Reduced Parking Footprint	1
0	1	0	Green Vehicles	1
1	9	0	SUSTAINABLE SITES (SS)	10
PREREQUISITE		Construction Activity Pollution Prevention		

0	1	0	Site Assessment	1
0	2	0	Site Development - Protect or Restore Habitat	2
0	1	0	Open Space	1
0	3	0	Rainwater Management	3
0	2	0	Heat Island Reduction	2
1*	0	0	Light Pollution Reduction	1

6	3	2	WATER EFFICIENCY (WE)	11
PREREQUISITE			Outdoor Water Use Reduction	
PREREQUISITE			Indoor Water Use Reduction	
PREREQUISITE			Building-Level Water Metering	
2	0	0	Outdoor Water Use Reduction	2
3	3	0	Indoor Water Use Reduction	6
0	0	2	Cooling Tower Water Use	2
1	0	0	Water Metering	1

* Recognition that in some situations this is not applicable. If credit not targeted, consultant to demonstrate why it cannot be achieved.

15	8	10	ENERGY & ATMOSPHERE (EA)	33
PREREQUISITE			Fundamental Commissioning and Verification	
PREREQUISITE			Minimum Energy Performance	
PREREQUISITE			Building Level Metering	
PREREQUISITE			Fundamental Refrigerant Management	
6	0	0	Enhanced Commissioning	6
7	3	8	Optimize Energy Performance	18

1	0	0	Advanced Energy Metering	1
0	0	2	Demand Response	2
0	3	0	Renewable Energy Production	3
1	0	0	Enhanced Refrigerant Management	1
0	2	0	Green Power and Carbon Offsets	2

5	3	5	MATERIALS & RESOURCES (MR)	13
PREREQUISITE			Storage & Collection of Recyclables	
PREREQUISITE			Construction and Demolition Waste Management Planning	
0	3	2	Building Life-Cycle Impact Reduction	5
1	0	1	Building Product Disclosure and Optimization - Environmental Product Declarations	2
1	0	1	Building Product Disclosure and Optimization - Sourcing of Raw Materials	2
1	0	1	Building Product Disclosure and Optimization - Material Ingredients	2
2	0	0	Construction and Demolition Waste Management	2

8	7	1	INDOOR ENVIRONMENTAL QUALITY (EQ)	16
PREREQUISITE			Minimum Indoor Air Quality Performance	
PREREQUISITE			Environmental Tobacco Smoke (ETS) Control	
0	2	0	Enhanced Indoor Air Quality Strategies	2
2	1	0	Low-Emitting Materials	3
1	0	0	Construction IAQ Management Plan	1
0	2	0	Indoor Air Quality Assessment	2

1	0	0	Thermal Comfort	1
2	0	0	Interior Lighting	2
2	0	1	Daylight	3
0	1	0	Quality Views	1
0	1	0	Acoustic Performance	1

4	2	0	INNOVATION (IN)	6
3	2	0	Innovation	5
1	0	0	LEED Accredited Professional	1

0	4	0	REGIONAL PRIORITY (RP)	4
0	4	0	Regional Priority Credit	4

Table 61: Appendix A – LEED v.4 Mandatory Credits for GO Maintenance Facilities

Mandatory	Optional	Not to be Pursued	Project Totals (pre-certification estimates): 110 Points Certified: 40-49 points Silver: 50-59 points Gold: 60-79 points Platinum: 80 points and above	Available Points
38	61	11		
0	1	0	INTEGRATIVE PROCESS (IP)	1
0	1	0	Integrative Process	1

1	15	0	LOCATION AND TRANSPORTATION (LT)	16
0	0	16	LEED for Neighborhood Development Location	16
0	1	0	Sensitive Land Protection	1
0	2	0	High-Priority Site	2

0	5	0	Surrounding Density and Diverse Uses	5
0	5	0	Access to Quality Transit	5
0	1	0	Bicycle Facilities	1
0	1	0	Reduced Parking Footprint	1
1	0	0	Green Vehicles	1

2	8	0	SUSTAINABLE SITES (SS)	10
PREREQUISITE			Construction Activity Pollution Prevention	
0	1	0	Site Assessment	1
0	2	0	Site Development - Protect or Restore Habitat	2
1	0	0	Open Space	1
0	3	0	Rainwater Management	3
0	2	0	Heat Island Reduction	2
1	0	0	Light Pollution Reduction	1

5	6	0	WATER EFFICIENCY (WE)	11
PREREQUISITE			Outdoor Water Use Reduction	
PREREQUISITE			Indoor Water Use Reduction	
PREREQUISITE			Building-Level Water Metering	
2	0	0	Outdoor Water Use Reduction	2
2	4	0	Indoor Water Use Reduction	6
0	2	0	Cooling Tower Water Use	2
1	0	0	Water Metering	1

15	15	3	ENERGY & ATMOSPHERE (EA)	33
PREREQUISITE			Fundamental Commissioning and Verification	
PREREQUISITE			Minimum Energy Performance	
PREREQUISITE			Building Level Metering	
PREREQUISITE			Fundamental Refrigerant Management	
6	0	0	Enhanced Commissioning	6
7	8	3	Optimize Energy Performance	18
1	0	0	Advanced Energy Metering	1
0	2	0	Demand Response	2
0	3	0	Renewable Energy Production	3
1	0	0	Enhanced Refrigerant Management	1
0	2	0	Green Power and Carbon Offsets	2

5	3	5	MATERIALS & RESOURCES (MR)	13
PREREQUISITE			Storage & Collection of Recyclables	
PREREQUISITE			Construction and Demolition Waste Management Planning	
0	3	2	Building Life-Cycle Impact Reduction	5
1	0	1	Building Product Disclosure and Optimization - Environmental Product Declarations	2
1	0	1	Building Product Disclosure and Optimization - Sourcing of Raw Materials	2
1	0	1	Building Product Disclosure and Optimization - Material Ingredients	2
2	0	0	Construction and Demolition Waste Management	2

6	7	3	INDOOR ENVIRONMENTAL QUALITY (EQ)	16
PREREQUISITE			Minimum Indoor Air Quality Performance	
PREREQUISITE			Environmental Tobacco Smoke (ETS) Control	
0	2	0	Enhanced Indoor Air Quality Strategies	2
2	1	0	Low-Emitting Materials	3
1	0	0	Construction IAQ Management Plan	1
0	2	0	Indoor Air Quality Assessment	2
1	0	0	Thermal Comfort	1
1	1	0	Interior Lighting	2
1	0	2	Daylight	3
0	0	1	Quality Views	1
0	1	0	Acoustic Performance	1

4	2	0	INNOVATION (IN)	6
3	2	0	Innovation	5
1	0	0	LEED Accredited Professional	1

0	4	0	REGIONAL PRIORITY (RP)	4
0	4	0	Regional Priority Credit	4

10.3 LEED 2009 Mandatory Credits

Table 62: Appendix A – LEED 2009 Mandatory Credits for GO Stations

Mandatory	Optional	Not to be Pursued	Project Totals (pre-certification estimates): 110 Points Certified: 40-49 points Silver: 50-59 points Gold: 60-79 points Platinum: 80 points and above		Available Points
47	57	8			110
7	17	2	SS	SUSTAINABLE SITES	26
PREREQUISITE			SSp1	Construction Activity Pollution Prevention	
	1		SSc1	Site Selection	1
	5		SSc2	Development Density & Community Connectivity	5
	1		SSc3	Brownfield Redevelopment	1
6			SSc4.1	Alternative Transportation, Public Transportation Access	6
		1	SSc4.2	Alternative Transportation, Bicycle Storage & Changing Rooms	1
	3		SSc4.3	Alternative Transportation, Low-Emitting & Fuel Efficient Vehicles	3
	2		SSc4.4	Alternative Transportation Parking Capacity	2
	1		SSc5.1	Site Development, Protect or Restore Habitat	1
		1	SSc5.2	Site Development, Maximize Open Space	1
	1		SSc6.1	Stormwater Design, Quantity Control	1
	1		SSc6.2	Stormwater Design, Quality Control	1
	1		SSc7.1	Heat Island Effect, Non-Roof	1
1			SSc7.2	Heat Island Effect, Roof	1
	1		SSc8	Light Pollution Reduction	1

7	3	0	WE	WATER EFFICIENCY	10
PREREQUISITE			WEp1	Water Use Reduction	
4			WEc1	Water Efficient Landscaping	4
	2		WEc2	Innovative Wastewater Technologies	2
3	1		WEc3	Water Use Reduction	4

14	17	4	EA	ENERGY & ATMOSPHERE	35
PREREQUISITE			EAp1	Fundamental Commissioning of Building Energy Systems	
PREREQUISITE			EAp2	Minimum Energy Performance	
PREREQUISITE			EAp3	Fundamental Refrigerant Management	
7	12		EAc1	Optimized Energy Performance	19
	3	4	EAc2	On-Site Renewable Energy	7
2			EAc3	Enhanced Commissioning	2
2			EAc4	Enhanced Refrigerant Management	2
3			EAc5	Measurement & Verification	3
	2		EAc6	Green Power	2

7	6	1	MR	MATERIALS & RESOURCES	14
PREREQUISITE			MRp1	Storage & Collection of Recyclables	
	3		MRc1.1	Building Reuse: Maintain Existing Walls, Floors, Roof	3
	1		MRc1.2	Building Reuse: Maintain Interior Non-Structural Elements	1
2			MRc2	Construction Waste Management	2
	2		MRc3	Materials Reuse	2

2			MRc4	Recycled Content	2
2			MRc5	Regional Materials	2
		1	MRc6	Rapidly Renewable Materials	1
1			MRc7	Certified Wood	1

8	6	1	EQ	INDOOR ENVIRONMENTAL QUALITY	15
PREREQUISITE			EQp1	Minimum Indoor Air Quality Performance	
PREREQUISITE			EQp2	Environmental Tobacco Smoke Control	
	1		EQc1	Outdoor Air Delivery Monitoring	1
		1	EQc2	Increased Ventilation	1
1			EQc3.1	Construction IAQ Management Plan, During Construction	1
	1		EQc3.2	Construction IAQ Management Plan, Before Occupancy	1
1			EQc4.1	Low Emitting Materials, Adhesives & Sealants	1
1			EQc4.2	Low Emitting Materials, Paints and Coatings	1
1			EQc4.3	Low Emitting Materials, Flooring Systems	1
1			EQc4.4	Low Emitting Materials, Composite Wood & Laminate Adhesives	1
	1		EQc5	Indoor Chemical & Pollutant Source Control	1
1			EQc6.1	Controllability of System: Lighting	1
	1		EQc6.2	Controllability of System: Thermal Comfort	1
1			EQc7.1	Thermal Comfort, Design	1
	1		EQc7.2	Thermal Comfort, Verification	1
1			EQc8.1	Daylight & Views, Daylight	1
	1		EQc8.2	Daylight & Views, Views	1

4	4	0	ID	INNOVATION & DESIGN PROCESS	6
1			IDc1.1	Innovation in Design: Green Housekeeping	1
1			IDc1.2	Innovation in Design: Solid Waste Management Policy	1
1			IDc1.3	Innovation in Design: Green Education	1
	1		IDc1.4	Innovation in Design: Low Mercury Lamps	1
	1		IDc1.5	Innovation in Design: Exemplary Performance SSc4.1 or other	1
	1			Innovation in Design: Process Water Reuse, vehicle wash (if applicable)	
	1			Innovation in Design: TBD	
1			IDc2	LEED AP	1

0	4	0	RP	REGIONAL PRIORITY	4
	1		RP1	Durable Building	1
	1		RP2.1	Regional Priority Credit 1	1
	1		RP2.2	Regional Priority Credit 2	1
	1		RP2.3	Regional Priority Credit 3	1

Table 63: Appendix A - LEED 2009 Mandatory Credits for GO Maintenance Facilities

Mandatory	Optional	Not to be Pursued	Project Totals (pre-certification estimates): 110 Points Certified: 40-49 points Silver: 50-59 points Gold: 60-79 points Platinum: 80 points and above			Available Points
47	57	8				110
8	17	1	SS	SUSTAINABLE SITES	26	
PREREQUISITE			SSp1	Construction Activity Pollution Prevention		
	1		SSc1	Site Selection	1	

	5		SSc2	Development Density & Community Connectivity	5
	1		SSc3	Brownfield Redevelopment	1
3	3		SSc4.1	Alternative Transportation, Public Transportation Access	6
1			SSc4.2	Alternative Transportation, Bicycle Storage & Changing Rooms	1
3			SSc4.3	Alternative Transportation, Low-Emitting & Fuel Efficient Vehicles	3
	2		SSc4.4	Alternative Transportation Parking Capacity	2
	1		SSc5.1	Site Development, Protect or Restore Habitat	1
		1	SSc5.2	Site Development, Maximize Open Space	1
	1		SSc6.1	Stormwater Design, Quantity Control	1
	1		SSc6.2	Stormwater Design, Quality Control	1
	1		SSc7.1	Heat Island Effect, Non-Roof	1
1			SSc7.2	Heat Island Effect, Roof	1
	1		SSc8	Light Pollution Reduction	1

7	3	0	WE	WATER EFFICIENCY	10
PREREQUISITE			WEp1	Water Use Reduction	
4			WEc1	Water Efficient Landscaping	4
	2		WEc2	Innovative Wastewater Technologies	2
3	1		WEc3	Water Use Reduction	4

14	17	4	EA	ENERGY & ATMOSPHERE	35
PREREQUISITE			EAp1	Fundamental Commissioning of Building Energy Systems	
PREREQUISITE			EAp2	Minimum Energy Performance	

PREREQUISITE			EAp3	Fundamental Refrigerant Management	
7	12		EAc1	Optimized Energy Performance	19
	3	4	EAc2	On-Site Renewable Energy	7
2			EAc3	Enhanced Commissioning	2
2			EAc4	Enhanced Refrigerant Management	2
3			EAc5	Measurement & Verification	3
	2		EAc6	Green Power	2
7	6	1	MR	MATERIALS & RESOURCES	14
PREREQUISITE			MRp1	Storage & Collection of Recyclables	
	3		MRc1.1	Building Reuse: Maintain Existing Walls, Floors, Roof	3
	1		MRc1.2	Building Reuse: Maintain Interior Non-Structural Elements	1
2			MRc2	Construction Waste Management	2
	2		MRc3	Materials Reuse	2
2			MRc4	Recycled Content	2
2			MRc5	Regional Materials	2
		1	MRc6	Rapidly Renewable Materials	1
1			MRc7	Certified Wood	1

7	6	2	EQ	INDOOR ENVIRONMENTAL QUALITY	15
PREREQUISITE			EQp1	Minimum Indoor Air Quality Performance	
PREREQUISITE			EQp2	Environmental Tobacco Smoke Control	
		1	EQc1	Outdoor Air Delivery Monitoring	1
		1	EQc2	Increased Ventilation	1

1			EQc3.1	Construction IAQ Management Plan, During Construction	1
	1		EQc3.2	Construction IAQ Management Plan, Before Occupancy	1
1			EQc4.1	Low Emitting Materials, Adhesives & Sealants	1
1			EQc4.2	Low Emitting Materials, Paints and Coatings	1
1			EQc4.3	Low Emitting Materials, Flooring Systems	1
1			EQc4.4	Low Emitting Materials, Composite Wood & Laminate Adhesives	1
	1		EQc5	Indoor Chemical & Pollutant Source Control	1
1			EQc6.1	Controllability of System: Lighting	1
	1		EQc6.2	Controllability of System: Thermal Comfort	1
	1		EQc7.1	Thermal Comfort, Design	1
	1		EQc7.2	Thermal Comfort, Verification	1
1			EQc8.1	Daylight & Views, Daylight	1
	1		EQc8.2	Daylight & Views, Views	1
4	4	0	ID	INNOVATION & DESIGN PROCESS	6
1			IDc1.1	Innovation in Design: Green Housekeeping	1
1			IDc1.2	Innovation in Design: Solid Waste Management Policy	1
1			IDc1.3	Innovation in Design: Green Education	1
	1		IDc1.4	Innovation in Design: Low Mercury Lamps	1
	1		IDc1.5	Innovation in Design: Exemplary Performance SSc4.1 or other	1
	1			Innovation in Design: Process Water Reuse, vehicle wash (if applicable)	
	1			Innovation in Design: TBD	
1			IDc2	LEED AP	1

0	4	0	RP	REGIONAL PRIORITY	4
	1		RP1	Durable Building	1
	1		RP2.1	Regional Priority Credit 1	1
	1		RP2.2	Regional Priority Credit 2	1
	1		RP2.3	Regional Priority Credit 3	1