



GO Transit Signals and Communications Standards - Signal Design Manual

RC-0506-03SIG-03

Revision 1
Date: February 2021



Signal Design Manual

RC-0506-03SIG-03

Publication Date: June 2020

Revision Date: February 2021

COPYRIGHT © 2020

Metrolinx,

an Agency of the Government of Ontario

The contents of this publication may be used solely as required for and during a project assignment from Metrolinx or for and during preparing a response to a Metrolinx procurement request. Otherwise, this publication or any part thereof shall not be reproduced, re-distributed, stored in an electronic database or transmitted in any form by any means, electronic, photocopying or otherwise, without written permission of the copyright holder. In no event shall this publication or any part thereof be sold or used for commercial purposes.

The information contained herein or otherwise provided or made available ancillary hereto is provided "as is" without warranty or guarantee of any kind as to accuracy, completeness, fitness for use, purpose, non-infringement of third party rights or any other warranty, express or implied. Metrolinx is not responsible and has no liability for any damages, losses, expenses or claims arising or purporting to arise from use of or reliance on the information contained herein.



Preface

This is the second edition of the GO Transit Signals and Communications Standards - Signal Design Manual. The second edition includes updates on the signal downgrade principles and minor changes to Table 20 and section 5.15. The document specifies the wayside Signalling System design requirements for use by design contractors carrying out the design activities for GO Transit Signal and Train Control system. It is intended for suitably qualified professionals that are familiar with the subject matter. This document is not a substitute for all applicable local codes, standards and manuals.

This document was developed by the Signals & Communications Office, Engineering and Asset Management Division, Metrolinx.

Suggestions for revision or improvements can be sent to the Metrolinx Signals and Communications office, Attention: Director of Signals and Communications. The Director of the Signals and Communications office ultimately authorizes the changes. Submitted suggestions should include a description of the proposed change, background of the application and any other useful rationale or justification. The submitter's name, company affiliation (if applicable), e-mail address, and phone number must also be included.

February 2021

Revision	Date (DD/MM/YYYY)	Description of Changes
0	20/06/2020	Initial Release
1	25/02/2021	Revised signal downgrade, local control panel & miscellaneous requirements

Contents

Prefaceiii

1. Introduction 4

 1.1 Purpose 4

2. Regulations and Standards 4

 2.1 Canadian Rail Operating Rules..... 4

 2.2 Canadian Legislation and Transport Canada 4

 2.3 Railway Safety Act..... 5

 2.4 American Railway Engineering & Maintenance of Way Association..... 5

 2.5 Grade Crossing Regulations, Standards and Guides..... 5

 2.6 Go Transit Signals & Communications Standards 5

 2.7 Canadian Electrical Code..... 6

 2.8 Union Station Rail Corridor 6

 2.9 Non-Standard Design 6

3. Document Control and Drafting Requirements 7

 3.1 Enterprise Document Record Management System (EDRMS) 7

 3.2 File Designations 7

 3.3 Drafting Requirements 10

 3.4 Design Process 14

4. General Signalling Design Principles..... 16

 4.1 General Requirements..... 16

 4.2 Closed Loop Circuit Principles 17

 4.3 Double Break Circuits..... 17

 4.4 Diodes..... 17

 4.5 External Devices 17

 4.6 Non-Vital Relays..... 17

 4.7 Track Circuits..... 17

 4.8 Signal Control 18

 4.9 Vital Circuit Power Supply Isolation 19

 4.10 Switch Machine Placement 20

 4.11 Hand Throw Switches..... 20

 4.12 Clearance Point..... 20

5. CTC Signal System 22

 5.1 Block Design 22

 5.2 Direction Naming Convention..... 28

 5.3 Track Circuit Naming 28

 5.4 Signal Naming..... 29

 5.5 Switch Naming..... 30

 5.6 Route & Aspect Charts..... 30

 5.7 Track Code Assignments..... 31

 5.8 Track Occupancy Configuration 33

 5.9 AC Power Off Indication 35

 5.10 Light Out Detection..... 35

 5.11 Signal Downgrade Due to Light Out Conditions..... 36

 5.12 Electric Locking..... 39

 5.13 Field Blocking 43

 5.14 Special Operations Requirements 46

5.15 Remote, Local, and Field Control.....	48
5.16 Flank Protection.....	50
5.17 Remote Controls and Indications.....	50
5.18 Local Controls and indications.....	52
5.19 Typical Control and Indication bits used in application software.....	57
6. Grade Crossing Warning System.....	60
6.1 General.....	60
6.2 Grade Crossing Safety Assessment.....	61
6.3 Grade Crossing Risk Assessment.....	62
6.4 Constant Warning Time Device (CWTD).....	62
6.5 Island Circuit.....	63
6.6 Adjacent Grade Crossings (DAXing or Remote Start).....	63
6.7 Ballast Resistance.....	63
6.8 Grade Crossing Warning System Circuit Design.....	63
6.9 Crossing Warning Time & Approach Calculations.....	65
6.10 Flasher.....	65
6.11 Gate Arm.....	66
6.12 Signs and Road Marking.....	66
6.13 Battery Back Up.....	66
6.14 Power Off Lights.....	66
6.15 Battery Chokes and Track Filters.....	67
6.16 Road Traffic Signals.....	67
6.17 Manual Grade Crossing Activation and Deactivation.....	67
6.18 Event Recorder.....	68
6.19 Crossing Remote Controls and Indications.....	69
7. Defect Detection System.....	70
7.1 Introduction.....	70
7.2 Railway Grade Failure Detector.....	71
7.3 High Water Alarm Detector.....	71
7.4 Wayside Inspection System.....	71
7.5 Wheel Impact Load Detector.....	72
7.6 Automatic Equipment Identification.....	72
8. Data Communications System.....	72
8.1 CTC Signal System Location.....	72
8.2 Grade Crossing Location.....	73
9. Power Service.....	73
9.1 General.....	73
9.2 Design Submittals.....	73
10. Signalling System Hardware.....	74
10.1 General Requirements.....	74
10.2 Batteries and Chargers.....	74
10.3 Vital Microprocessor Interlocking System.....	74
10.4 Local Control Panel.....	75
10.5 Wire and Cable.....	75
10.6 Surge Arrestors.....	76
10.7 Switch Machine.....	76
10.8 Switch Clearing Device (SCD).....	76
10.9 Relays.....	76
10.10 Load Center (Breaker Panel).....	76
10.11 Wayside Case.....	77

10.12	Junction Box	77
10.13	Cable Terminals.....	78
10.14	Light Emitting Diode (LED) Signal	78
10.15	Ground Fault Detector (GFD).....	78
11.	Signalling System Software	78
11.1	General Requirements.....	78
11.2	Design Requirements	79
11.3	Typical Nomenclature for Application Software	80
11.4	Design Guidelines for Key Functions	82
11.5	Code Line Configurations	86
11.6	Event Recording	86
11.7	Software Description Document	87
11.8	Configuration Management	88
11.9	Configuration Information Reporting	88
11.10	Reduced Validation.....	88
11.11	Software storage and archiving	89
12.	GTCS Changes.....	90
13.	Supervisory Control and Data Acquisition (SCADA).....	90
14.	Train Control System Interface.....	90
15.	Electrification Compatibility.....	90

1. Introduction

1.1 Purpose

- 1.1.1 This Signal Design Manual provides the design guidelines to be applied for the Signalling System in Metrolinx Territory. Signalling System includes Centralized Traffic Control (CTC) Signal System, Grade Crossing Warning System (GCWS), Defect Detection System, Data Communication System and Power Supplies. CTC Signal System includes Control Points, intermediate signals, cut sections, hand throw switches with or without electric lock.
- 1.1.2 This document is not intended as a comprehensive design specification, nor a detailed instruction manual for untrained personnel. It is intended to be used by staff and contractors who are experienced in the conceptual design, preliminary design, detailed design, installation, testing & commissioning, operation and maintenance of Signalling Systems.
- 1.1.3 Signalling System design contractors shall follow the design guidelines herein in conjunction with the standards, rules and regulations defined in Section 2 of this manual.
- 1.1.4 This Signal Design Manual will be revised in the future to accommodate new technologies that become available for deployment in Metrolinx Territory.

2. Regulations and Standards

2.1 Canadian Rail Operating Rules

- 2.1.1 Railway Operations are governed by the Canadian Rail Operating Rules (CROR) as contained within the Metrolinx Rail Corridors Operating Manual.
- 2.1.2 The Signalling System design and the functions shall not violate the Metrolinx Rail Corridors Operating Manual nor prevent train operations in accordance with the Metrolinx Rail Corridors Operating Manual.

2.2 Canadian Legislation and Transport Canada

- 2.2.1 Signalling System shall comply with the Canadian Legislative Acts and Regulations and Transport Canada (TC) federal regulations, to the extent applicable.
- 2.2.2 These standards apply to railway companies subject to the jurisdiction of the Minister of Transport pursuant to the Railway Safety Act (RSA).
- 2.2.3 Signalling System shall comply with the Railway Signal & Traffic Control System standards (2007), published by Transport Canada, to ensure that railway signal and traffic control systems are installed, modified and maintained in a safe manner. They cover the following subject matter:
 - a) Railway Signal Design Principles
 - b) General Requirements

- c) Testing and Inspection of Railway Signal and Traffic Control Systems

2.3 Railway Safety Act

- 2.3.1 Metrolinx railway systems and operations shall comply with the Railway Safety Act (RSA).
- 2.3.2 An overview of the RSA as well as a detailed copy of the act is available on the Transport Canada web site <https://laws-lois.justice.gc.ca/eng/acts/R-4.2/>.

2.4 American Railway Engineering & Maintenance of Way Association

- 2.4.1 Signalling System shall comply with the AREMA C&S Manual, unless there is a conflict with the following, which shall take precedence: federal, provincial or municipal laws and regulations.

2.5 Grade Crossing Regulations, Standards and Guides

- 2.5.1 Signalling System shall comply with the following regulations, standards and guides, that define requirements for the design, installation, testing and maintenance of the warning devices at Grade Crossings:
 - a) Grade Crossing Regulations
 - b) Grade Crossing Standards
 - c) AREMA C&S Manual Section 3 - Highway-Rail Grade Crossing Warning Systems.
 - d) Transport Canada TC E-14 Standard for LED Signal Modules at Highway/Railway Grade Crossings
 - e) Manual of Uniform Traffic Control Devices (MUTCD) for Canada
 - f) Grade Crossing Handbook
 - g) Canadian Road/Railway Grade Crossing Detailed Safety Assessment Field Guide
 - h) Guideline For Inspecting and Testing Pre-emption of Interconnected Traffic Control Signals and Railway Crossing Warning Systems TP 13755 (ISBN T33-11/2001 0-662-65823-X).

2.6 Go Transit Signals & Communications Standards

- 2.6.1 The Signalling System shall comply with the GO Transit Signals and Communications Standards, with the latest version available at http://www.gosite.ca/engineering_public/Signals%20and%20Communications%20Standards/Signals%20and%20Communications%20Standards.aspx.
- 2.6.2 Where a rule or instruction is in conflict with a law or regulation issued by a government body having jurisdiction, the law or regulation will take precedence over the rule or instruction.
- 2.6.3 The GO Transit Signals & Communications Standards comprise the following:
 - a) RC-0506-03SIG-01, Codes of Practice,

- b) RC-0506-03SIG-02, General Instructions,
 - c) RC-0506-03SIG-03, Signal Design Manual (this document),
 - d) RC-0506-03SIG-04, Signal Sighting Distance Design Standard,
 - e) Specification 34 42 01, Aluminum House Specification;
 - f) Specification 34 42 02, Wayside LED Signal Module Specification;
 - g) Specification 34 42 03, Wayside Signal Structure Specification;
 - h) Specification 34 42 04, Overhead Signal Structures Specification;
 - i) Specification 34 42 05, Hot Air Switch Clearing Device Specification.
- 2.6.4 Signalling System drawings and documentation shall comply with CPG-DGN-PLN-084 - Metrolinx CADD/BIM Standards Manual.
- 2.6.5 Signalling System shall comply with the GO Transit Track Standards, RC-0506-02TRK.
- 2.7 Canadian Electrical Code**
- 2.7.1 AC distribution equipment such as power services, isolation transformers, breaker boxes, utility plugs, bungalow lights, light switches , etc. shall be provided in compliance with Canadian Electrical Code (CEC) Part I.
- 2.7.2 Additional guidelines that are to be followed are provided in the AREMA C&S Manual Section 11.1.5 Recommended Guidelines for the Application of the National Electrical Safety Code (NES) and the National Electrical Code (NEC) to Railway Signal Facilities.
- 2.8 Union Station Rail Corridor**
- 2.8.1 The USRC project has developed a Manual of Standard Signalling Principles (MSSP), which is a compilation of the high level design concepts associated with the USRC Signalling System.
- 2.8.2 The MSSP contains an abstract level definition of each of the fundamentals of signalling controls, interlocks, rules, regulations, codes of practice and Good Industry Practice.
- 2.8.3 The MSSP shall be used as the basis of design and modification for the Signalling System deployed in the USRC.
- 2.9 Non-Standard Design**
- 2.9.1 In instances where the Signalling System must deviate from GO Transit Signals & Communications Standards or AREMA C&S Manual, the design contractor shall follow Metrolinx Standards Deviation Process.
- a) Design contractor shall produce detailed requirements for any non-standard design. The requirements shall be verified and validated throughout the project life cycle including design, installation, testing and commissioning. Any special instructions for maintenance and operations shall be clearly defined.

- b) Design contractor shall follow AREMA C&S Manual, Part 17.3.1, Recommended Safety Assurance Program for Electronic/Software Based Products Used in Safety-Critical (Vital) Applications to ensure that any design used in vital applications is safe throughout the Signalling System life cycle.

3. Document Control and Drafting Requirements

3.1 Enterprise Document Record Management System (EDRMS)

3.1.1 EDRMS is a web based system that provides an environment that Metrolinx adopts to advance projects in a consistent and efficient manner.

3.1.2 EDRMS currently supports the following activities:

- a) Storage and transfer of CAD & PDF files; application software; executive software; service bulletins, manuals, etc.;
- b) Storage and transfer of hardware configuration and asset information;
- c) Maintenance and distribution of all documentation.

3.1.3 Documents are managed by the Metrolinx Signals and Communications Office.

3.1.4 CAD files will be maintained by both the design contractor and Metrolinx.

3.2 File Designations

3.2.1 The design contractor shall comply with the Rail Corridors Document & Record Management System, RC-0701-02, which defines the various metadata fields used in Rail Corridors’ Document Register and associated file naming structures.

- a) Follow the file designations defined in this section for Signalling System documentations.

3.2.2 All documentation for the Signalling System shall be named using the following format, where the naming segments are further detailed in subsequent subsections:

- a) [Subdivision]-[Mileage]-[SIG]-[Category 1]-[Category 2]-[Category 3] -[Category 4]-[Category 5]

3.2.3 [Subdivision] shall follow Table 01 below.

Table 01: Subdivision Abbreviation

Subdivision	Abbreviation
GO	GO
Kingston	KN
Uxbridge	UX
Bala	BA
Galt	GA
Newmarket	NM
Oakville	OA

Subdivision	Abbreviation
Canpa Spur	CA
Don Branch	DB
Guelph	GU
Weston	WN
Pearson	PE

- 3.2.4 [Mileage] shall reflect the milepost of the primary signal location to the nearest 1/100th of a mile, with 5 fixed characters.
- a) e.g, for the location with milepost of 6.10, the mileage shall be 00610.
 - b) For Route and Aspect charts and Track Layout plans, both of which include a range of mileage, the boundaries of the mileage range shall be defined, such as 31610-31853.
- 3.2.5 [SIG] is the default mnemonic, used universally for Signalling System documents.
- 3.2.6 The categories defined in Tables 02 through 06 shall be followed for Signalling System documents.

Table 02: Category 1

Type	Mnemonic	Remarks
Design & Calculations	DC	
Drawings	DW	
Software	SW	

Table 03: Category 2

Type	Mnemonic	Remarks
Centralized Traffic Control (Interlocking)	CTC	
Intermediate	INT	
Grade Crossing Warning System	XING	
Route and Aspects	RA	
Track and Signal Layout	TL	
Cut Section	CS	
Electric Lock	EL	
Hand Throw Switch	HT	
Communication	COM	
Communication - Fibre Optics	FIB	
Communication - Radio Tower	RTR	
Power and Electrical	PWR	Including AC power supply to S&C System
Snow Clearing Device	SCD	
Wayside Inspection System	WIS	
High Water Detection	HWD	
Ballast Integrity Systems	BIS	
Wheel Impact Load Detector	WILD	

Table 04: Category 3 (Optional)

- a) In case this Category is not used, the file name will jump directly from Category 2 to Category 4.

Type	Mnemonic	Remarks
CAD Files	CAD	Applicable to design drawings
PDF Files	PDF	Applicable to design drawings
Southward or Eastward direction	SW or EW	Applicable to R&A Chart
Northward or Westward direction	NW or WW	Applicable to R&A Chart

Table 05: Category 4

Type	Mnemonic	Remarks
Page Number (3 digits)	001, 002, 003, etc	Applicable to design drawings

Table 06: Category 5

Type	Mnemonic	Remarks
Revision (typically 1-2 digits)	R0, R1, R2, R3, ...	Applicable to design drawings

3.2.7 File Designation Principles and Examples

- a) The circuit plan file name designates the line and the milepost location, to the nearest 100th of a mile. For example, using KN-31610-SIG-DW-CTC-CAD:
- i. the prefix "KN" designates the line, Kingston Subdivision,
 - ii. the location is at milepost 316.10, rounded to the nearest 100th which is 10,
 - iii. "SIG" designates that the file belongs to signal system,
 - iv. "DW" designates that the file is a drawing, rather than software (SW) or Design Calculations (DC),
 - v. "CTC" designates the locations as a CTC Control Point,
 - vi. "CAD" indicates that it is a CAD file. Files extensions are designated pertaining to the type of plan.
- b) All CAD files, as well as related project files, pertaining to one project and one asset shall be zipped together and uploaded to EDRMS as a single file with the same mnemonic as the PDF copy of the drawing, but with designation "-CAD" added at the end of the document number. The CAD copy will always be secured using the "confidential" feature in EDRMS.
- i. Example: KN-31610-SIG-DW-CTC-CAD, for Kingston sub, Milepost 316.10, drawing, CTC location, CAD files.
- c) Individual CAD Files
- i. Each CAD file for the location shall be given a unique name.

- ii. Example: KN-31610-SIG-DW-CTC-CAD-012-R2, for Kingston sub, Mile 316.10, CTC location, CAD file, page 12, revision 2.
- d) Software
- i. Software includes application software, programmed and compiled by the design contractor, and executive / boot software, provided by equipment suppliers. Metrolinx manages the latest version of the executive / boot software along with the supplier.
 - ii. It is the responsibility of the design contractor to incorporate the Metrolinx approved executive / boot software within the design, which shall be reflected on the Program Configuration design.
 - iii. Executive / boot software names shall not be changed.
 - iv. Application software includes vital and non-vital software, and is categorized into site specific and typical applications.
 - v. Example: KN-31610-SIG-SW-CTC-VR2 - Kingston sub, Mile 316.10, CTC location, Application software, Vital (V), revision 2.
 - vi. Example: KN-31610-SIG-SW-CTC-C1VR2 - Kingston sub, Mile 316.10, CTC location, Application software, Chassis 1, Vital, revision 2.
 - vii. Example: KN-31610-SIG-SW-CTC-NVR2 - Kingston sub, Mile 316.10, CTC location, Application software, Non-Vital (NV), revision 2.
 - viii. Example: KN-31610-SIG-SW-INT-VR2 - Kingston sub, Mile 316.10, Intermediate Signal location, Application software, Vital, revision 2.
 - ix. Example: KN-31610-SIG-SW-INT-C2VR2 - Kingston sub, Mile 316.10, Intermediate Signal location, Application software, Vital, Chassis 2, revision 2.
- e) Design contractor shall propose and submit the file designation to Metrolinx for advance review and approval, if unable to comply with the principles defined in this section.

3.3 Drafting Requirements

3.3.1 General requirements

- a) Drawings shall conform to the Metrolinx CADD/BIM Standards Manual CPG-DGN-PLN-084.
- b) AutoCAD software shall be used to generate drawings and save them in the version format identified in the Metrolinx CADD/BIM Standards Manual CPG-DGN-PLN-084.
- c) Symbols used to show signal infrastructure on drawings shall comply with AREMA C&S Manual.
- d) Design contractor shall provide CAD files to Metrolinx for each drawing sheet, including reference files.
- e) Standard drawing size shall be printable on 11" X 17" paper.
- f) All drawing content shall be legible. Design notes shall be used as necessary but should be kept to a minimum.
- g) Plans shall include the note "Field to verify" if appropriate.

- h) Signalling System configurations and code system configurations shall be shown on the drawings for all equipment and on programming configuration sheets prior to issuing to the field.
- i) Plans and design sketches shall be oriented so that west or north is on the left, and east or south is on the right.
- j) Design drawings shall have an index page including drawing and sheet number, description, and revision column that shows the revision of each page.
- k) Design drawings shall have a revision date on each page.
- l) All circuits that are continued from one sheet to another shall reference the connecting sheet number and circuit nomenclature.
- m) Circuits shall completely show tie-ins with foreign railroads. (e.g. do not use notes such as "shown on foreign railroad plan number XXXX" without including the appropriate foreign railroad design sheets within Metrolinx design).
- n) Gauge of wires on circuit plan shall be clearly defined.
- o) Circuit plan shall show the designation of the wire to be connected, and never leave the decision to the field installation personnel.





3.3.2 Drawing Markings

- a) All markings on drawings shall clearly depict the changes to be made in the field.
- b) When circuits or equipment are removed from one page and redrawn on another, a note indicating the page number of the relocated equipment or circuit shall be added to the original page.
- c) If there is a question as to the correlation of the content of a drawing with respect to field conditions then the note "FIELD TO VERIFY" may be used.
- d) Marked drawings shall be made from, and compared to, the record copy to ensure that the marked drawing correctly depicts what is shown on the record copy.

3.3.3 Drawing Colour Convention

- a) Colours selected for layers or objects may appear differently between the AutoCAD screen and the printed copy due to various plot style tables (.ctb file extension) and printer characteristics. The plot style tables provided in this manual indicates the correct colour for the printed copy.
- b) Changes shall denote changes to be made in the field. If coloured copies are required, Red=In and Blue=Out shall be used; and Orange=In and Green=Out shall be used as the 2nd phase if there are two phases.
- c) Design contractor shall follow the colour code defined in Table 07 - Colour Table for drafting.
- d) In the case of drafting a new drawing, the entire contents of the drawing can be drawn in black with a stamp "ALL NEW" in the right bottom corner in red (AutoCAD colour 10).

Table 07: Colour Table

Description	Colour Name	AutoCAD Colour Code	Example
Additions, prior to commissioning	Red	10	
Removals, prior to commissioning	Blue	130	
Temporary additions prior to commissioning, or 2 nd project phase	Orange	30	
Temporary removals prior to commissioning, or 2 nd project phase, or future work	Green	90	
Existing or Commissioned work	Black	7	

3.3.4 Sample Title Block

- a) A description of the circuits shown on individual sheets shall be included within the title block (i.e. "Signal 123N(1W) Control Circuit").
- b) Generic descriptions such as "Equipment at..." or "Circuits at..." shall not be used.
- c) Follow the format of "DWG. NO.", "REV.", and "SHEET" in the sample. Fill the "CONTRACT NO." based on the contract number.

Figure 01: A sample of the "Title Block"

THICKSON EAST			
MILE: 11.40 SUB: GO			
SIGNAL 123N (1W) CONTROL CIRCUIT			
CONTRACT NO.	DWG. NO. GO-11.40-021	REV. 0	SHEET 021

3.3.5 Sample Reference Drawings

- a) Reference drawings referred by the design package shall be listed in the Reference Drawings column.
 - i. Note the column of Reference Drawings is not commonly used in Signalling System design.

Figure 02: A sample of the "Reference Drawings"

REFERENCE DRAWINGS	
XX-XX.XX-XX	DESCRIPTION OF THE DRAWING
DWG NO.	TITLE

3.3.6 Sample Issue Column

- a) Any formal issuance from a design contractor shall be recorded in the Issue column. The issuance stage may include Issued for Review, Issued for Tender, Issued for Construction, As Installed, etc.

Figure 03: A sample of the "Issue"

ISSUE		
1	20/10/20	ISSUED FOR CONSTRUCTION
0	20/10/16	ISSUED FOR REVIEW
NO.	DATE	ISSUED FOR

3.3.7 Sample Revisions

- a) The reason for the revision shall be recorded in the Revisions column, with the associated Revision Number.

Figure 04: A sample of the "Revisions"

REVISIONS		
1	20/10/16	REVISED TO ADDRESS REVIEW COMMENTS
REV.	DATE	

3.3.8 Cell Library

- a) Design Contractor shall use the cell library defined in the Metrolinx CADD/BIM Standards Manual (CPG-DGN-PLN-084).

3.3.9 As Installed Plan

- a) As Installed Plan includes the Marked Up As Installed Plan and the Final As Installed Plan.
- b) The Marked Up As Installed Plan is the set of Issued for Construction plans used by field personnel which documents the current field configurations / changes. Marked Up As Installed plans together with associated testing records shall be returned to the Engineer of Record (EOR) with transmittal sheet that is signed and dated following any change to equipment, circuitry, or software by the field personnel.
- c) Production of the Final As Installed Plan is the final stage in the deployment of signalling equipment. The record drawings / documentation provide the up to date configurations and are essential for maintaining a reliable and safe Signalling System.
- d) The Final As Installed Plan includes track and cable layout plan, route and aspect charts, signal layout, circuit drawings, application software, program configurations, hardware configurations, etc.
 - i. EOR shall seal and submit the Final As Installed Plan to Metrolinx (software does not need to be sealed).

- e) EOR shall review test records including Factory Acceptance Testing results, Site Acceptance Testing results, and Commissioning Test results; and review any other documentation received from field personnel for compliance with GO Transit Signals and Communications standards to ensure the commissioned Signalling System is safe and reliable for operations.
 - i. EOR shall submit a sealed letter (on company letterhead) acknowledging the completed review and listing all documents submitted as part of the Final As Installed Plan and testing records organized by location of work (mileage and subdivision) and system commissioned (e.g. crossing warning system, Control Point, intermediate, defect detection system, etc).
- f) EOR shall provide the Final As Installed Plan along with sealed letter to Metrolinx within 30 days after the changes are placed into service.
- g) Refer to GO Transit Signals & Communications Standards GI - 301 (f) Conditions of Plans for more details.

3.4 Design Process

- 3.4.1 Design contractor shall implement internal design processes and assign competent personnel to perform any design work for Metrolinx to ensure the quality of the design and ultimately the reliability, availability, maintainability, and safety of the Signalling System placed in service.
- 3.4.2 Design contractor shall provide a plan describing its internal design process and shall support audits by Metrolinx at Metrolinx's discretion.
- 3.4.3 Design contractor shall only assign design work to staff that have been approved in advance by Metrolinx.
- 3.4.4 Understanding of Work
 - a) Prior to the commencement of design revisions, the design contractor shall:
 - i. review all available Final As Installed plans,
 - ii. be familiar with the current field configuration,
 - iii. identify the core hardware to be used and provide the list to Metrolinx for approval prior to detailed design, including VMIS, crossing predictor / controller, switch machine, snow clearing device, power off light, vital relay, non vital relay, charger, battery, ethernet switch, local control panel, cell modem, recording device, gate mechanism, communication device, etc, and
 - iv. discuss with Metrolinx any questions concerning work to be performed and / or scheduling.
 - b) Design contractor shall notify Metrolinx of any conflicts with the current Final As Installed plans *that* are being used as the design baseline and develop a plan jointly with Metrolinx to resolve the conflicts.
 - c) Metrolinx will ensure the Final As Installed plans can be revised without conflict with other concurrent / outstanding projects.
 - i. If a conflict is found, the records of other concurrent / outstanding projects can be requested by design contractor.
 - ii. Metrolinx will coordinate with design contractors to resolve the conflict.

3.4.5 Checking

- a) Design contractor shall provide a qualified person, other than the person performing the design, to thoroughly check all revised and/or new designs.
 - i. This person shall have a working knowledge of Signalling Systems and all phases of Signalling System projects.
 - ii. This person shall be familiar with requirements of Transport Canada, AREMA C&S manual, and the GO Transit Signals and Communications Standards.

3.4.6 Approval

- a) Design contractor shall provide a qualified person, other than the person performing the initial design or checking, to approve all revised and/or new designs by the design contractor.
 - i. This person shall have extensive knowledge of Signalling Systems and all phases of the Signalling System project.
 - ii. This person shall be familiar with requirements of Transport Canada, AREMA C&S manual, and GO Transit Signals and Communications Standards.

3.4.7 Sealed Drawings

- a) Design contractor shall provide a licensed Professional Engineer (P.Eng.) in the province of Ontario to review and seal all revised and/or new design Issued for Construction (IFC) drawings and documentation. This person may be the same as the checker and/or approver.

3.4.8 Field Engineer

- a) Implementation contractor shall provide a Field Engineer who is a licensed Professional Engineer (P.Eng.) in the province of Ontario, to support site Engineering after the IFC phase of the project.
 - i. Field Engineer shall review and modify the IFC design when discrepancies are found in the field and agreed by Metrolinx prior to implementation.
 - ii. Field Engineer may or may not be the original design contractor staff.
 - iii. The Field Engineer may also be the EOR for the construction phase.
 - iv. Field Engineer is subject to all design requirements in this design manual.
- b) If the implementation contractor is the same entity as the design contractor, then the functions of the Field Engineer shall be conducted by the originator of the design to the extent possible.

3.4.9 Engineer of Record (EOR)

- a) EOR shall be a licensed Professional Engineer (P.Eng.) in the province of Ontario who will review the construction test records and Marked Up As Installed Plans and seal the records as Final As Installed Plans.
- b) EOR shall be familiar with requirements of Transport Canada, AREMA C&S manual, and GO Transit Signals and Communications Standards.

3.4.10 Plan Revisions

- a) Design contractor, Field Engineer and EOR shall follow the design, check, and approval process and principles defined in this document for any revisions to the original plans.
 - i. The title block of the revised drawings shall reflect the personnel who revised the design and date in the fields of "designed by/checked by/approved by".
 - ii. The original title block on the revised drawings shall be replaced with the new title block, if the original title block format is different than the title block format defined in this design manual.
- b) Revisions can be caused for numerous reasons including scope changes initiated by Metrolinx, design errors, and changes initiated by the installation / testing / commissioning personnel.
- c) Refer to GO Transit Signals & Communications Standards GI - 301 (a) - Working with Approved Plans for more details.

4. General Signalling Design Principles

4.1 General Requirements

- 4.1.1 Signalling System shall be designed using fail safe principles. System safety design shall be such that any single independent component or subsystem failure will result in a safe condition. Failures that are not independent (those failures that in turn may cause others) shall be considered in combination as a single failure and shall not cause an unsafe condition.
- 4.1.2 Signals shall be provided to govern train movements into and through a particular Interlocking and between the limits of adjacent Interlockings. Signalling System shall be arranged so that failure of any part of the Signalling System shall cause affected signals to revert to the most restrictive indications associated with current conditions.
- 4.1.3 Signalling System circuits shall ensure that the following types of component failures have a restrictive effect on equipment and signal aspect:
 - a) Two-terminal devices: open, short, partial open, or partial short.
 - b) Devices with more than two terminals: combination of opens, shorts, partial opens and/or partial shorts.
- 4.1.4 Signalling System circuits and application software shall comply with the examples and principles included in AREMA C&S Manual Section 16.
 - a) If a particular application is not covered in AREMA C&S Manual Section 16, relevant examples of circuitry that are known to be tested and in service may be used as a guide, and shall be submitted to Metrolinx for approval.
- 4.1.5 Signalling System shall be fully tested by qualified personnel that are independent from the design team in accordance with AREMA C&S Manual Section 2.4.1 and GO Transit Signals and Communications Standards.

4.2 Closed Loop Circuit Principles

- 4.2.1 The closed loop circuit principle shall be applied for Signalling System designs which affect the safety of train operation.
- 4.2.2 The closed loop principle requires any permissive state or action to be verified before the permissive state or action can be formally output by the circuit.
 - a) Furthermore, the requisite conditions shall be verified to be continuously present to maintain the permissive state or action.
- 4.2.3 The failure to perform a logical operation (including decisions), or the absence of a logical input or output, shall not cause an unsafe condition.

4.3 Double Break Circuits

- 4.3.1 Circuits not confined within a single Equipment House that affect system safety shall be interrupted by relay contacts in both the positive and negative energy feed (“double break”).

4.4 Diodes

- 4.4.1 Diodes shall not be used to separate vital circuits where their failure (opening or shorting) may cause an unsafe condition. Instead, separate relay contacts shall be used in each circuit.

4.5 External Devices

- 4.5.1 External devices such as resistors, capacitors or diodes shall not be used to lengthen the release time of a relay if the failure of such external device could cause an unsafe condition.

4.6 Non-Vital Relays

- 4.6.1 Contacts of non-vital relays shall not be used in vital circuits.

4.7 Track Circuits

- 4.7.1 The occupancy of a track circuit by a train, locomotive or car shall cause the track circuit relay or equivalent to be de-energized.
- 4.7.2 The following design principles shall be applied for vital track circuits:
 - a) Track circuits shall function in a fail-safe manner, such that no failure of any component of the track circuit will result in a hazardous condition or state;
 - b) The minimum length of a track circuit shall be 100 feet, and shall not be shorter than the minimum track circuit length recommended by the equipment supplier.
 - c) The Signalling System shall detect any shunt having resistance less than or equal to 0.06Ω located at any point within the track circuit and within the fouling section of turnouts, where applicable.

- d) The length of dead sections of the track (i.e. those sections within which a shunt is not detected) shall comply to AREMA C&S Manual and GO Transit Signals and Communications Standards. Dead sections are to be kept to a minimum to the greatest possible extent.
- e) Bonding of track circuits shall conform to the AREMA C&S Manual and GO Transit Signals & Communications Standards.
- f) DC and Coded track circuits shall be insulated from all adjoining track circuits and from all non-signalized track.
- g) Polarity staggering:
 - i. When insulated joints are used with polarity-sensitive track circuits, polarity staggering shall be maintained at the insulated joints for track circuits of the same or similar types.
 - ii. For audio frequency track circuits, train detection carrier frequency and modulation rate separation shall be maintained in accordance with the equipment supplier's recommendations.
- h) When different types of track circuits are used in proximity to one another, the design shall account for any operational and/or performance differences.
- i) Track circuits shall be wired and configured to prevent unintended runaround paths between the source of the detection signal and the receiving end of the track circuit. The only viable path between the transmit and receive ends of the track circuit shall be the running rails and associated bonding wires.
- j) Track circuits shall detect broken rail conditions for both running rails.
- k) Track circuits shall compensate for ballast leakage.
- l) Where track circuits are combined using repeaters to aggregate a block, the status of the last repeater track circuit shall be used in the signal control circuit to interpret the occupancy of the block.
- m) Fast-release biased-neutral track relays shall be used with DC track circuits. Track relays and repeaters are to be mounted at eye level whenever possible for convenience of testing.
- n) Multiple-relay fouling circuits shall be used for Over Switch (OS) track circuits on turnouts with power operated switches in accordance with GO Transit Signals & Communications Standards SCP 11 - Bonding and Fouling Turnouts.

4.8 Signal Control

- 4.8.1 Signals shall be interconnected such that proceed aspects cannot be displayed simultaneously for conflicting movements, except that opposing signals may display an aspect indicating "proceed at restricted speed" at the same time on a track dedicated for switching movements by a single train.
- 4.8.2 Signalling System circuits shall be designed such that each signal governing train movements into a block will display its most restrictive aspect when any of the following conditions are present in the block:
 - a) occupancy by a train, locomotive or car (unless for following move, return to train or switching operations);

- b) switch points are not locked in the correct position as specified for the route;
 - c) an independently operated fouling-point derail equipped with a switch circuit controller is not in the derailing state;
 - d) any track relay associated with the signal is in the de-energized position or a device which functions as a track relay is in its most restrictive state; or
 - e) when the associated signal control circuit is de-energized.
- 4.8.3 Signals at adjacent Control Point shall be interconnected such that aspects to proceed on signaled track cannot be displayed simultaneously for opposing movements.
- 4.8.4 The signal control network (also known as the home network) shall provide the primary circuits for controlling signal aspects which shall include a check of the following critical functions required to display permissive signal aspects:
- a) Track switch points are lined and locked in proper position for the route. This includes all switches in a route and any switches that are not directly in a route but may affect or be affected by other conditions such as maintaining parallel routes or precluding conflicting routes.
 - b) The opposing route check is not initiated or established, and opposing route locking (if route locking is employed) is not in effect.
 - c) Time locking is not active (time is not running) on opposing signals.
 - d) Track circuits in the route are not de-energized, except where Call-on, Return to Train or switching operations allow Restricting aspects to be displayed into occupied tracks.
 - e) Track circuits that foul the route are not occupied, unless switch conditions (such switch shall be locked by route) prevent the fouled track circuits from affecting the route.
 - f) The conditions at the exiting end of the route (the block beyond the last opposing signal or up to the next signal in the same direction) are valid (route locking is effective in the direction of travel, block conditions ahead are favorable) and field track (exit) blocking is not established.
 - g) For tracks signaled for bi-directional travel (tumbledown has been initiated and/or traffic is set for the direction of travel), the direction of traffic shall be set and traffic locking shall be applied for the exiting end of the route.

4.9 Vital Circuit Power Supply Isolation

- 4.9.1 The power source or operating battery bank for vital circuits shall be electrically isolated from power sources for non-vital circuits.
- 4.9.2 Vital circuits shall be designed using fail safe principles, utilizing equipment, including printed circuit boards (PCBs), terminals, insulated wire, and wiring methods that are specifically designed for vital applications.
- 4.9.3 The dielectric strength of equipment shall comply with AREMA C&S Manual Section 11.5.1.

- 4.9.4 The following two methods are acceptable to separate vital and non-vital power supplies:
- a) The Isolation method preferred by Metrolinx for new installations or modifications to existing Signalling System equipment is:
 - i. a DC/DC converter with an input to output, input to ground, and output to ground isolation rating of either 2000 Vrms for electronic circuits or 3000 Vrms for relay logic circuit applications, in accordance with AREMA C&S Manual Part 11.5.1.
 - b) An alternative method that may be retained for existing non-vital circuits at an existing location, but shall not be introduced for a new location or a location to be re-signalled, is to use independent battery banks and chargers.

4.10 **Switch Machine Placement**

4.10.1 Switch machines shall be installed outside of the tracks wherever practicable.

4.11 **Hand Throw Switches**

4.11.1 Hand-Operated Switches (aka Hand throw switches), with or without Electric Locks, shall not be installed within interlocking limits or Control Points.

4.12 **Clearance Point**

4.12.1 The Clearance Point is defined in SCP 1 - "Location of Insulated Joints" at the point where there is 13' 6" between track centers.

4.12.2 The effective insulated joint shall be a minimum of 16' (car overhang) beyond the Clearance Point.

- a) For location deployed with sectional release function, sometime it is necessary to install the insulated joint fouling the turnout, and the following requirements shall be followed.
- b) Electric locking shall be so designed that occupancy of any track circuit fouling the turnout must electrically lock the switch until such track circuits and the over switch track circuit are vacant, and route locking / traffic locking are released.
- c) IJ fouling the turnout shall be drawn with half circle at the direction fouling the turnout in both R&A and track and signal plan. For example, if insulated joint fouls turnout on right side, half circle shall be drawn on the right side of insulated joint, with arrow pointing to right side. If insulated joint fouls turnouts on both sides, a full circle shall be drawn around the insulated joint, with arrow pointing to both sides. Fouling conditions shall be clearly noted on the plan.

4.12.3 Tables 08 through 13 are provided for guidance while determining the clearance point distance on No. 10, No. 12 and No. 20 turnouts.

4.12.4 Design contractor shall calculate the actual distance based on the track and switch design for the specific project, along with any other project-specific requirements.

- a) Refer to the associated drawings in the GO Transit Track Standards for details of the calculations.

- b) Table heading meanings are as follows:
- i. Lead means distance between Point of Switch (PS) and 1/2" Point of Frog (PF)
 - ii. X means distance between 1/2" PF and Beginning of Curve (BC)
 - iii. BC to EC means distance between BC and End of Curve (EC)
 - iv. PS to EC means the distance between PS and EC

Table 08: No.10 Turnout with Fixed Frog

Track Center	Lead	X	BC to EC	PS to EC
13' 0"	81' 6 1/2"	42' 3 1/8"	80' 3 3/8"	204' 1.0"
13' 6"	81' 6 1/2"	47' 2 7/8"	80' 3 3/8"	209' 3/4"
14' 0"	81' 6 1/2"	52' 2 3/4"	80' 3 3/8"	214' 5/8"
14' 6"	81' 6 1/2"	57' 2 5/8"	80' 3 3/8"	219' 1/2"
15' 0"	81' 6 1/2"	62' 2 1/2"	80' 3 3/8"	224' 3/8"
16' 0"	81' 6 1/2"	72' 2 1/8"	80' 3 3/8"	234' 0.0"

Table 09: No.12 Turnout with Fixed Frog

Track Center	Lead	X	BC to EC	PS to EC
13' 0"	98' 1.0"	49' 3 3/8"	99' 3.0"	246' 7 3/8"
13' 6"	98' 1.0"	55' 3 1/4"	99' 3.0"	252' 7 1/4"
14' 0"	98' 1.0"	61' 3 1/8"	99' 3.0"	258' 7 1/8"
14' 6"	98' 1.0"	67' 3.0"	99' 3.0"	264' 7.0"
15' 0"	98' 1.0"	73' 2 7/8"	99' 3.0"	270' 6 7/8"
16' 0"	98' 1.0"	85' 2 5/8"	99' 3.0"	282' 6 5/6"

Table 10: No.20 Turnout with Fixed Frog

Track Center	Lead	X	BC to EC	PS to EC
13' 0"	156' 1/2"	79' 10 1/4"	170' 2 1/4"	406' 1.0"
13' 6"	156' 1/2"	89' 10 1/4"	170' 2 1/4"	416' 1.0"
14' 0"	156' 1/2"	99' 10 1/8"	170' 2 1/4"	426' 7/8"
14' 6"	156' 1/2"	109' 10 1/8"	170' 2 1/4"	436' 7/8"
15' 0"	156' 1/2"	119' 10.0"	170' 2 1/4"	446' 3/4"
16' 0"	156' 1/2"	139' 9 7/8"	170' 2 1/4"	466' 5/8"

Table 11: No.10 Crossover with Moveable Frog

Track Center	Lead	Between 1/2" Frog Points	PS to EC
13' 0"	81' 6 1/2"	34' 8 1/8"	197' 9 1/8"
13' 6"	81' 6 1/2"	39' 8"	202' 9"
14' 0"	81' 6 1/2"	44' 7 7/8"	207' 8 7/8"
14' 6"	81' 6 1/2"	49' 7 5/8"	212' 8 5/8"
15' 0"	81' 6 1/2"	54' 7 1/2"	217' 8 1/2"
16' 0"	81' 6 1/2"	64' 7 1/4"	227' 8 1/4"

Table 12: No.12 Crossover with Moveable Frog

Track Center	Lead	Between ½" Frog Points	PS to EC
13' 0"	98' 1.0"	41' 8 3/4"	237' 10 3/4"
13' 6"	98' 1.0"	47' 8 5/8"	243' 10 5/8"
14' 0"	98' 1.0"	53' 8 1/2"	249' 10 1/2"
14' 6"	98' 1.0"	59' 8 3/8"	255' 10 3/8"
15' 0"	98' 1.0"	65' 8 1/4"	261' 10 1/4"
16' 0"	98' 1.0"	77' 8"	273' 10"

Table 13: No.20 Crossover with Moveable Frog

Track Center	Lead	Between ½" Frog Points	PS to EC
13' 0"	156' 1/2"	69' 10"	381' 11"
13' 6"	156' 1/2"	79' 10"	391' 11"
14' 0"	156' 1/2"	89' 9 7/8"	401' 10 7/8"
14' 6"	156' 1/2"	99' 9 7/8"	411' 10 7/8"
15' 0"	156' 1/2"	109' 9 3/4"	421' 10 3/4"
16' 0"	156' 1/2"	129' 9 5/8"	441' 10 5/8"

5. CTC Signal System

5.1 Block Design

5.1.1 General Requirements

- a) This section defines the block design principles.
- b) Design contractor shall refer to the contract requirements for the definition of roles and responsibilities relating to block design.
- c) Signal block design subdivides a territory into blocks, the occupancy or vacancy of which is used by Interlocking Controllers and Intermediate Signal Controllers to activate Fixed Signals so as to ensure safe train separation and to protect movements over powered track switches and derails.
- d) Signal spacing and/or signal aspects shall be based on the appropriate braking curves information for the applicable:
 - i. Worst case train consist,
 - ii. Highest train speed and
 - iii. Smallest (including largest negative) track gradient in the vicinity of the signal.
- e) In case of longer distances to the next interlocking and/or long block distances, Intermediate Signals, controlled by Intermediate Signal Controllers, may be introduced to subdivide large blocks, as required to improve the headway.
 - i. Where two-block braking is not feasible due to physical limitations, approach signals shall be placed at the worst case braking distance from the home signals.

- ii. This will allow movements into the block between Control Points at speed, but will still allow trains to come to a stop or reduced to the speed for diverging movement safely at the home signal without introducing a permanent slow order.
- f) To maximize train throughput, back to back Intermediate Signals may be provided, spaced at the braking distance for bi-directional operation and following moves in the block.
- g) Train movement/operation simulations shall be conducted to evaluate the effectiveness of the proposed block layout.

5.1.2 Sightline Distance

- a) Signal locations shall be selected to provide adequate sight distance for the Driving Crew of a train approaching the signal to clearly see and interpret the aspect displayed before they have to safely react to it.
- b) Signal locations shall comply with GO Transit Signals and Communications Standards - Signal Sighting Distance Design Standards, RC-0506-03SIG-04.

5.1.3 Signal Spacing

- a) Signals shall be spaced in accordance with the Maximum Authorized Speed and any Permanent Slow Orders (PSOs) specified in the Timetable, Special Instructions and Bulletins.
 - i. Recent and imminent changes in the Maximum Authorized Speed and PSOs must be identified and considered when determining signal spacing.
- b) Temporary Slow Orders (TSOs) are not to be used in calculating stopping distance and signal spacing, due to their transient nature.
- c) Each signal shall be located sufficiently in advance of the next signal or signals which control train movements in the same direction to enable a Driving Crew of a train to comply with a more restrictive signal through brake application, other than an emergency application, initiated at such signal.
- d) Each PSO shall be reviewed for possible elimination or adjustment. The adjustment of speed restrictions should consider the following:
 - i. A preference for uniform speeds,
 - ii. Typical actual train speeds due to grades, curves, operating patterns, equipment restrictions and
 - iii. Grade crossing locations and warning system approach distances and times.
- e) In cases where an approach aspect is not repeated, signals shall be spaced with constraints as follows:
 - i. Double block braking is preferred in the block design.
 - ii. Advanced Clear to Stop aspect shall be designed regardless of whether single block has sufficient braking distance or not.
 - iii. Aspects indicating speed reductions shall be designed in progression of Advanced Clear to Limited / Medium / Slow.

5.1.4 Braking Distance

- a) Trains of various braking characteristics operate at various speeds in Metrolinx Territory.
- b) Braking characteristics of all train types shall be considered when locating signals and determining aspects to be used.
- c) The following types of trains shall be considered to provide a worst case scenario for stopping distances and speed reduction distances:
 - i. GO Transit Passenger Trains
 - ii. Union-Pearson Express (UPE) Trains
 - iii. VIA Passenger Trains
 - iv. Other Passenger (e.g. Amtrak) Trains
 - v. CN & CP freight Trains (Refer to Time Table for freight train categories)
- d) The following speeds are used as the basis for determining stopping/speed reduction profiles:
 - i. Clear Speed = Track Speed
 - ii. Diverging Speed = a speed not exceeding 25 MPH
 - iii. Limited Speed = a speed not exceeding 45 MPH
 - iv. Medium Speed = a speed not exceeding 30 MPH
 - v. Slow Speed = a speed not exceeding 15 MPH
 - vi. Restricting Speed = a speed not exceeding 15 MPH
 - vii. Stop

5.1.5 Maximum speeds for divergent moves of different train types:

- a) #20 Turnout = 45 MPH for all train types
- b) #16 Turnout = 30 MPH for all train types
- c) #12 Special Turnout (all welded) = 25 MPH for all train types
- d) #12 Regular Turnout and any turnout size below #12 = 15 MPH for all train types
- e) Double Slip Switch at USRC = 30 MPH for GO Transit trains;
 = 25 MPH for VIA and other non-GO Transit passenger trains (timetable speed);
 = 15 MPH for freight trains.

5.1.6 The stopping profiles used to calculate block length at a given location vary based on authorized block entry speed ("Clear Speed," 45MPH, 30MPH, 25MPH and 15MPH) to a Stop.

5.1.7 The speed reduction profiles used to calculate block length at a given location vary based on authorized block entry and exit speed combinations as follows:

- a) Clear Speed to 45MPH
- b) Clear Speed to 30MPH
- c) Clear Speed to 25MPH

- d) Clear Speed to 15MPH
- e) 45MPH to 30MPH
- f) 45MPH to 25MPH
- g) 45MPH to 15MPH
- h) 30MPH to 15MPH

5.1.8 Average Grade

- a) The braking distance calculations for each type of freight or passenger train shall be evaluated over computed average gradients to determine the actual “worst-case” braking distance to be used for speed reductions.
- b) Average gradients are determined by calculating the following three scenarios and selecting the worst case (lowest positive gradient or steepest negative gradient):
 - i. Gradient A: Signal to Signal in the block of interest
 - ii. Gradient B: Signal to Signal + SHORT train length (1000 feet for passenger trains; 6000 feet for freight trains)
 - iii. Gradient C: Signal to Signal + LONG train length (2000 feet for passenger trains; 12,000 feet for freight trains)
- c) Calculation for average gradient - basic equation
 - i. The average gradient is calculated by taking the arithmetic mean of individual grade elements over the region being evaluated as shown in example below.

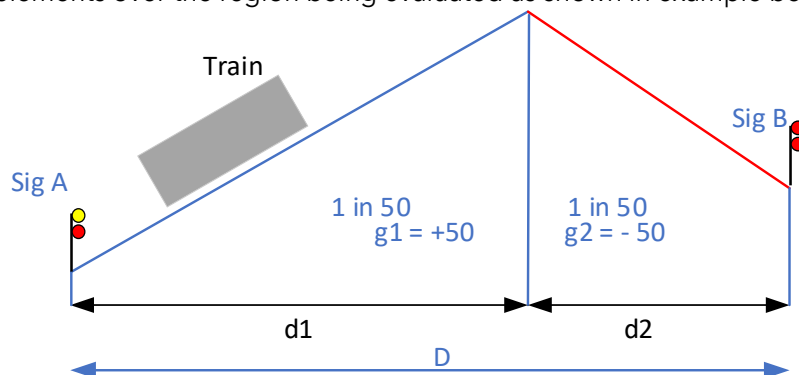

$$\frac{G_{average\ Gradient}}{D} = 1 / \left(\frac{d1}{g1} + \frac{d2}{g2} \right)$$

$$G_{average\ Gradient} = D / \left(\frac{d1}{g1} + \frac{d2}{g2} \right)$$

- ii. Where $G_{average\ Gradient}$ is the average gradient and D is the total distance over the region being evaluated.
- d) Calculation for average gradient - Sample

- i. Assuming the following parameters for a sample calculation using the above equation to compute average gradient: signal-to-signal block length of 5280 feet; segment gradients of 1 in 50 feet, 1 in 143 feet, 1 in 50 feet and 1 in 20 feet; train lengths of 6000 and 12000 feet (freight trains).
- ii. Gradient A - Signal to Signal

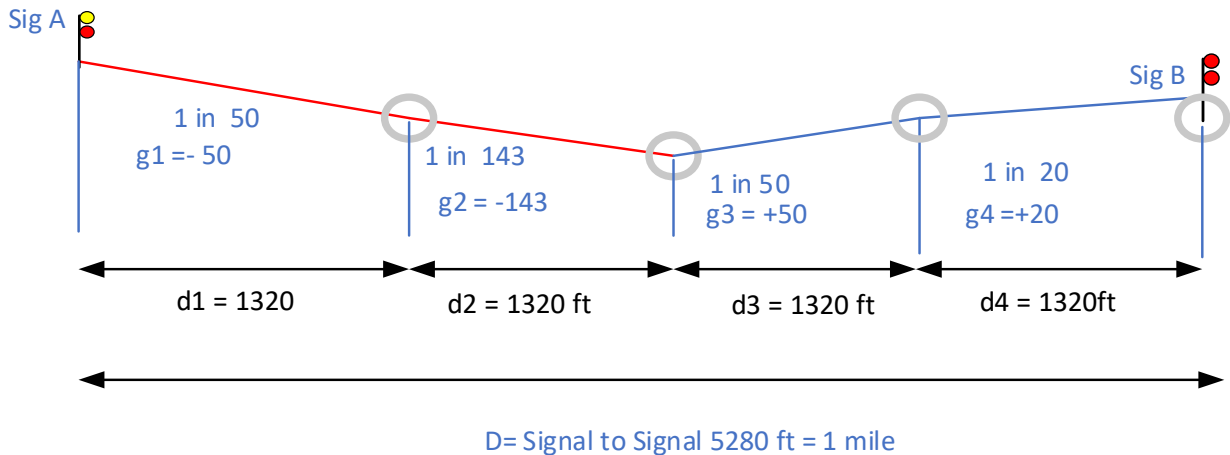

$$G_{averageGradient_1} = D / \left(\frac{d1}{g1} + \frac{d2}{g2} + \frac{d3}{g3} + \frac{d4}{g4} \right)$$

$$G_{averageGradient_1} = 5280 / \left(-\frac{1320}{50} - \frac{1320}{143} + \frac{1320}{50} + \frac{1320}{20} \right)$$

= +93.01 or 1% grade, or 1 feet of vertical change for every 93.01 feet of horizontal distance.

$$G_{averageGradient_1\%} = + (1/93.01) \times 100 = +1.075\%$$

- iii. Gradient B - Signal to Signal and Short Train

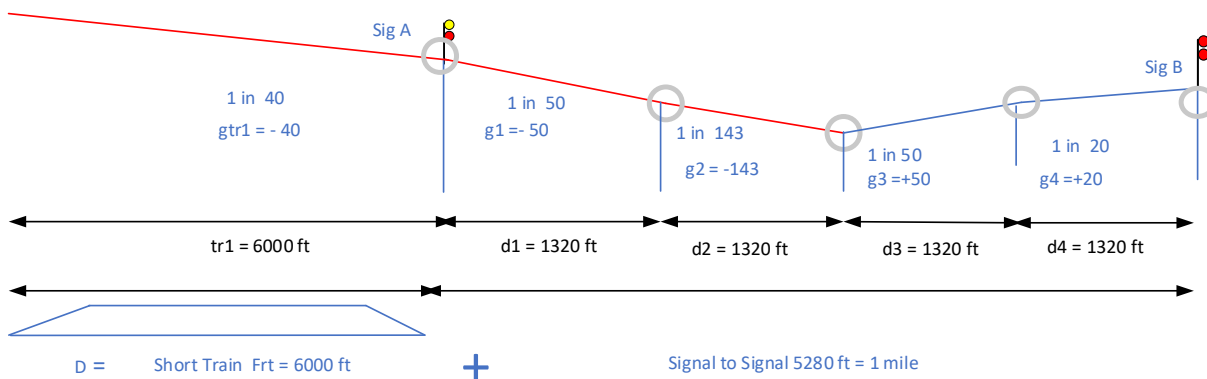

$$G_{averageGradient_2} = D / \left(\frac{d1}{g1} + \frac{d2}{g2} + \frac{d3}{g3} + \frac{d4}{g4} + \frac{tr1}{gtr1} \right)$$

$$G_{averageGradient_2} = (5280 + 6000) / \left(-\frac{1320}{50} - \frac{1320}{143} + \frac{1320}{50} + \frac{1320}{20} - \frac{6000}{40} \right)$$

= - 120.93, or 1 feet of vertical change for every 120.93 feet of horizontal distance.

$$G_{averageGradient_2}\% = -(1/120.93) \times 100 = -0.82\%$$

iv. Gradient C - Signal to Signal and Long Train

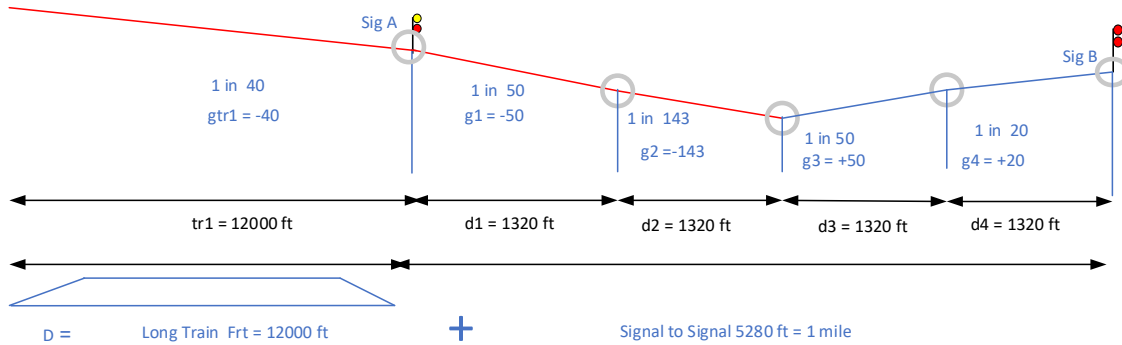

$$G_{averageGradient_3} = D / \left(\frac{d1}{g1} + \frac{d2}{g2} + \frac{d3}{g3} + \frac{d4}{g4} + \frac{tr1}{gtr1} \right)$$

$$G_{averageGradient_3} =$$

$$(5280 + 12000) / \left(-\frac{1320}{50} - \frac{1320}{143} + \frac{1320}{50} + \frac{1320}{20} - \frac{12000}{40} \right)$$

= - 71.04 or 1 feet of vertical change for every 71.04 feet of horizontal distance.

$$G_{averageGradient_3}\% = -(1/71.04) \times 100 = -1.4\%$$

- v. Determine worst case average gradient by taking the lowest value of the gradients obtained in the above three examples.

$$Gradient\%_{worstcase} = \text{Lowest Value } (G_{averageGradient_1}\%, G_{averageGradient_2}\%, G_{averageGradient_3}\%)$$

$$Gradient\%_{worstcase} = \text{Lowest Value } (+1.075\%, -0.82\%, -1.4\%)$$

$$Gradient\%_{worstcase} = -1.4\%$$

5.1.9 To further increase the margin of safety, the following additional margin factor shall be added to the overall stopping distance curves when performing signal block design:

- a) Some of the stopping curves referenced in this document incorporate the 20% margin factor while others do not.
- b) For those identified as not having a margin factor built into the stopping curves, an additional margin of 20% shall be added when braking distance curves are referenced:
- c) Metrolinx GO Train braking curves incorporate the margin factor of 20% of the calculated stopping distance.

- d) CN "Freight and Passenger Braking Curves" do NOT include the 20% margin factor, so they must have the margin added.
- e) CN "Development of GO Transit Passenger Train Stopping Distances" includes a variable margin factor PLUS an added fixed length and do not need to have additional distance added to the stopping distances derived from the graphs.
- f) VIA "Braking Stopping Distance Look Up Tables" do NOT include the 20% margin factor, so they must have the margin added.

5.1.10 Freight trains and non-GO Transit passenger trains that require longer braking distances than GO Transit trains are required to operate at lower speeds, which are determined during the simulation process and included in the applicable Subdivision's timetable.

5.2 Direction Naming Convention

5.2.1 The direction naming convention shall utilize:

- a) West for Northward or Westward movements, and
- b) East for Southward or Eastward movements

5.3 Track Circuit Naming

5.3.1 For OS track circuits within an interlocking or Control Point, the track circuit name shall relate to the designation number of the track associated with the track circuit followed by the letter "T"; for example:

- a) the north or east track is designated as track 1 (single track is designated as track 1),
- b) the west or south track is designated as track 2,
- c) for more than 2 tracks, use the corresponding track number such as track 3, etc.

5.3.2 Subsequent track circuits on a track shall be designated with a consecutive letter starting with "A" before the "T", for example:

- a) the next track circuit within the interlocking is designated "1AT",
- b) the next subsequent track circuit is designated "1BT", etc.,
- c) at an end-of-siding location OS track circuit is designated "OST".

5.3.3 For the bidirectional track circuit between 2 intermediate signals in Coded Track Circuit territory, the name shall relate to the track name and what directional side of the insulated joints the circuit is on followed by the letter "T":

- a) for example, for track 1, west side of the insulated joints, the name is 1WT.

5.3.4 For a Coded Track Circuit adjacent to the Control Point, the same naming convention is applied, such as 1WT, for the Coded Track Circuit, on west side of the insulated joints for signal 1E.

- 5.3.5 For a Coded Track Circuit at an end-of siding location:
- FPT shall be used for track circuit at facing point side,
 - for the track circuit on straight track at trailing point side, TPMT shall be used,
 - for track circuit on diverging track at trailing point side, TPST shall be used.
- 5.3.6 For the Island track circuit at a Grade Crossing, the track circuit name shall relate to the designated number of the track associated with the track circuit and a "X" with a "T" suffix, for example:
- north track or east track , which is track 1, shall be designated 1XT,
 - west or south track, which is track 2, shall be designated 2XT,
 - for more than 2 tracks use the corresponding track number such as track 3XT etc.,
 - for a single track it is acceptable to use XT.
- 5.3.7 For signal blocks with multiple track circuits in a relay based system, the track circuit name shall relate to the number of the southbound or eastbound signal entering the block with the track circuit name followed by the letter "T", for example:
- the first track circuit related to Signal 3168N shall be "3168NT",
 - subsequent track circuits shall have a consecutive letter starting with the letter "A" before the "T",
 - the next track circuit after 3168NT will be called "3168NAT", the next subsequent track circuit "3168NBT", and so on.

5.4 Signal Naming

- 5.4.1 Signals shall designated by their associated track mileage to approximately the nearest tenth of a mile. Southbound or eastbound signals shall be designated using even numbers, and northbound or westbound signals are designated using odd numbers. The number shall be a minimum of 3 digits and prefixed with "0" if the mileage is less than 10.
- On multi-track (more than 2 tracks), the designated track name shall be suffixed to the signal number, e.g. 331T1, 331T2, etc.
 - On double track, the track orientation shall be suffixed to the signal number, e.g. 331N, 331S.
 - On single track for a signal located on the trailing point at an end-of-siding location, "S" or "N" shall be suffixed to the signal number, e.g. 331S for a signal located on south track.
 - Low mast ("dwarf") signals shall be suffixed with "D", e.g. 331D.
- 5.4.2 Signal names shall be consistent in usage among Local Control Panels, design sketches, circuit nomenclature, house wire tagging, software nomenclature, and Route and Aspect charts.

5.4.3 In order to simplify and standardize the application software, the signal nomenclature shall be designated by track number and direction shown in parenthesis. This will allow for standard wiring, tagging procedures and simplifying software production.

- a) For example, for 331T1(1W). 1W shall be used in application software.
 - i. In double track situation, "1" shall be associated with north track, "2" shall be associated with south track, e.g. 331S(2W).
 - ii. In single track situation for back to back controlled signals, "1" shall be associated with the direction of "W" or "E", e.g. 331(1W).
- b) At an end-of-siding location:
 - i. FP shall be used for facing point signal, e.g., 331(FP), for signal located on the facing point side,
 - ii. TPM shall be used for signal located on straight track at trailing point side, for example, 332S(TPM),
 - iii. TPS shall be used for signal located on diverging track at trailing point side, for example, 331N(TPS).

5.5 Switch Naming

5.5.1 The convention for naming switches shall be:

- a) Power Switches: assign the switch an odd number (even numbers are not used) starting from one, increasing from left to right (e.g. 1, 3, 5). For crossovers, assign the same number suffixed with letter "A" and "B" (e.g. 1A, 1B), where A is the west or north end of such crossover and B is the east or south end.
- b) Hand Operated Switches: label either EL (Electric Lock) or HOS (Hand Operated Switch) depending on whether electric locks or switch circuit controllers are applied. Numbering is not required.

5.5.2 Switch names shall be consistent in usage among Local Control Panels, design sketches, circuit nomenclature, house wire tagging, software nomenclature, and R&A Charts.

5.6 Route & Aspect Charts

5.6.1 General Requirements

- a) Route & Aspect (R&A) charts shall be furnished for all new designs and for modifications to existing designs.
- b) R&A charts shall indicate the aspects for all possible routes and associated signals.
- c) Each route shall be carried back to the first Clear aspect, including routes to and from foreign railway connections.
- d) The R&A charts contain information that is the basis of the design of the Signalling System.

5.6.2 R&A charts shall contain the following:

- a) Single line track configuration (not to scale) on a standard drawing frame, complete with signals identified by name;
- b) All track circuits, power switches, electric locks, hand throw switches, signals, size of turnouts, and crossings;
- c) Signal aspects for each location in all directions consistent with safe operation;
- d) Coded track codes as applicable;
- e) Signal aspects (generally speed signalling type) in accordance with the CROR, or special aspects contained to the applicable railway operating timetable;
- f) A graphical depiction of routes for each aspect displayed (e.g. aspects for straight moves to be connected with straight lines, aspects for diverging routes to be connected with diverging lines for turnouts);
- g) Call on, return to train, stick circuits, and any other feature necessary to supplement operation;
- h) Potential maintenance code (Code M) associated with a device (e.g. signal);
- i) Block indication (Code 5) for 3 and more blocks applications;
- j) Any additional notes required to clarify special situations or requirements such as sectional switch releasing clearances at insulated joints.

5.7 Track Code Assignments

5.7.1 Track codes carry track, block, and signal aspect information between two wayside locations.

5.7.2 As shown in Table 14, ten track codes communicate this information, six of which represent vital information while the other four represent non-vital information.

Table 14: Code Definition

CODE	DEFINITION
1	<ul style="list-style-type: none"> • Non-vital reference code, begins each message transmission • Usually followed by other vital and non-vital codes • Verify track integrity when no other codes are being transmitted
2, 3, 4, 7, 8, 9	Vital code carrying aspect information
5	Non-vital code, indicate block occupancy
6	Non-vital code, as a tumbledown code to set opposing signals to stop
M	<ul style="list-style-type: none"> • Non-vital code, indicates power off and light out alarms for intermediate signals • Programmed for specific site requirements

5.7.3 Tables 15 and 16 define the code assignments recommended to be used for major resignalling projects, such as resignalling an entire subdivision.

- a) Terminology conventions used in these tables are as follows:
 - i. / = "Over",
 - ii. Y = Yellow,

- iii. FY = Flashing Yellow,
 - iv. G = Green,
 - v. FG = Flashing Green,
 - vi. R = Red.
- b) For modifications to existing locations, or the limited addition of locations within an existing subdivision, the code assignments are allowed to follow the existing rules in the subdivision, to ensure consistency between new (or modified) location and existing locations.

Table 15 - Code Assignment for 2 Block Braking

Code Received	Sample Aspect	CROR Description	Code transmitted	Sample Aspect	CROR Description
Not Applicable	R/R - Rule 439 R/Y - Rule 436	Rule 439 - STOP Rule 436 - Restricting (Controlled Signal) Rule 436 - Restricting, Proceed at Restricting Speed (R/R With "R" Plate on Signal With Directional Stick Established)	8	Y/R	Rule 411 - Proceed, preparing to STOP at next signal
8	Y/R	Rule 411 - Proceed, preparing to Stop at next signal	4	FY/R	Rule 415 - Advanced Clear to Stop
Varies	R/R/G	Rule 431 - Slow to Clear	9	Y/Y	Rule 409 - Clear to Slow
Varies	R/G/R	Rule 422 - Medium to Clear	2	Y/G	Rule 407 - Clear to Medium
Varies	R/FG/R	Rule 416 - Limited to Clear	3	Y/FG	Rule 406 - Clear to Limited
2	FY/G/R	Rule 413 - Advanced Clear to Medium	7	G/R	Rule 405 - Clear
3	FY/FG/R	Rule 412 - Advanced Clear to Limited	7	G/R	Rule 405 - Clear
4	FY/R	Rule 415 - Advanced Clear to Stop	7	G/R	Rule 405 - Clear
7	G/R	Rule 405 - Clear, PROCEED	7	G/R	Rule 405 - Clear

Table 16 - Code Assignment for 4 Block Braking

Code Received	Sample Aspect	CROR Description	Code transmitted	Sample Aspect	CROR Description
Not Applicable	R/R - Rule 439 R/Y - Rule 436	Rule 439 - Stop Rule 436 - Restricting (Controlled Signal) Rule 436 - Restricting, Proceed at Restricting Speed (R/R With "R" Plate on Signal With Directional Stick Established)	8	Y/R	Rule 411 - Proceed, preparing to Stop at next signal
8	Y/R	Rule 411 - Clear to Stop	4	FY/R	Rule 415 - Advanced Clear to Stop
4	FY/R	Rule 415 - Advanced Clear to Stop	2	Y/FG	Rule 406 - Clear to Limited
Varies	R/FG/R, R/FG/FG, R/FY/R	Rule 416 - Limited to Clear Rule 417 - Limited to Limited Rule 421 - Limited to Stop			
2	Y/FG	Rule 406 - Clear to Limited	3	FY/FG	Rule 412 - Advanced Clear to Limited
3	FY/FG/R FY/FG	Rule 412 - Advanced Clear to Limited	7	G/R	Rule 405 - Clear
7	G/R	Rule 405 - Clear	7	G/R	Rule 405 - Clear

5.8 Track Occupancy Configuration

- 5.8.1 Whenever practical the status of each track section shall be communicated separately to the GO Transit Train Control System (GTCS).
- 5.8.2 All track indications shall indicate to the GTCS as a 1 (or true) when occupied.
- 5.8.3 OS track indications shall be provided according to the following:
- The loss of shunt shall simultaneously remove the OS track indication and switch locking indications.
 - There shall be an indication for each OS track section.
 - Stuck searchlight mechanism conditions shall operate independent from OS indications and shall be indicated separately.
- 5.8.4 Block indications (BK) shall be designed as per the principles defined below unless otherwise approved by Metrolinx.
- BK indications shall include hand throw switches located in a block that is outside the OS track circuits. BK indications shall indicate as a 1 when the block(s) is de-energized or when a hand throw switch is not in the normal position. Block indications shall also indicate hazard detectors (WIS, BIS, High Water Detector, etc.) if they are not able to indicate separately. The following examples show Code 1 or Code 5 used for block indication to GTCS.

- b) Maintenance Code M will indicate either Remote Light Out (RLOK) or Remote Power Off (RPOK) from the Intermediate signals towards the next appropriate Control Point. These indications shall indicate to the GTCS as a 1 when displayed. RPOK shall always feed towards the Control Point in the North or West direction, RLOK shall always feed toward the Control Point in the South or East direction.
 - i. RLOK shall include light out alarms and other alarms associated with the VMIS (Vital Microprocessor Interlocking System) healthy.
 - ii. RPOK shall include power off alarms and other alarms associated with the battery healthy, charger healthy, and ground fault.
- c) One-Block Track Indication (reference Figure 05):
 - i. Code 1 shall be used for block indication,
 - ii. Code M and Code 5 are not used for this application.

Figure 05 - One-Block Track Indication

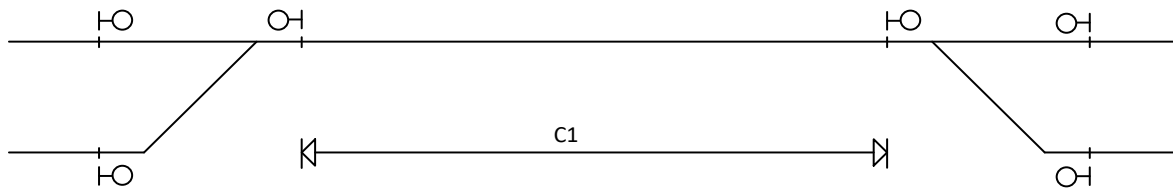

- d) Two-Block Track Indication (reference Figure 06):
 - i. Code 1 is used for block indication.
 - ii. Code M indicates RPOK or RLOK,
 - iii. Code 5 is not used for this application.

Figure 06 - Two-Block Track Indication

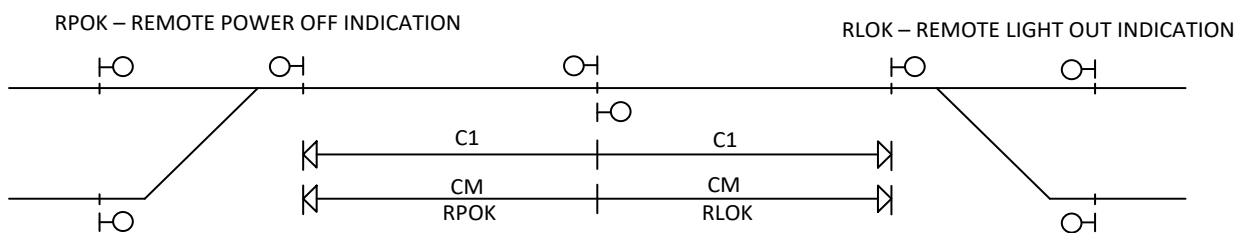

- e) Three-Block Track Indication (reference Figure 07):

- i. Code 5 is used for block indication which provides a repetition of the middle block,
- ii. Code M is used indicating RPOK or RLOK.

Figure 07 - Three-Block Track Indication

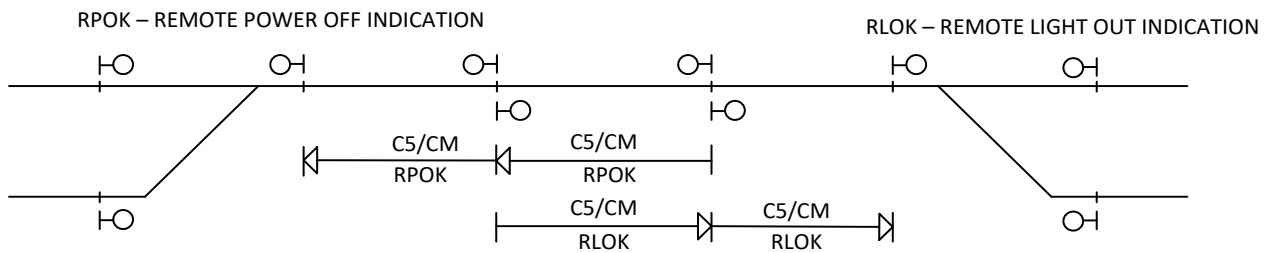

- f) Four Blocks Track Indication (reference Figure 08):
 - i. Code 5 is used for block indication without overlapping,
 - ii. Code M is used indicating RPOK or RLOK.

Figure 08 - Four-Block Track Indication

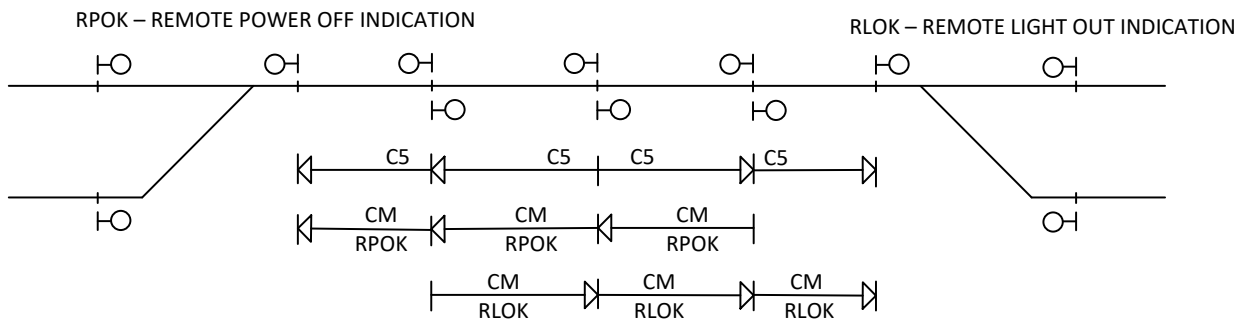

5.9 AC Power Off Indication

- 5.9.1 The AC Power Off Indication shall be provided from Control Point to both LCP and GTCS when an AC Power Off condition has occurred, battery is unhealthy, or the charger is unhealthy.
- 5.9.2 Remote AC Power Off Indication from the Intermediate signal locations via Maintenance Code M shall be provided to both the Local Control Panel (LCP) and GTCS at the respective Control Point.

5.10 Light Out Detection

- 5.10.1 Light out detection is a method of verifying if a signal is operable by monitoring the signal lighting circuit to ensure the circuit is complete (no break).
- 5.10.2 Signalling System shall downgrade the upstream signal to the appropriate signal aspect as described in section 5.11 wherever a light out condition is detected.

5.10.3 Light out indication shall be provided from Control Point to both GTCS and LCP to advise when a signal light out condition has been detected.

5.10.4 Remote Light Out Indication from the Intermediate signal locations via Maintenance Code M shall be provided to both GTCS and LCP at the Control Point.

5.11 Signal Downgrade Due to Light Out Conditions

5.11.1 In conjunction with CROR Rule 27, signal downgrade tables in this section shall be utilized for any locations outside of USRC.

5.11.2 The failure of a signal lamp in a signal shall not cause the display of a less restrictive aspect than intended per AREMA C&S Manual Part 2.1.1.

5.11.3 The principles of downgrading the signal aspects of a signal that has light out conditions are intended to be used for Colour Light Signals.

5.11.4 The signal aspect downgrades defined in Table 17 and Table 18 can only be achieved if the downgrade aspect is available under normal operations and is itself not suffering from a Light Out condition. As an example, if a Green LED is detected as out, the Yellow is detected as working, the Green aspect could be downgraded to Flashing Yellow.

a) If the downgraded aspect is a valid signal aspect and is an aspect that the signal is able to display under normal operations, the principles defined for the downgraded aspect shall be followed. As an example, if G/R is downgraded to FY/R, the principles defined for FY/R shall be applied if there is light out detected on either Yellow or Red or both.

b) If the downgraded aspect is not an aspect that the signal is able to display under normal operations, for example, if G/R is downgraded to FY/R, however FY/R is not an aspect defined in the Route and Aspect chart for the signal, then G/R shall be downgraded to Y/R, if Y/R is a valid aspect defined in the Route and Aspect chart. The contractor shall propose the solution and submit to Metrolinx for agreement and approval.

5.11.5 Unless otherwise indicated in the tables, the aspect (including aspect defined in "Aspect" column for initial downgrade, aspect defined in "Downgraded Aspect" column for further downgrade, and aspect defined in "Light Out" column without further downgrade) resulting from a light out condition shall be altered to display STOP (all signal heads to Red or Dark if Red is not available), applicable to controlled signal) or Restricting (all signal heads to be Red or Dark if Red is not available, applicable to intermediate signal) and the previous (upstream) signal will display XXX to Stop (such as Clear to Stop).

5.11.6 Colour designations, R=Red, Y=Yellow, G=Green, FY= Flashing Yellow, FG=Flashing Green, D=Dark.

5.11.7 NA=Not applicable, meaning that the signal aspect is not further downgraded.

5.11.8 Aspect (D) = low mast signal. Default aspect represents the high mast signal.

5.11.9 Code (Line Circuit) Out = Downgrade - corresponds to the aspect in the "Downgraded Aspect" column; Stop - corresponds to the Stop (controlled signal) or Restricting (intermediate signal); NC - corresponds to the aspect in the "Aspect column".

Table 17 Controlled Signal Aspect Downgrade Table

Rule	Aspect	Light Out	Downgraded Aspect	Code (Line Circuit) Out
405 - Clear	G/R/R	D/R/R	FY/R/R	Downgrade
		G/D/R, G/R/D, G/D/D	NA	Stop
	G/R	D/R	FY/R	Downgrade
		G/D	NA	Stop
406 - Clear To Limited	Y/FG/R	Y/FG/D	NA	Stop
		D/FG/R	R/R/Y (w/o DV plate)	Stop
		Y/D/R	Y/R/R	Downgrade
	Y/FG	D/FG	R/Y (w/o DV plate)	Stop
		Y/D	Y/R	Downgrade
407-Clear to Medium	Y/G/R	Y/G/D	NA	Stop
		D/G/R	R/R/Y (w/o DV plate)	Stop
		Y/D/R	Y/R/R	Downgrade
	Y/G	D/G	R/Y (w/o DV plate)	Stop
		Y/D	Y/R	Downgrade
408 - Clear to Diverging 409- Clear to Slow	Y/Y/R	Y/Y/D	NA	Stop
		D/Y/R	R/R/Y (w/o DV plate)	Stop
		Y/D/R	Y/R/R	Downgrade
	Y/Y	Y/D	Y/R	Downgrade
		D/Y	R/Y (w/o DV plate)	Stop
411- Clear to Stop	Y/R/R	Y/D/R, Y/R/D, Y/D/D	NA	Stop
		D/R/R	R/R/Y (w/o DV plate)	Stop
	Y/R	Y/D	NA	Stop
		D/R	R/Y (w/o DV plate)	Stop
412- Advanced Clear to Limited	FY/FG/R	FY/FG/D	NA	Stop
		D/FG/R	R/R/Y (w/o DV plate)	Stop
		FY/D/R	FY/R/R	Downgrade
	FY/FG	D/FG	R/Y (w/o DV plate)	Stop
		FY/D	FY/R	Downgrade
413- Advanced Clear to Medium	FY/G/R	FY/D/R	FY/R/R	Downgrade
		D/G/R	R/R/Y (w/o DV plate)	Stop
		FY/G/D	NA	Stop
	FY/G	FY/D	FY/R	Downgrade
		D/G	R/Y (w/o DV plate)	Stop
414- Advanced Clear to Slow 414a - Advanced Clear to Diverging	FY/Y/R	FY/Y/D	NA	Stop
		D/Y/R	R/R/Y (w/o DV plate)	Stop
		FY/D/R	FY/R/R	Downgrade
	FY/Y	FY/D	FY/R	Downgrade
		D/Y	R/Y (w/o DV plate)	Stop
415- Advanced Clear to Stop	FY/R/R	FY/D/R, FY/R/D, FY/D/D	NA	Stop
		D/R/R	R/R/Y (w/o DV plate)	Stop
	FY/R	FY/D	NA	Stop
		D/R	R/Y (w/o DV plate)	Stop
416- Limited to Clear	R/FG/R	R/D/R	R/FY/R	NC
		D/FG/R	D/R/Y	Stop

Rule	Aspect	Light Out	Downgraded Aspect	Code (Line Circuit) Out
		R/FG/D	NA	Stop
	FG/R(D)	D/R	FY/R	NC
		FG/D	NA	Stop
417- Limited to Limited	R/FG/FG	R/FG/D	R/FY/R	NC
		D/FG/FG	D/R/Y	Stop
		R/D/FG	R/FY/R	NC
418 - Limited to Medium	R/FG/G	R/FG/D	R/FY/R	NC
		D/FG/G	D/R/Y	Stop
		R/D/G	R/FY/R	NC
419 - Limited to Slow 419a - Limited to Diverging	R/FG/FY	R/FG/D	R/FY/R	NC
		D/FG/FY	D/R/Y	Stop
		R/D/FY	R/FY/R	NC
	FG/FY(D)	FG/D, D/FY	FY/R	NC
421- Limited to Stop	R/FY/R	R/FY/D	NA	Stop
		D/FY/R	D/R/Y	Stop
		R/D/R	R/R/Y (w/o DV plate)	Stop
	FY/R(D)	D/R	R/Y (w/o DV plate)	Stop
		FY/D	NA	Stop
422- Medium to Clear	R/G/R	R/D/R	R/Y/R	NC
		D/G/R	D/R/Y	Stop
		R/G/D	NA	Stop
	G/R(D)	D/R	Y/R	NC
		G/D	NA	Stop
423 - Medium to Limited	R/G/FG	R/G/D	R/Y/R	NC
		D/G/FG	D/R/Y	Stop
		R/D/FG	R/Y/R	NC
	G/FG(D)	D/FG, G/D	Y/R	NC
424- Medium to Medium	R/G/G	R/G/D	R/Y/R	NC
		D/G/G	D/R/Y	Stop
		R/D/G	R/Y/R	NC
425- Medium to Slow 425a - Medium to Diverging	R/G/FY	R/G/D	R/Y/R	NC
		D/G/FY	D/R/Y	Stop
		R/D/FY	R/Y/R	NC
	G/FY(D)	D/FY, G/D	Y/R	NC
427- Medium to Stop	R/Y/R	R/Y/D	NA	Stop
		D/Y/R	D/R/Y	Stop
		R/D/R	R/R/Y (w/o DV plate)	Stop
	Y/R(D)	D/R	R/Y (w/o DV plate)	Stop
		Y/D	NA	Stop
428 - Diverging to Clear 431- Slow to Clear	R/R/G	R/R/D	R/R/FY	NC
		D/R/G, R/D/G	NA	Stop
	R/G	R/D	R/FY	NC
	G(D)	D	FY	NC
	R/G(D)	D/G	NA	Stop
R/D		R/FY	NC	
432- Slow to Limited	R/FY/FG	R/FY/D	R/R/FY	NC

Rule	Aspect	Light Out	Downgraded Aspect	Code (Line Circuit) Out
432a - Diverging to Limited		D/FY/FG	D/R/FY	Stop
		R/D/FG	R/R/FY	NC
433- Slow to Medium 433a - Diverging to Medium	R/FY/G	R/FY/D	R/R/FY	NC
		D/FY/G	D/R/FY	Stop
434- Slow to Slow 434a - Diverging to Diverging	R/FY/FY	R/D/G	R/R/FY	NC
		R/FY/D	NA	Stop
		R/D/FY	R/R/FY	NC
429 - Diverging to Stop 435- Slow to Stop	R/FY/FY	D/FY/FY	D/R/FY	Stop
	R/R/FY	D/R/FY, R/D/FY	NA	Stop
430- Diverging 436 - Restricting	R/R/Y	D/R/Y, R/D/Y	NA	Stop
	R/Y(D)	D/Y	NA	Stop

Note: Electronic DV plate shall be considered as "w/o DV plate" while using this table.

Table 18 Intermediate Signal Aspect Downgrade Table

Rule	Aspect	Light Out	Downgraded Aspect	Code (Line Circuit) Out
405- CLEAR	G/R	D/R	FY/R	Downgrade
		G/D	NA	Stop
	G	D	FY	Downgrade
406- Clear to Limited	Y/FG	Y/D	Y/R	Downgrade
407- Clear to Medium	Y/G	Y/D	Y/R	Downgrade
408 - Clear to Diverging 409- Clear to Slow	Y/Y	Y/D	Y/R	Downgrade
411- Clear to Stop	Y/R	Y/D	NA	Stop
412- Advanced Clear to Limited	FY/FG	FY/D	FY/R	Downgrade
413- Advanced Clear to Medium	FY/G	FY/D	FY/R	Downgrade
414- Advanced Clear to Slow	FY/Y	FY/D	FY/R	Downgrade
415- Advanced Clear to Stop	FY/R	FY/D	NA	Stop

5.12 Electric Locking

5.12.1 Signalling System shall incorporate the following electric locking functions in compliance with AREMA C&S Manual Section 2 - Railroad Signal System, and Section 16 - Vital Circuit and Software Design.

5.12.2 Route locking

- a) All signal routes shall be provided with route locking to prevent the movement of any switch, moveable point frog or derail underneath or in advance of a Train within an established route.
- b) The route locking shall vitally prevent any opposing or conflicting train movements within interlocking and Control Point.

- c) The sectional release function shall be provided to release the route locking in sections behind a train moving through a route where possible and applicable without compromising train operation safety.

5.12.3 Time locking

- a) All controlled signals shall be provided with time locking. The time locking function shall be activated before a signal can be cleared. Once route locking is established, it shall not be released until the time locking function is released.
- b) No failure, such as track circuit failure, power failure or VMIS failure shall release the time locking.
- c) Time locking timing shall come into effect when:
 - i. approach locking is employed and the approach tracks are occupied, or
 - ii. approach locking is not employed, and the signal goes back to its most restrictive state through cancellation by any means other than normal train operation.
- d) Time locking settings shall be computed in accordance AREMA C&S Manual Part 2.4.20.
 - i. The predetermined time locking setting shall be shown on the Program Configuration design in the design package, and be documented on the vital software description document.
- e) The minimum timer value is recommended as 60 seconds where an inoperative approach signal or no approach signal is present, e.g. exiting non-signalled track when the maximum authorized speed does not exceed 15 mph. If the authorized speed exceeds 15 mph the minimum timer value is recommended as 180 seconds.
- f) The minimum timer value shall be 180 seconds for all other configurations.
- g) When a common timer is used for multiple signals, the greatest time calculated shall be used.
- h) Refer to Figure 9 for a time locking scenario. After signal 3W is cleared for a train movement towards signal 1W, time locking shall be in effect as there is no track circuit to the east of signal 3W.

Figure 9 - Approach / Time Locking Layout

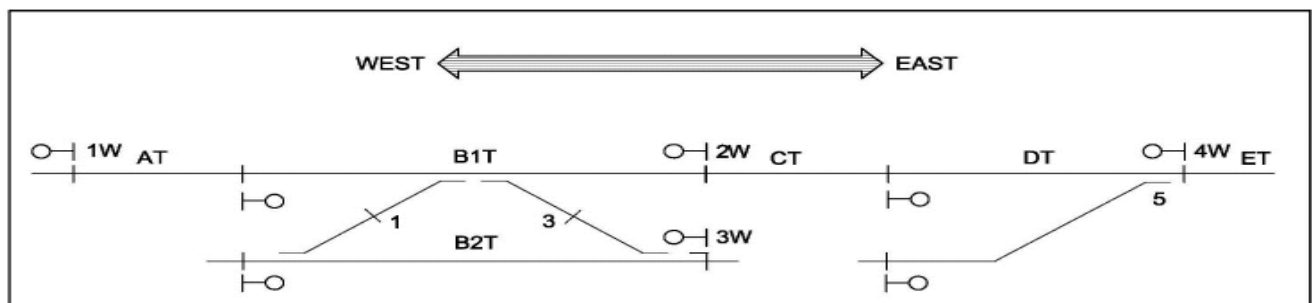

5.12.4 Indication locking

- a) For Metrolinx application, indication locking applies to the switches interlocked with the Signalling System. If a switch on a route is not established in the desired position, the signal shall not be cleared. After a signal is cleared, and the switch on the cleared route loses correspondence, the cleared signal shall be reverted to its most restrictive aspect.

5.12.5 Detector locking

- a) Detector locking shall be initiated when there is a lack of positive indication of a track circuit vacancy, e.g. when any of the following conditions exist:
 - i. Track circuit is occupied within which there is a power operated switch, movable point frog or a derail.
 - ii. A cleared signal has been downgraded to STOP or the most restricted aspect if any track circuit in the route is occupied or failed.
 - iii. For paired powered switch machines, either of the switches has track circuit occupancy.
- b) As detector locking is a vital function, no failure of a track circuit or VMIS shall release the detector locking.
- c) Once the track circuit indicates that an occupancy no longer exists, detector locking shall be released after the prescribed loss of shunt timing.

5.12.6 Traffic locking

- a) The traffic locking function shall prevent opposing signals to clear routes into the same track section.
- b) For sections of track where traffic locking is applicable, the traffic locking shall lock the direction of the traffic whenever
 - i. any track circuit within that section becomes occupied,
 - ii. an interlocking route is requested into that section, or
 - iii. time or approach locking on a route set into the section is in effect.
- c) The traffic locking shall prevent a signal clearing a route into a section until the direction of the traffic has been established and locked in the intended direction.
- d) No failure such as power loss or VMIS failure shall release the established traffic locking.
- e) Wherever possible fibre optic cables shall be designed between adjacent Control Points to transfer the electric locking conditions fulfilling the traffic locking function.
 - i. Electric locking conditions including route requests, routing locking and signal clearing shall be transmitted from a Control Point to adjacent Control Point such that opposing signals at the adjacent Control Point are prevented from clearing.
- f) If fibre optic cables are not available, the traffic locking conditions shall be transferred via coded track circuit to the adjacent Control Point, in which the following transmission delay factors shall be taken into account:
 - i. The signal delay clearing timer shall be calculated and designed based on the actual field configurations,

- ii. 3s shall be considered for each coded track circuit,
 - iii. 2s shall be considered as the processing time for the adjacent Control Points.
- g) Signal clearing shall not be delayed for Call-On, Return to Train or Switching operations.
- h) Cleared signal shall not be affected by any opposing signal request.

5.12.7 Approach locking

- a) Approach locking function shall be provided for all controlled signals unless otherwise directed by Metrolinx.
- b) No failure such as track circuit or VMIS shall release the approach locking.
- c) Improper track occupancy of the release tracks shall not release approach locking.
- d) Local reset of time shall be incorporated into the design, for maintenance and testing purposes. This function shall only be implemented during the Local Control Mode. A two steps resetting procedures shall be provided, where the first step is to apply the AS Reset Jumper, and the second is to toggle the ASR reset pushbutton on Local Control Panel.

5.12.8 Switch Locking

- a) Switch locking shall ensure that all the power switches, derails, movable point frogs are electrically locked while a signal is cleared or the train is moving within the route governed by the cleared signal.
- b) The switch locking function shall remain effective during time locking/approach locking/detector locking/route locking/switch blocking/flank protection functions. Track blocking shall not inhibit a switch movement but shall only inhibit a signal route through the blocked track circuit.
- c) No failure of a track circuit or VMIS shall release the switch locking.

5.12.9 Sectional Release

- a) Signalling System shall incorporate a sectional release function wherever practicable, through which route locking is released in sections behind a train moving through that route.
- b) The sectional release function shall release switches, derails, movable point frog and movable bridges in the route as track circuits are sequentially shunted and re-energized through the route, freeing them for other routes.
- c) The design of sectional release points in the circuits shall consider the following:
 - i. fouling by equipment that is standing or moving on adjacent or intersecting tracks,
 - ii. movement of switches or establishing another route creating a possibility for equipment fouling, and
 - iii. slack action resulting in the reverse movement of the tail end of the train.
- d) Where fouling does not permit immediate sectional release, both the fouling track circuit and the track circuit on the route shall be unoccupied before release can occur.

5.12.10 Loss of Shunt

- a) A Loss of Shunt function shall be provided in accordance with AREMA C&S Manual Section 16 "Vital Circuit and Software Design Part 16.4.8, Section 2.2.10, Section 2.2.15, Section 2.4.1, Section 2.4.5, Section 2.4.10" to prevent the track circuit from energizing due to the momentary loss of shunt.

5.13 Field Blocking

5.13.1 General Requirements

- a) Design contractor shall follow the contract requirements and Metrolinx's directions with respect to the type of the field blocking and locations to be deployed.

5.13.2 Signal blocking

- a) Signal blocking shall be a vital function that has two forms:
 - i. Entrance blocking, and / or
 - ii. Exit blocking.
- b) The state of signal blocking shall be maintained by the vital logic.
- c) Entrance blocking shall ensure no route can be established from the blocked entrance signal.
- d) Entrance blocking shall be established only when the signal is not requested, cleared, or fledged and Time Locking is not in effect for that signal.
- e) Exit blocking shall ensure the selected signal cannot be used as an exit point for any routes, including those routes that would use that signal as part of a through route.
- f) Exit blocking shall be applied only when the signal is not part of a cleared route.
- g) A request to establish signal blocking on a signal that is against items d) and f) shall be rejected, an alarm shall be generated, and the route request, established route, and time locking shall not be adversely affected.
- h) Initiation and Cancellation
 - i. Individual signal blocking initiation and cancellation requests shall only be available from GTCS.
 - ii. Signal blocking status indication shall be available on both GTCS and LCP displays.
 - iii. The blocking request shall be sent to the Signalling System wayside non-vital logic that passes the blocking request on to the vital logic.
 - iv. The vital logic shall determine whether to place the blocking into effect or not.
- i) Failure Mode Performance
 - i. No failure of a track circuit or VMIS shall release signal blocking that had been previously set.
 - ii. When applied in a VMIS with or without redundancy, upon total failure and reboot of either the single or both normal and backup VMISs, signal blocks shall be in effect upon VMIS power up.

- iii. If communications between the Control Point and GTCS are intact, the GTCS will initiate a synchronization of blocking process such that commands that were initiated at the GTCS while the VMIS was not available will be cancelled.
- iv. In a redundant VMIS architecture, if the offline VMIS reboots, all field blocks shall be in effect upon power up, but the states of the signal blocks shall be read from the online VMIS to synchronize the field block states between the two redundant systems.
- v. In a redundant architecture, if the online VMIS is the unit that has rebooted, signal blocking state synchronization will be done by the GTCS such that commands that were initiated at the GTCS while the VMIS was not available will be cancelled.

5.13.3 Track Blocking

- a) Track blocking shall be a vital function.
- b) The state of track blocking shall be maintained by the vital logic.
- c) Track blocking shall ensure no route including Call-On can be established that would traverse or enter a blocked track circuit or if the blocked track circuit would be fouling to the route.
 - i. In order to accommodate the application of CROR rules 567.2, 567.3, and 618.1 (clear signal into blocked track after Protection Against Restriction has been issued to a movement), signal shall be cleared into the blocked track circuit if a request is received from the GTCS.
 - ii. Route shall be cancelled after the route is consumed by the train and the same procedures will be required if the signal needs to be cleared again.
- d) Track blocking shall be designed as a separate function for each individual OS track circuit and exit block.
- e) Track blocking shall not affect the ability to move switches located in a blocked track.
- f) Track blocking shall be able to be established regardless of the track circuit occupancy status.
- g) Track blocking design shall follow recommended design guidelines within AREMA C&S Manual Part 16.4.40.
- h) A request to establish a track block for a track circuit that is either part of, or fouling, a cleared, requested, or fleeted route shall be rejected, an alarm shall be generated, and the established route or route request shall not be adversely affected.
- i) Initiation and Cancellation
 - i. Individual track blocking initiation and cancellation request shall only be available from GTCS.
 - ii. Track blocking status indication shall be available on both GTCS and LCP displays.
 - iii. The blocking request shall be sent to the Signalling System wayside non-vital logic that passes the blocking request on to the vital logic.
 - iv. The vital logic shall determine whether to place the blocking into effect or not.
 - v. Track blocking cancellation requests shall have no restriction, i.e. can be made at any time.

- j) Failure Mode Performance
 - i. No failure of track circuit or VMIS shall release track blocking that had been previously set.
 - ii. When applied in a VMIS with or without redundancy, upon total failure and reboot of either the single or both normal and backup VMISs, track blocks shall be in effect upon VMIS power up. If communications between the Control Point and GTCS are intact, the GTCS will initiate a synchronization such that commands that were initiated at the GTCS while the VMIS was not available will be cancelled.
 - iii. In a redundant VMIS architecture, if the offline VMIS within a subzone reboots, all track blocks shall be in effect upon power up, but the states of the track blocks shall be read from the online VMIS to synchronize the track block states between the two redundant systems.
 - iv. In a redundant VMIS architecture, if the online VMIS is the unit that has rebooted, track blocking state synchronization will be done by the GTCS such that commands that were initiated at the GTCS while the VMIS was not available will be cancelled.

5.13.4 Switch blocking

- a) Switch blocking shall be a vital function.
- b) The state of switch blocking shall be maintained by the vital logic.
- c) Switch blocking shall inhibit a specific switch from moving from the blocked position.
- d) Switch blocking shall be designed as a separate function for each individual single switch and crossover.
- e) Switch blocking shall be able to be established in either normal or reverse position, as long as the switch is in correspondence at the time the switch block request was received.
- f) While switch blocking is in effect, the associated switch lock shall be in effect, i.e. the switch shall be locked. This will prevent the switch from moving out of the position in which it was blocked for as long as the switch blocking function is in effect.
- g) Switch blocking shall allow routes over the blocked switch if the position in which the switch is blocked is appropriate for the route.
- h) If a switch block request is received from the GTCS for a switch that is out of correspondence, the request shall be rejected, and an alarm shall be generated.
- i) The setting of a switch block shall not affect any established routes or any ongoing train movements.
- j) Initiation and cancellation
 - i. Individual switch blocking initiation and cancellation request shall only be available from the GTCS.
 - ii. Switch blocking status indication shall be available on both the GTCS and LCP displays.
 - iii. The blocking request shall be sent to the Signalling System wayside non-vital logic that passes the blocking request on to the vital logic.
 - iv. The vital logic shall determine whether to place the blocking into effect or not.

- v. Switch blocking cancellation requests shall have no restriction, i.e. can be made at any time.
- k) Failure Mode Performance
- i. No failure of track circuit or VMIS shall release switch blocking that had been previously set.
 - ii. When applied in a VMIS with or without redundancy, upon total failure and reboot of either the single or both normal and backup VMIS, switch blocks shall be in effect upon VMIS power up. If communications between the Control Point and GTCS are intact, the GTCS shall initiate a synchronization such that commands that were initiated at the GTCS while the VMIS was not available shall be cancelled.
 - iii. In a redundant VMIS architecture, if the offline VMIS within a subzone reboots, all switch blocks shall be in effect upon power up, but the states of the switch blocks shall be read from the online VMIS to synchronize the switch block states between the two redundant systems.
 - iv. In a redundant VMIS architecture, if the online VMIS is the unit that has rebooted, switch blocking state synchronization will be done by the GTCS such that commands that were initiated at the GTCS while the VMIS was not available will be cancelled.

5.14 Special Operations Requirements

5.14.1 Call-On (Following Move Operation)

- a) Call-On shall be a vital function that receives non-vital requests from either the GTCS or LCP.
- b) Call-On shall be requested by operation of the Call-On control from either GTCS or LCPs.
- c) The state of Call-On shall be maintained by the vital logic.
- d) Call-On shall only be cleared to a restricting aspect.
- e) Call-On route shall be available to be set when all conditions are favorable for the signal to clear except for the route beyond the exit point (e.g. exit block is down).
 - i. Call-On shall only be set if there is no track occupancy between the entrance signal and the exit point (all OS track circuits on the route shall be energized).
- f) Call-On shall be vitally inhibited if any fouling track to the route is indicating occupancy.
- g) Whenever a Call-On route is set, inhibit shall be provided to opposing traffic until the route is cancelled or the train movement is completed.
 - i. Call-On function shall be provided for controlled signals capable of displaying a more permissive aspect than restricting. The restricting aspect for these signals shall be initiated by requesting a "Call-On" regardless of the application requiring that aspect.
 - ii. The restricting aspect shall change to Stop once the OS track circuit in advance of the signal is occupied.
 - iii. Call-On function shall be vitally inhibited if the signal blocking or any track blocking is active regardless whether the track is inside the route or fouling the route.
 - iv. Call-On shall be cancelled either automatically after the train movement is complete or manually from either GTCS or LCPs by cancelling the same signal request.
 - v. Call-On function shall be disabled when fleeting function is active for the same signal.

- h) Call-On availability status indications shall be provided to both GTCS and LCP.

5.14.2 Return to Train (RTT) Operation

- a) In order for a train coming to a controlled signal and leaving its cars on the approach track to this signal, a RTT function shall be provided to permit the locomotive to return to those cars. The provision of RTT function shall enable a locomotive to return to the occupied track by the signal clearing the restricting aspect.
- b) RTT shall be a vital function that receives non-vital requests from either the GTCS or LCPs.
- c) RTT shall use same request as the Call-On request.
- d) The state of RTT shall be maintained by the vital logic.
- e) RTT functional design shall comply with the recommendations from AREMA C&S Manual, Part 16.4.21.
- f) After an RTT route request is received, the signal logic protecting that route shall clear a restricting aspect only if all conditions are favorable for the signal to clear except for the route beyond the exit point (e.g. the exit block is occupied).
- g) RTT route availability status indications shall be provided to both the GTCS and LCP.

5.14.3 Switching Operation

- a) Under normal circumstances, no route shall be established for a signal where the track sections protected by the signal are occupied, nor shall opposing routes be requested at the same time. Therefore, a locomotive cannot normally perform switching operations between any opposing signals.
- b) However, a switching function shall be provided to permit the opposing routes to be set regardless of the track occupancy status between these opposing signals so that a locomotive can perform switching operations.
- c) At some locations, where the need is required, a switching function can be used to relieve the RTC from clearing a signal numerous times.
- d) Switching shall be a vital function that receives non-vital requests from either the GTCS or LCPs.
 - i. The state of switching shall be maintained by the vital logic.
 - ii. Switching function shall permit two opposing routes to be set with the opposing signals displaying restricting aspect regardless of the track circuit occupancy status between these two opposing signals.
 - iii. Switching routes and their restricting aspects shall not be cancelled by the train movements.
 - iv. Switching function shall be allowed only when the switches are locked by the route locking and their correspondences are aligned between these two opposing signals.
 - v. In the case where traffic circuits are involved, the design shall follow the recommendations from AREMA C&S Manual, Part 16.4.3, item 3.c.
 - vi. In the case where hand throw switches and / or grade crossings are involved, the design shall follow the recommendations from AREMA C&S Manual, Parts 16.5.2 and 16.30.9.

- vii. Switching function shall comply with switching associated rules specified in CROR.
- viii. Either the GTCS or LCP shall be able to request a switching route, via switching request and signal request.
- ix. Once switching route is established, Call-On requests to any of the signals involved in the switching route shall be inhibited.
- x. Switching status indication shall be available on both the GTCS and LCP displays.
- xi. Switching cancellation shall be possible from either the GTCS or LCPs, via the cancellation of the signal.

5.14.4 Fleeting333333

- a) Fleeting shall be a non-vital function, which is used to minimize the number of operator actions required when multiple trains are moving consecutively through the same route.
- b) Once set, fleeting shall automatically request a signal to clear for a following move on the same route that was previously established once a given train has passed beyond the entering track circuit of the interlocking that returned the signal to red (slots off the signal).
- c) The fleeting function shall operate by maintaining the entrance selected function in the energized state.
- d) The fleeting function shall maintain locking and inhibit sectional release since the signal request is maintained with fleeting.
- e) Fleeting shall disable the Call-On and require the block to clear before the signal can become permissive.
- f) The fleeting function shall not be available for dwarf signals in yard areas unless otherwise directed by Metrolinx.
- g) Fleeting shall be requested by operation of the fleeting control associated with an individual signal from either GTCS or LCPs.
- h) The fleeting request shall be sent to the Signalling System non-vital logic where checks are made to confirm that a route is established, and the signal has cleared.
- i) Fleeting shall remain in effect for the signal until the associated signal is cancelled.
- j) The Fleeting status of each signal shall be clearly displayed on both GTCS and LCP.

5.15 Remote, Local, and Field Control

5.15.1 General Requirements

- a) This section defines the design requirements for control modes and how to transfer from one mode to another.
- b) Signalling System shall have three control modes, Remote Control from GTCS, Local Control from LCP, and Field Control from the switch machine.

- c) Transfer of control, whether controlled by GTCS or LCP, shall not affect the vitality of the Signalling System nor disrupt or alter any established routes or other controls in effect at the time of the transfer.
- d) GTCS has all the controls and indications required to control and supervise train operations on the Metrolinx territory. When a field location is in GTCS control, it is referred as in Remote Control Mode. Most of the time, a field location is in Remote Control Mode.
- e) LCPs shall be provided at each Control Point. LCPs are used to enable the local control of train operations when required and facilitate maintenance including trouble shooting and maintenance testing when needed. When a Control Point is controlled by LCP, it is referred to Local Control Mode.
- f) Field Control (FC) is for maintenance testing to control individual switch machine in the field. FC is established from LCP. Proper verbal communications between RTC and field operators are required to ensure the protection is in place.
 - i. After FC is established from LCP, all switches controlled by the same LCP shall be placed into FC mode. No route can be selected nor can any switches be thrown at the Control Point by either remote or local controls.
- g) The Signalling System shall incorporate measures to prevent the any control of Signalling System including switches, signals, SCDs, etc, from more than one control mode at any given time.

5.15.2 Remote Control Mode

- a) Remote control mode shall be the control mode and be available at Control Point having an intact communication link to the GTCS where the remote control is selected on LCP.
- b) The remote control mode shall ensure a field location accepts controls only from GTCS to provide safe and efficient Signalling System control within and around that location.
- c) The Signalling System indications and alarms shall be transmitted to GTCS even if the field location is not in the remote control mode.
- d) Remote control mode shall allow LCP to issue alarm acknowledgements if and where applicable.
- e) The control mode transfer between remote and local shall be seamless and any set routes or other data shall not be lost or altered during the transfer.

5.15.3 Local Control Mode

- a) Local control mode shall be the operation control mode for each field location when the local control is selected on the LCP by an authorized user, and LCP is healthy.
- b) When in local control mode the Control Point shall only accept controls from the LCP to provide safe and efficient train operations and maintenance within and around that location.
- c) The Signalling System indications and alarms shall be available to be displayed on LCP regardless of whether the Control Point is in local control mode or not.
- d) When in local control mode, the transfer to the remote control mode shall be available as soon as the authorized user selects remote control on the LCP except that:

- i. if field blocking is designed for the location, the vital input for local global cancellation of the field blockings shall be removed before the control mode is able to be transferred from Local Control to Remote Control.

5.15.4 Field Control Mode (FCM)

- a) FCM shall enable an authorized user to control switch machine or crossover at the switch for maintenance and testing purposes.
- b) FCM shall be the control mode when field control is selected on the LCP, and
 - i. no routes within the Control Point are established or run time, and
 - ii. LCP is healthy.
 - iii. All originally cleared signal shall be cancelled.
- c) In FCM, control of the switch machine shall only be possible locally at the machine.
- d) When a switch is in FCM, its correspondence status shall be provided to GTCS and LCP.

5.16 Flank Protection

5.16.1 Flank Protection is a means of protecting movement of a trains across junctions by the setting and locking of switches not on the route (either manually or automatically, with automatically being preferred) to prevent being fouled by the movement of any other train.

5.16.2 Flank Protection shall be provided when the following two criteria are met:

- a) Two turnouts forming a crossover are both set for parallel routes, and
- b) The forcing of the switch or switches will not adversely affect train movements on other legitimate routes.

5.17 Remote Controls and Indications

5.17.1 The Signalling System shall receive remote control from GTCS, and provide indications to GTCS.

5.17.2 Typical Control and Indications

- a) Table 19 below defines the typical remote controls and indications for Control Points. The application will vary depending on the configurations of the Control Point to be designed.

Table 19: Typical Controls and Indications

Section	Equipment Type	Controls	Indications
1	Signals	<ol style="list-style-type: none"> 1. Signal Request 2. Signal Cancel 3. Signal Fleeting 4. Signal Call-On 5. Signal Switching 6. Signal Blocking 	<ol style="list-style-type: none"> 1. Signal Cleared 2. Signal Fleeted 3. Signal Call-On (exit track) 4. Signal Return to Train (exit track) 5. Signal Switching 6. Signal Light Out (1 per signal) 7. Remote Signal Light Out 8. Signal Route Locked 9. Signal Blocked
2	Switches	<ol style="list-style-type: none"> 1. Switch Normal 2. Switch Reverse 3. Switch Blocking 	<ol style="list-style-type: none"> 1. Switch Normal 2. Switch Reverse 3. Switch Locked 4. Switch Overload 5. Switch in Hand Throw 6. Switch Blocked
3	Track	<ol style="list-style-type: none"> 1. Track Blocking 	<ol style="list-style-type: none"> 1. Block Track Circuit Occupancy 2. Approach Track Circuit Occupancy 3. Over Switch Track Circuit Occupancy 4. Track Blocked
4	Power		<ol style="list-style-type: none"> 1. AC Power Off / Charger Failed 2. Remote AC Power Off 3. Ground Fault Detected 4. High / Low Battery Alarm 5. Foreign Energy (GEO Location Only) Alarm
5	Switch Clearing Device (SCD)	<ol style="list-style-type: none"> 1. SCD On 2. SCD Off 3. SCD Force-Off On 4. SCD Force-Off Off 	<ol style="list-style-type: none"> 1. SCD On / OFF 2. SCD Alarm
6	Miscellaneous Indications		<ol style="list-style-type: none"> 1. Local Control 2. Field Control 3. Code Fail 4. Communication Fail Between VMIS 5. VMIS Health Alarm 6. LCP Health Alarm 7. Bungalow Door Alarm 8. High temperature Alarm 9. Low Temperature Alarm

5.18 Local Controls and indications

5.18.1 Signalling System shall incorporate local control and indications via LCP. Always consult Metrolinx the LCP to be designed for the location prior to the design.

5.18.2 The local control functions shall include the capability to clear or cancel signal requests, to position switches for routes, to remove field blocking, to control SCD, and other miscellaneous functions.

5.18.3 Table 20 below defines the typical local controls, indications, hardware and configuration for Control Point, used Quest LCP as baseline. The application will vary depending on the configurations of Control Point to be designed.

Table 20 Typical Local Controls and Indications

Control	Panel Hardware and Configuration	Indication	Panel Hardware and Configuration
Signal	<p>Signal Request pushbutton, 1 per signal; Signal Cancel pushbutton, 1 per signal.</p> <p>Note: For big scale location in order to save space it is allowed to combine request / cancel pushbuttons for signals which will never be able to be cleared at the same time.</p>	<ol style="list-style-type: none"> 1. Signal Cleared 2. Signal at STOP 3. Signal Light Out 4. Remote Signal Light Out 	<ol style="list-style-type: none"> 1. 1 Red LED, above Signal Request pushbutton, normally dark, solid when pushbutton is pushed or request is established in VMIS, extinguished after pushbutton is released and signal request is cancelled manually or by train route; flashing when signal is fledted. 1 per signal. 2. 1 Red LED, above Signal Cancel pushbutton, normally dark, solid when pushbutton is pushed, extinguished after pushbutton is released. 1 per signal. 3. 1 Green LED on track map representing signal, normally dark, flashing while signal is requested and pending, solid when signal is cleared. 1 per signal. 4. 1 Red LED on track map representing signal, solid when signal is at Stop, normally lit, 1 per signal. Flashing when AS Timer is running. 5. 1 Red LED, on LCP under tracks, normally dark, solid when Signal Light Out (LO) is detected. 1 per signal. 6. 1 Red LED, on LCP under tracks, normally dark, solid when Remote Signal Light Out (RLO) is detected, 1 per track.

Control	Panel Hardware and Configuration	Indication	Panel Hardware and Configuration
Call-On / Return To Train	General Call-On/Return to Train request pushbutton, 1 per location. Work in conjunction with Signal Request pushbutton.	Call-On / Return to Train Conditions are established	<ol style="list-style-type: none"> 1 Red LED, above Call-On/Return to Train Request pushbutton, normally dark, solid when Call-On/Return to Train pushbutton is pushed and extinguished after the pushbutton is released. 1 per location. 1 Amber LED, on exit track, normally dark, solid if Call-on conditions are established, flashing if Return to Train conditions are established. 1 Per exit block. After restricting aspect is granted, the Green LED representing signal on track map shall be lit solid.
Fleeting	General Fleeting request pushbutton, 1 per location. Work in conjunction with Signal Request pushbutton.	<ol style="list-style-type: none"> 1. Fleeting Request 2. Fleeting Cancelled by Signal Cancel 	<ol style="list-style-type: none"> 1. 1 Red LED, above Fleeting Request pushbutton, normally dark, solid when Fleeting is requested and extinguished after the pushbutton is released. 1 per location. 2. Same Red LED of Signal, above the Signal Request pushbutton, flashing after signal is fledted. 1 per controlled signal. 3. Same Red LED above is out when fleeting is cancelled.
Switching	General Switching Signal Request pushbutton, 1 per switching route. Work in conjunction with Signal Request pushbutton.	<ol style="list-style-type: none"> 1. Switching Request 2. Switching Cancelled by Signal Cancel 	<ol style="list-style-type: none"> 1. 1 Red LED, above the Switching Request pushbutton, normally dark, solid when switching is requested or switching route is established. 1 per switching route. 2. Same LED above is out when switching route is cancelled.
Approach Stick Reset (ASR)	General ASR pushbutton, 1 per location. Work in conjunction with Signal Cancel pushbutton.	<ol style="list-style-type: none"> 1. ASR On 2. ASR Off 	<ol style="list-style-type: none"> 1. 1 Red LED, above ASR reset pushbutton, normally dark, solid when AS Reset activated, flashing 50 minutes after activated, and out after 60 minutes timer expired. 1 per location. 2. Same Red LED above out when ASR is Off

Control	Panel Hardware and Configuration	Indication	Panel Hardware and Configuration
Switch Machine Operation	Normal Switch request pushbutton, 1 per single switch (or crossover); Reverse switch request pushbutton, 1 per single switch (or crossover).	<ol style="list-style-type: none"> 1. Normal Position 2. Reverse Position 3. Switch Locked 4. Switch Overload 	<ol style="list-style-type: none"> 1. 1 Red LED, for Normal switch position, flashing when switch is requested normal and out of correspondence, solid when switch is in Normal Correspondence, 1 LED per single switch (or crossover) 2. 1 Red LED, for Reverse switch position, flashing when switch is requested reverse and out of correspondence, solid when switch is in Reverse Correspondence, 1 LED per single switch (or crossover) 3. 1 Red LED, solid when switch is locked, 1 LED per single switch (or crossover) 4. 1 Red LED below the normal switch request pushbutton, solid when pushbutton is pushed or normal request is established in VMIS, and extinguished after pushbutton is released and normal request becomes false in VMIS, flashing if normal side overloaded. 1 LED per single switch (or crossover) 5. 1 Red LED below the reverse switch request pushbutton, solid when pushbutton is pushed or reverse request is established in VMIS, and extinguished after pushbutton is released and reverse request becomes false in VMIS, flashing if reverse side is overloaded, 1 LED per signal switch (or crossover).
Switch Clearing Device (SCD) Normal Function	SCD On pushbutton; 1 per location SCD Off pushbutton; 1 per location	<ol style="list-style-type: none"> 1. SCD ON 2. SCD OFF 3. SCD Alarm 	<ol style="list-style-type: none"> 1. 1 Red LED above the SCD On pushbutton, solid when SCD On pushbutton is pushed, extinguished after pushbutton is released. 2. 1 Red LED above the SCD Off pushbutton, solid when SCD Off pushbutton is pushed, extinguished after pushbutton is released. 3. 1 Red LED adjacent to SCD On/Off LEDs, solid when all SCD's at the location are on and running, flashing when SCD alarm is detected, 1 per location.

Control	Panel Hardware and Configuration	Indication	Panel Hardware and Configuration
Switch Clearing Device (SCD) Force Off Function	SCD Force Off pushbutton, 1 per location; SCD Force Off Cancel pushbutton, 1 per location.	<ol style="list-style-type: none"> 1. SCD Force Off Request 2. SCD Force Off Cancel 	<ol style="list-style-type: none"> 1. 1 Red LED above the SCD Force Off Request pushbutton, solid when SCD Force Off pushbutton is pushed, and extinguished after pushbutton is released; 2. 1 Red LED above the SCD Force Off Cancel pushbutton, solid when SCD Force Off cancel pushbutton is pushed, and extinguished after pushbutton is released.
Track Occupancy	Indications Only	<ol style="list-style-type: none"> 1. Approach Block (TK) Indication 2. Over Switch (OS) Track Indication 	<ol style="list-style-type: none"> 1. 1 Red LED, normally dark, solid when Track is occupied (Code 1 or 5 not received), 1 per exit block 2. 1 Red LED, normally dark, solid when Over Switch track circuit is occupied, 1 per OS track circuit
Power and Temp.	Indications Only	<ol style="list-style-type: none"> 1. Power Off 2. Remote Power Off 3. Ground Fault 4. Low / High Battery 5. Foreign Energy 6. *Generator Running 7. *High Temperature 8. *Low Temperature 	<ol style="list-style-type: none"> 1. 1 Red LED, normally dark, solid when Power Off is detected, 1 per location. 2. 1 Red LED, normally dark, solid when Remote Power Off is detected, 1 per location. 3. 1 Red LED, normally dark, solid when a Ground Fault is detected, 1 per location. 4. 1 Red LED, normally dark, solid when a Low or high Battery condition is detected, 1 per location. 5. 1 Red LED, normally dark, solid when a Foreign Energy condition is detected at this location, 1 per location. 6. 1 Red LED, normally dark, solid when the Local Generator is running, 1 per location. 7. 1 Red LED, normally dark, solid when a High Temperature Alarm is detected, 1 per location. 8. Same LED as above, solid when a Low Temperature Alarm is detected.

Control	Panel Hardware and Configuration	Indication	Panel Hardware and Configuration
Local Control Panel (LCP) Operation Control	3 Way Keyed Selector Switch, 1 Per Location Remote Control Local Control Field Control	<ol style="list-style-type: none"> Local Control Field Control Remote Control 	<ol style="list-style-type: none"> 1 Green LED placed in reference to Remote Control key position, solid when location is under Remote Control and out when the key is in any other position, 1 per location 1 Amber LED placed in reference to the Local Control key position, solid when location is under Local Control and out when the key is in any other position, 1 per location 1 Red LED placed in reference to the Field Control key position, solid when location is under Field Control and out when the key is in any other position, 1 per location
Local Control Panel (LCP) Lighting	3 Way Toggle Switch, 1 Per Location Up - LCP Lights On Middle - LCP Lights Off Down - LCP Lights Test	<ol style="list-style-type: none"> LCP Panel Lights On LCP Panel Lights Off LCP Panel Lights Test 	<ol style="list-style-type: none"> LCP Panel will light the appropriate LED's on the panel LCP Panel lights will extinguish on the panel Test lighting of all LED's on the LCP.
Local Control Panel (LCP) Equipment Health Indications	To Provide Indications Only	<ol style="list-style-type: none"> Code Fail Comms Fail VMIS Health Alarm LCP Health Alarm Door Alarm 	<ol style="list-style-type: none"> 1 Red LED, normally dark, solid when Code Fail is detected, 1 per location. 1 Red LED, normally dark, solid when communication between VMISs failed, 1 per location. 1 Red LED, normally dark, solid if VMIS is unhealthy, 1 per location. 1 Red LED, normally dark, solid if LCP is unhealthy, 1 per location. 1 Red LED, normally dark, solid when any bungalow door opened, 1 per location.
Globally Remove Block	3 Way Momentary Toggle Switch, 1 Per Location Up - Remove Block Request Middle - Not Used Down - Remove Block Request	NA	NA

Control	Panel Hardware and Configuration	Indication	Panel Hardware and Configuration
Block Indication	NA	NA	1. Blue LED above switch on track map, normally dark, solid after the switch is blocked, and flashing when VMIS is powered up or reset. 1 per switch / crossover. 2. Blue LED above the OS track on track map, normally dark, solid after the track is blocked, and flashing when VMIS is powered up or reset. 1 per OS track circuit and per exit block.
Notes: 1) "*" is reserved for future, or defined in the contract requirements. 2) Foreign Energy indication only applicable to GEO.			

5.19 Typical Control and Indication bits used in application software

5.19.1 Table 21 - Typical Controls and Table 22 - Typical Indications define the typical controls and indications that shall be incorporated into the LCP and the interface with GTCS, in conjunction with the nomenclatures applied in the application software. Controls shall end with "Z" and indications shall end with "K".

Table 21: Typical Controls

Nomenclature	Sample Nomenclature in Application Software		
	LCP Control	RTC Control	Description
NWZ	L1NWZ(F1NWZ - Field Control)	C1NWZ	Switch 1 Normal Request
RWZ	L1RWZ (F1RWZ - Field Control)	C1RWZ	Switch 1 Reverse Request
GZ	L1WGZ	C1WGZ	Signal 1W Clear Request
STOPZ	L1WSTOPZ	C1WSTOPZ	Signal 1W Stop Request
COZ	LCOZ (1 Per Location)	C1WCOZ	Signal 1W Call-On Request
FLZ	LFLZ (1 Per Location)	C1WFLZ	Signal 1W Fleeting Request
SWGZ	LSWGZ	CSWGZ	Signal Switching Request (1 Per Switching Route)
SMZ	LSMZ (1 Per Location)	C1SMZ	SCD On Request
SMOFFZ	LSMOFFZ (1 Per Location)	C1SMOFFZ	SCD Off Request
SMFOZ	LSMFOZ	CSMFOZ	SCD Force Off Request (1 Per Location)
SMFOPZ	LSMFOPZ	CSMFOPZ	SCD Force Off Cancel (1 Per Location)
WBZON	NA	C5WBZON	Switch (crossover) # 5 switch block request on

Nomenclature	Sample Nomenclature in Application Software		
	LCP Control	RTC Control	Description
WBZOFF	NA	C5WBZOFF	Switch (crossover) # 5 switch block request off
OSBZON	NA	C1AOSBZON	OS track circuit 1AT track block request on
OSBZOFF	NA	C1AOSBZOFF	OS track circuit 1AT track block request off
TBZON	NA	C1ETBZON	1ET (exit block) track block request on
TBZOFF	NA	C1ETBZOFF	1ET (exit block) track block request off
Note: Signal blocking (both entrance and exit blocking) are not illustrated here. Design contractor shall submit proposed bit assignment to Metrolinx for approval, if signal blocking (entrance blocking or exit blocking or both) is directed by Metrolinx.			

Table 22: Typical Indications

Indication	Sample Nomenclature in Application Software			Application Design	
	LCP	GTCS	Description	True	False
NWK	L1NWK	1NWK	Switch 1 Normal Indication	Switch in normal correspondence	Switch not in normal correspondence
RWK	L1RWK	1RWK	Switch 1 Reverse Indication	Switch in reverse correspondence	Switch not in reverse correspondence
LK	L1LK	1LK	Switch 1 Locked Indication	Switch not locked	Switch locked
NJPK	L1NJPK	1NJPK	Switch 1 in Hand Throw Indication	Dual control switch on Power	Dual control switch on Hand
OLK	L1OLK	1OLK	Switch 1 Overload Indication	Switch overloaded	Switch not overloaded
GK	L1WGK	1WGK	1W Signal Cleared Indication	Signal Cleared (RGPR False)	Signal not Cleared (RGPR True)
COK	L1WCOK	1WCOK	1W Call ON Signal Indication	Following move stick established	Following move stick not established
RTTK	L1WRRTTK	1WRRTTK	1WT Return to Train Indication	RTT stick established	RTT stick not established
FLK	L1WFLK	1WFLK	1W Fleeting Indication	Signal fledted	Signal not fledted
SWGK	LSWGK	SWGK	Switching Signal Indication (1 Per Route)	Signal in switching mode	Signal not in switching mode
ASK	L1WASK	1WASK	1W Signal Route Locked Indication	Route not Locked (AS True)	Route Locked (AS False)
LOK	L1WLOK	1WLOK	1W Signal Light Out Indication	Signal light OK	Signal light OUT

Indication	Sample Nomenclature in Application Software			Application Design	
	LCP	GTCS	Description	True	False
RLOK	LRLOK (1 Per Location)	T1RLOK	Remote Light Out Indication (Remote Location on Track 1)	Remote Signal light OK	Remote Signal light OUT
POK	LPOK	POK	AC Power Off / Charger Failure Indication	Power OK	Power OFF
RPOK	LRPOK	T1RPOK	Remote Power Off Indication (Remote Location on Track 1)	Remote Power OK	Remote Power OFF
SMK	LSMK (1 Per Location)	SMK	SCD On Indication	SCD operating	SCD not operating
SMALK	LSMALK (1 Per Location)	SMALK	SCD Alarm Indication	SCD alarming	SCD not alarming
TK	L1TK	1TK	1T OS Occupancy Indication	Track Occupied	Track Vacant
TK	L1WTK	1WTK	1WT Occupancy Indication	Track Occupied	Track Vacant
BK	L1WBK	1WBK	Track 1 West Blocks Occupancy Indication	Block(s) occupied	Block(s) unoccupied
LOCALK	LLOCALK	LOCALK	Site in Local Control Indication	Local Control	Not Local Control
FIELDK	LFIELDK	FIELDK	Site in Field Control Indication	Field Control	Not Field Control
ASRESETK	LASRESETK	Not Applicable	AS Timer Reset Indication LCP Function Only	AS reset	AS not reset
LCPHTK	LLCPHTK	LCPHTK	Local Control Panel Health Status Indication	LCP Healthy	LCP Not Healthy
VMISHTK	LVMISHTK	VMISHTK	VMIS Health Status Indication	VMIS Healthy	VMIS Not Healthy
DOORK	LDOORK	DOORK	Bungalow Door Indication	Door Closed	Door Open
*GENK	*LGENK	*GENK	Generator Running Indication	Generator ON	Generator OFF
*HITEMPK	*LHITEMPK	*HITEMPK	High Temperature Alarm Indication	High Temperature ON	High Temperature OFF
*LOWTEMPK	*LLOWTEMPK	*LOWTEMPK	High Temperature Alarm Indication	Low Temperature ON	Low temperature OFF
HGHBATTK	LHGHBATTK	HGHBATTK	High Battery Indication	High Battery Voltage Alarm ON	High Battery Voltage Alarm OFF

Indication	Sample Nomenclature in Application Software			Application Design	
	LCP	GTCS	Description	True	False
LOWBATTK	LLOWBATT K	LOWBA TTK	Low Battery Indication	Low Battery Voltage Alarm ON	Low Battery Voltage Alarm OFF
FEK	LFEK	FEK	Foreign Energy Indication	Foreign Energy	No Foreign Energy
GFK	LGFK	GFK	Ground Fault Indication	Ground Fault	No Ground Fault
CODEFAILK	LCODEFAI LK	CODEF AILK	Code Fail Indication	Code Fail	No Code Fail
COMMK	LCOMMK	COMM K	Communications Failure Between VMISs	Communication Ok	Communication Fail
WBLKON	L1WBLKO N	1WBLK ON	Switch (crossover) # 1 block indication	Switch (crossover) #1 blocked	NA
WBLKOFF	L1WBLKOF F	1WBLK OFF	Switch (crossover) # 1 block indication	Switch (crossover) #1 block off	NA
OSBLKON	L1AOSBKO N	1AOSB KON	1AT block indication	1AT blocked	NA
OSBLKOFF	L1AOSBKO FF	1AOSB KOFF	1AT block indication	1AT block off	NA
TBLKON	L1WTBKO N	1WTBK ON	1WT block indication	1WT blocked	NA
TBLKOFF	L1WTBKOF F	1WTBK OFF	1WT block indication	1WT block off	NA
Notes: 1) "*" is reserved for future, or defined in the contract requirements. 2) FEK is only available at GEO locations, and only reset is required. 3) Signal blocking (both entrance and exit blocking) are not illustrated here. Design contractor shall submit proposed bit assignment to Metrolinx for approval, if signal blocking (entrance blocking or exit blocking or both) is directed by Metrolinx.					

6. Grade Crossing Warning System

6.1 General

6.1.1 Grade Crossing Warning System (GCWS) device on public crossing shall include flashers, bell(s), and gates. Gates shall include both entrance gates, to block road traffic, and pedestrian gates if there is sidewalk.

- a) The pedestrian gates shall operate in unison with the entrance gates.
- b) Flashers shall operate in unison.

6.1.2 The design and placement of the warning devices shall comply with the:

- a) Grade Crossing Standards & Grade Crossing Handbook;

- b) AREMA C&S Manual Section 3 “Highway-Rail Grade Crossing Warning System”; and
 - c) the following GO Transit Signal & Communications Standards - Codes of Practice:
 - i. SCP-702 Preferred Locations for S&C Housings at Highway Crossings
 - ii. SCP-703 Cantilever Type Signal Structures and Flashing Light Signal Requirements at Road Crossing Warning Systems;
 - iii. SCP-704 Location and Clearance of Highway Crossing;
 - iv. SCP-705 RCWS Safety Assurance Process;
 - v. SCP-706 Road Crossing Device Light Unit Alignment Procedures; and
 - vi. SCP-709 Procedures to be followed by S&C Employees in the Deactivation of Road Crossing Warning Systems.
- 6.1.3 The placement of the warning devices shall take into account sightlines determined in accordance with the Grade Crossing Standards, Section 7.
- ## 6.2 Grade Crossing Safety Assessment
- 6.2.1 Design Contactor shall conduct Crossing Safety Assessment (CSA) for the Grade Crossing equipment with GCWS to be modified or added.
- a) Design contractor may use the existing CSA report provided by Metrolinx as the baseline for the CSA.
 - b) Design contractor is not required to conduct the CSA for minor changes (such as replacing incandescent bulbs with LEDs) and such requirement is specified in the contract requirements.
- 6.2.2 CSA shall be performed in accordance with:
- a) Grade Crossing Handbook Article 31;
 - b) Canadian Road/Railway Grade Crossing Detailed Safety Assessment Field Guide, which provides a comprehensive guide for conducting grade crossing safety assessments; and
 - c) GO Transit Signals & Communications Standards - Codes of Practice provide additional information concerning evaluating Grade Crossings:
 - i. SCP-1210-5 Road Crossing Train Movement Data, to be used by design contractor to determine and record train movement data.
 - ii. SCP-1210-6 Road Crossing Inspection Data, to be used by design contractor to determine and record the proposed crossing warning system and warning device, location and road details, photographs, track data, track layout details, excavation data, power service data, clearance data, and hardware data (additional lights, cantilevers, switches in the approach).
 - iii. SCP-1210-7 Road Crossing Vehicular Traffic Data, to be used by design contractor to determine and record road data, road measurement, center line of the road, and interconnections.
- 6.2.3 While conducting the CSA design contractor shall fill the SCP 1210 forms (or forms in similar format) for each road approach to the Grade Crossing to indicate the posted speed limit and

the distance from the crossing to the obstruction or change in road direction that would prevent a clear view of the warning devices. The SCP 1210 form shall also indicate the distance from the crossing of all road accesses or intersections within 90 m (300 ft).

6.2.4 Design contractor shall provide CSA to Metrolinx for review, approval and record.

6.3 **Grade Crossing Risk Assessment**

6.3.1 Design contractor shall prepare a Risk Assessment identifying the risks which are not identified in CSA but do pose danger to both road users and train operations, and the associated mitigations.

6.3.2 Design contractor shall provide RA to Metrolinx for review, approval and record.

6.4 **Constant Warning Time Device (CWTD)**

6.4.1 Design contractor shall design CWTD located in GCWS bungalows. CWTD shall be physically separated from the wayside bungalow for CTC Signal System applications.

a) If it is not feasible to separate CWTD from the CTC Signal System wayside bungalow, CWTD shall be physically separated from the CTC Signal System by having its own chassis, power bus, battery bank(s) and charger(s).

i. If CWTD battery bank(s) and charger(s) are combined with the CTC Signal System applications, the battery capacity shall consider the backup hours of both the CWTD and the CTC Signal System applications.

6.4.2 Control circuits that affect the safe operation of a CWTD shall activate the warning device if there is failure of safety-critical component.

a) Control circuits shall prevent nuisance warning during normal operations.

6.4.3 The CWTD shall include:

a) Consistent Warning Activation Time (CWAT) such that the system:

i. is triggered by the approach and presence of any train,

ii. accommodates all possible approach speeds.

b) automatic deactivation of GCWS that has been activated for a train that has stopped for a predetermined amount of time (configurable) prior to the Grade Crossing;

c) the subsequent re-activation of the GCWS if the stopped train has resumed movements towards grade crossing;

d) the subsequent re-activation of the GCWS by the Driving Crew of a train using commands entered on a Dual Tone Multi Frequency (DTMF) keypad; and

e) monitoring devices and recorders.

6.4.4 For the determination of train speed and position, the preferred technology currently in use in Metrolinx territory is a "crossing predictor", which is a device that can determine a train's speed

and distance from the crossing and deduce the arrival time of the train at the grade crossing. The predictor provides the ability to provide a CWAT independent of train's approach speed.

6.5 Island Circuit

6.5.1 The GWCS shall include an island track circuit that extends a minimum of 50 feet beyond both edges of the road (or sidewalk, if present) for the detection of a train within the grade crossing limits. In urban areas, an external DC track circuit with insulated joints shall be provided for the island whereas in suburb areas, it is permissible to use the internal island of CWTD without insulated joints.

6.6 Adjacent Grade Crossings (DAXing or Remote Start)

6.6.1 DAXing (or remote start) shall be provided at a Grade Crossing where train detection zone overlaps an adjacent grade crossing, either because the two adjacent crossings are closely spaced or because the Grade Crossing has long approach track circuits due to high train speeds. DAXing shall be provided when the activation of the warning system of a given Grade Crossing requires input from the adjacent upstream grade crossing on the detection of an approaching train in order to achieve a constant warning time.

6.7 Ballast Resistance

6.7.1 The crossing approach distances for Grade Crossing Warning Systems shall be based on a ballast resistance of 2 ohms per 1000 feet.

a) Any deviation from 2 ohms per 1000 feet shall require approval from Metrolinx.

6.8 Grade Crossing Warning System Circuit Design

6.8.1 The design contractor shall provide GCWS circuit design for any alterations to an existing GCWS or addition of new GCWS. The alterations to an existing Grade Crossing may include:

- a) Temporary GCWS to accommodate grade separation projects;
- b) Design and installation of additional track(s);
- c) Increase or decrease in track speed(s) for any or all types of trains;
- d) Increase or decrease in road speed(s), and volumes of road users; or road alterations such as widening of the road, additional lanes, addition of sidewalks, etc.;
- e) Addition or removal of signal equipment, including the installation or removal of signals or switches etc. within the approach of the Grade Crossing, and
- f) Safety enhancements including addition of pedestrian gates, and upgrades for compliance with Grade Crossing Standards and Grade Crossing Regulations.

6.8.2 GCWS circuit design shall include the following as a minimum:

- a) Index

- b) Signal Location Layout (SL) plan, including:
 - i. Crossing angle
 - ii. Approach lengths for all directions
 - iii. Crossing warning device layout
 - iv. Equipment response time
 - v. Gate arm clearance time
 - vi. Gate descent time
 - vii. Gate Horizontal time
 - viii. Buffer Time
 - ix. Pre-emption time
 - x. Design Speed (both rail and road)
 - xi. Clearance distance length and impact to the warning time
 - xii. Design Vehicle class to determine the gate delay
 - xiii. Total warning time for crossing activation
 - xiv. Total time for crossing approach
 - xv. Both imperial (feet and inch) and metric (meter) units shall be used for dimensions
- c) Track Layout Plan, including;
 - i. Track and signal layout
 - ii. Crossing predictors / frequencies
 - iii. Crossing warning device layout
 - iv. Crossing circuits - termination shunts and frequencies, bypass couplers and frequencies, etc.
 - v. Adjacent crossing connections (DAXing or remote start if necessary)
 - vi. Interface to CTC Signal System circuits (e.g. any DC island interfaces)
 - vii. Bungalow (size, orientation, name - e.g. RC Mi 331.21, power off lights, test switch, entrance doors)
 - viii. Power Services
 - ix. Interconnection with Traffic Signals where applicable
- d) Circuit diagrams, including
 - i. Crossing Predictor Circuit;
 - ii. Crossing Controller Circuit;
 - iii. Interconnection Circuit;
 - iv. Gate and Flasher circuits;
 - v. Deactivation Jumper Schematics;
 - vi. VHF Connections (DTMF for public crossing); and
 - vii. Data Communications.
- e) Event Recorder

- f) Program Configurations
- g) AC and DC Power Distribution
- h) Layout
 - i. Rack
 - ii. Bungalow Wall (all sides)
 - iii. Bungalow Layout (plan view)
 - iv. Main Terminal Board
 - v. Equipment Layouts
- i) Deactivation Jumper Schematics
- j) Wiring details on terminals and relay contacts

6.9 Crossing Warning Time & Approach Calculations

- 6.9.1 The Grade Crossing warning time shall be calculated in accordance with articles 16.1 "Warning Time" and 16.2 "Consistency of Warning Times" of the Grade Crossings Standards.
 - 6.9.2 Grade Crossing approach distance calculations shall be in accordance with AREMA C&S Part 3.3.10 "Recommended Instructions for Determining Warning Time and Calculating Minimum Approach Distance for Grade Crossing Warning Systems".
 - 6.9.3 The approach distance shall take into account equipment response, integrity check and switching times.
 - a) Equipment response time shall account for relay response time and communications latency time for remote starts.
 - 6.9.4 A buffer time of 5 seconds (minimum) shall be provided to accommodate minor variations in train handling, track circuit variability and allowable tolerance within train speed measurement apparatus.
 - a) For Grade Crossing in the vicinity of station platform, the buffer time shall be calculated based on the worst case train acceleration towards the Grade Crossing from the station platform.
 - b) The buffer time is the time lost assuming train continues accelerating on the crossing approach from station platform.
 - c) If the calculated buffer time is longer than 5s, the calculated time value shall be built into the total warning time.
- ## 6.10 Flasher
- 6.10.1 12" LED signals shall be used for the flashing signals installed on the signal mast and / or cantilever.

6.10.2 Flashing signal shall be numbered starting from 1, 2, 3, 4, 5, etc., for each individual signal mast or cantilever. 1 and 3 are for the signals on field side, 2 and 4 are for the signals on the road side. 1 and 2 are for the signals on approach side, 3 and 4 are for back lights. 5 is for the first signal on gate, and so on.

- a) Signal mast and cantilever shall be numbered starting from 1, 2, 3, 4, 5, etc. Signal mast on north (west) side of the tracks shall be numbered 1, 2 is for the signal mast on south (east) side of the tracks.
- b) Cantilevers shall be numbered following the signal masts, starting from the cantilevers on north (west side) of the tracks.
- c) Signal mast for pedestrian gates shall be numbered following the signal masts and cantilevers, starting from the signal mast on north (west) side.

6.11 Gate Arm

6.11.1 The gate arm shall be installed perpendicular to the longitudinal axis of the road approach.

6.11.2 The gate arm clearance time is the time, in seconds, that a “design vehicle” will take to travel from either the Stopping Sight Distance (SSD) position or the Stop position, prior to the gate, to a point beyond and clear of the gate arm.

6.11.3 Given that many of the grade crossings are unique, a design calculation for each crossing shall be provided for the gate arm clearance time as shown in the Grade Crossing Standards section 10.4, “Gate Arm Clearing Time”.

- a) Gate arm clearance time for pedestrian gate shall be calculated in accordance with Grade Crossing Handbook, section 10.4.2.

6.11.4 The gate arm decent and ascent time shall be designed based on the manufacturer’s recommendations and Grade Crossing Standards Article 15.2.2.

6.12 Signs and Road Marking

6.12.1 The traffic and railway signs and road markings shall comply with the Transport Canada Grade Crossing Standards, Section 8, “Signs”.

6.12.2 In addition, the road markings for grade crossings shall comply with the Manual of Uniform Traffic Control Devices (MUTCD) for Canada.

6.13 Battery Back Up

6.13.1 The design shall comply with the Grade Crossing Standard requirement to provide warning system battery backup for 8 hours of continuous activation or 24 hours of normal railway operations, whichever is greater.

6.14 Power Off Lights

6.14.1 In addition to a reliable battery backup, GWCS shall be equipped with two power off lights clearly visible from 100 ft from both railway and road approach during normal sunlight

conditions. One power off light shall be placed above the bungalow entrance door to draw the attention of the Driving Crew of train, and another power off light shall be placed on the road side to draw the attention of the maintainers and the passing road traffic.

6.14.2 The power off lights shall:

- a) be continuously lit during normal operating conditions, and
- b) flash to indicate a defect in accordance with CROR 103.1(h), including AC power off, charger failure, or if a deactivation jumper is applied.

6.14.3 The Power off light model shall be VELCORP GEMS LC2-001WB.

6.15 Battery Chokes and Track Filters

6.15.1 Choke coils shall be provided at the battery end if Grade Crossing train detection is used anywhere within the confines of a DC track circuit. This applies to DC track circuit battery feed and track circuit relay feed where the relay coil is 1 ohm or less.

6.15.2 Design contractor shall design the track filters following manufacturer's instructions if Grade Crossing train detection is in the vicinity of the coded track circuit.

6.16 Road Traffic Signals

6.16.1 An Interface with Road Traffic Signals is required to activate or change the sequencing of road traffic signals, at location where there is queuing issues at the crossing surface; or when an advance warning signal is required, at location where the sighting distance within the Stopping Sight Distance (SSD) is inadequate. The function of this interface is also referred to as pre-emption.

6.16.2 The design of the interconnection of the GCWS with traffic signals shall comply with:

- a) Section 19 of Transport Canada's design standards for pre-emption of traffic signals, and
- b) Part 3.1.10 of the AREMA C&S Manual.

6.16.3 Design contractor shall coordinate with Metrolinx for Grade Crossing with existing or new interconnections with road traffic signals, and shall ensure the interface meets the requirements of each individual road authority.

6.16.4 The GCWS shall design manual test switch that:

- a) initiates a pre-emption signal where the interconnection is for advance warning signal, or for queue cutter traffic signals to display stop; and
- b) initiates or not initiate a clear-out phase of the traffic signals before activation of GCWS, per the individual road authority's requirements and Metrolinx' directions.

6.17 Manual Grade Crossing Activation and Deactivation

6.17.1 The GCWS shall provide the manual activation and deactivation via:

- a) Dual Toned Multi-Frequency (DTMF) links (initiated within the cab of the train); and
- b) the manual test switch.

6.17.2 The GCWS shall provide deactivation jumpers for applicable approaches and islands in accordance with the following:

- a) Deactivation jumper terminals shall be located together in one area on the wall in the bungalow, clearly visible to maintainers;
- b) Deactivation jumper shall have caps and shields to help prevent unintended deactivations;
- c) Deactivation jumper terminals shall be installed on the jumper panel with a yellow surface;
- d) Whenever the deactivation jumper is applied, the power off lights shall be flashing.

6.18 **Event Recorder**

6.18.1 Event recorder shall be provided for GCWS with sufficient capacity to record the following vital and non-vital events:

- a) AC Power On / Off
- b) Charger failed
- c) Gate Up (1 Per Gate)
- d) Gate Down (1 Per Gate)
- e) EMG Fault Operations (Gate arm knocked off / pumping))
- f) Warning Devices Health (bell, flashing lights)
- g) Crossing Predictor / Controller Health
- h) Ground Fault
- i) Battery High / Low Voltage
- j) Warning System Active
- k) Warning Time
- l) Pre-Emption Active
- m) Approach Track Circuit
- n) Island
- o) DAXing or Remote Start
- p) DTMF Activation
- q) Test Switch Activation

- r) Deactivation Jumper
- s) Data recorded in GCWS

6.19 Crossing Remote Controls and Indications

6.19.1 Metrolinx will gradually implement remote reporting functions for remote monitoring and diagnostics purposes.

- a) Design contractor shall design the infrastructure to support remote reporting function.

6.19.2 Remote reporting functions shall follow AREMA C&S Manual Part 3.1.29.

6.19.3 Table 23 below defines the typical remote indications for a grade crossing warning system. The application will vary depending on the configurations of the Grade Crossing Warning System at individual crossing locations.

- a) Remote control is reserved for future.

Table 23: Grade Crossing Remote Indications

Equipment Type	Function Description	Indications	Indications True	Indications False
Activate Crossing	Crossing Activated by Train	Future	NA	NA
Crossing Controller	Warning Activated	XK	Crossing Not Activated	Crossing Activated
	Health	CHEALTHK	Controller Healthy	Controller not Healthy
Train Detection	Predictor Health	PHEALTHK	Predictor Healthy	Predictor not Healthy
	Constant Predictor	MDK (1MDK, 2MDK, ...)	Approach not Occupied	Approach Occupied
	Island Track Circuit	ISLK	Island Not Occupied	Island Occupied
	DTMF	DTMFK	DTMF not Activated	DTMF Activated
	Test Switch Opened / Closed	TESTSWK	Test Switch Closed	Test Switch Open
	Test Switch Up	TESTSWUPK	Test Switch at Gate Up Position	Test Switch Not at Gate Up Position
	Remote Activation	DAXK (e.g. 1WDAXK)	Remote not Started	Remote Started
	Pre-Emption	PREEMPK	Preemption Not In Effect	Preemption In Effect
Flashing Light Signals and Bell	Flashers Operating	FLASHK	Signals Flashing	Signal Not Flashing
	Flasher Light Out	FLASHLOK	Signal Light OK	Signal Light Out
	Bell Operating	BELLK	Bell On	Bell Off
Gate	Gates Up	GPK (1GPK, 2GPK, ...)	Gate Up	Gate not Up

Equipment Type	Function Description	Indications	Indications True	Indications False
	Gates Down	GDK (1GDK, 2GDK, ...)	Gate Down	Gate not Down
EGM (electronic gate mechanism)	Fault Operations	EGMK (1EGMK, ...)	Normal	Faulty
AC Power, Battery and Faults	Power On	POK	AC Power On	AC Power Off
	Ground Fault Detected	GFK	Grounded	Not Grounded
	Low Battery Alarm	LOWBATTK	Low Battery Voltage Alarm	No Low Battery Voltage Alarm
	High Battery Alarm	HIGHBATTK	High Battery Voltage Alarm	No High Battery Voltage Alarm
	Charger Health	CPOK	Charger Healthy	Charger Fail
Bungalow Door	Door(s) open / close	DOORK	Door closed	Door open
Deactivation Jumper	Deactivation Jumper Applied or Not	JUMPK	Jumper Not Applied	Jumper Applied
Communication Status	NV Communications Link Health	NVCOMHLTHK	Comms OK	Comms Fail
	Vital Communications Link Health	VCOMHLTHK	Comms OK	Comms Fail

7. Defect Detection System

7.1 Introduction

- 7.1.1 Defect detection equipment shall comply with AREMA C&S Manual Section 5 - Defect Detection Systems, and GO Transit Signals and Communications Standards, SCP 921 - Wayside Inspection System (WIS) Site Selection Guidelines.
- 7.1.2 Metrolinx continually develops and utilizes a variety of systems to detect the changing physical condition of the track roadbed and embankments caused by unforeseeable environmental events, as well as wayside inspection devices to detect potentially hazardous equipment defects. Depending on the design, these systems may detect and report hazards and defects in different ways. Failures may be detected mechanically or electronically and the failure may be reported to train crews via a train to wayside radio, reported as an alarm to the GTCS and/or acted upon by the CTC Signal System.
- 7.1.3 The following sections provide requirements for the various types of defect detectors that shall be provided in accordance with the specific contract requirements.

7.2 Railway Grade Failure Detector

- 7.2.1 Railway Grade Failure Detectors, also referred to as Washout Detectors (WOD) or Ballast Integrity Sensors (BIS), are trackside devices that will guard against the possibility of derailments by detecting ballast erosion or shifting of ballast and the sub-grade beneath the railway tracks.
- 7.2.2 The WOD or BIS shall transmit alarms to the wayside CTC Signal System then to GTCS, or to GTCS directly.
- 7.2.3 The WOD shall broadcast alarm messages to the Driving Crew of a train.
- 7.2.4 The WOD or BIS shall comply with:
 - a) AREMA C&S Manual Section 5.1.13 - Recommended Design Criteria for Ballast Integrity Detectors.

7.3 High Water Alarm Detector

- 7.3.1 High Water Alarm Detectors (HWADs) shall monitor the rise of water that could impair the loading capability of the track structure or of a bridge and/or create inadequate clearance for boats on navigable waters to pass under railway bridges.
- 7.3.2 The HWAD shall transmit alarms to the wayside CTC Signal System then to GTCS, or to GTCS directly.
- 7.3.3 The HWAD shall broadcast alarm messages to the Driving Crew of a train.

7.4 Wayside Inspection System

- 7.4.1 The Wayside Inspection System (WIS) comprises trackside devices that shall monitor various equipment components of a train as it passes an inspection point and report any exceptions to normal operational levels, including detection of:
 - a) Hot Journal/Bearing (HBD)
 - b) Hot Wheel (HWD)
 - c) Dragging Equipment (DD)
- 7.4.2 The WIS shall broadcast alarm messages to the Driving Crew of a train and transmit alarms to GTCS.
- 7.4.3 The WIS devices shall comply with:
 - a) AREMA C&S Manual Section 5.3.11 - Recommended Instructions for Inspection and Test of Wayside Inspection Systems, and
 - b) GO Transit Signals and Communications Standards SCP 901, SCP 902, SCP 921, GI 301(h), GI 501, and GI 501(a).

7.5 Wheel Impact Load Detector

- 7.5.1 Wheel Impact Load Detectors (WILD) shall measure wheel loads to identify either out of round conditions or flat spots.
- 7.5.2 The WILD shall detect impact loads greater than 90,000 lb, which is specified in Rule 41 of the AAR Interchange Manual as the threshold for wheel replacement.
- 7.5.3 The WILD shall transmit alarms to the Willowbrook Yard Mechanical Department, but no further action is required on wayside CTC Signal System or GTCS.

7.6 Automatic Equipment Identification

- 7.6.1 The Automatic Equipment Identification (AEI) devices shall read AEI tags affixed to the trains that comply with AAR standard S-9203. The AEI reader system shall be able to generate "clean consist lists" where a clean consist is defined as: "A train consist, properly identified in standing order, where orientation of tagged equipment is provided, location of untagged equipment moving on wheels is provided, and total count is accurate."
- 7.6.2 The AEI reader shall comply with AAR RP-9203.
- 7.6.3 The CTC Signal System shall not take any action in terms of stopping or alarming trains as a result of the output of the AEI devices.
- 7.6.4 The AEI devices shall comply with:
 - a) AREMA C&S Manual Section 5.3.2 - Recommended Instructions for Automatic Equipment Identification (AEI), System Site Configuration and Section 5.3.12 - Recommended Instructions for Inspection and Test of Automatic Equipment Identification (AEI) Reader Systems, and
 - b) GO Transit Signals & Communications Standards GI 301(h), GI 336, GI 336(a), and GI 336(b).

8. Data Communications System

8.1 CTC Signal System Location

- 8.1.1 VMIS shall include Ethernet ports to support interface with adjacent VMISs, and include serial and / or Ethernet ports to interface with a non-vital system such as the GTCS.
- 8.1.2 Communications between a VMIS and the GTCS shall be redundant.
 - a) Redundant fibre (ring topology preferred) shall be the preferred means of communication.
 - b) For locations where fibre is not feasible, LTE and ATCS data radio shall be the primary and secondary means of communication.
 - i. Dual LTE is the primary and secondary means of communication at Guelph subdivision.
- 8.1.3 Design contractor shall design the data communication infrastructure in the field to support interface with GTCS, and the remote monitoring and diagnostic functions.

8.2 Grade Crossing Location

- 8.2.1 The primary means of communication between GCWS and the NOC/BRC shall be via a fibre optic connection. A LTE connection is acceptable where fibre is not available, however the fibre connection capabilities shall be reserved in the design.
- 8.2.2 Beside the remote monitoring and diagnostic function, grade crossing location may be required to provide CCTV and Intercommunication between crossing location and NOC/BRC.
- 8.2.3 Design contractor shall design the infrastructure in the field to support such data communications.

9. Power Service

9.1 General

- 9.1.1 The AC power shall be designed for 120V/240V and/or up to 600 V applications, depending upon the utilities available at the location and the actual applications.
- 9.1.2 Utility service shall be 200A (nominal).
- 9.1.3 Design contractor shall coordinate with utilities for AC power service requirements;
- 9.1.4 The AC power distribution shall be designed from the utility drop to a NEMA 4 rated power case, and then distributed from the power case to equipment house and SCD.
- 9.1.5 Step up and step down transformer shall be provided as necessary.
 - a) Transformer shall be placed outside the equipment house.
 - b) Transformers shall be dry type and CSA approved.
 - c) Transformers shall be in a NEMA 4 enclosure if not rated for outdoor use.

9.2 Design Submittals

- 9.2.1 The design contractor shall provide an electrical design including the following:
 - a) Single line power distribution diagram,
 - b) Bill of Material (BOM),
 - c) Cable routing diagram, and
 - d) Power calculations.
 - i. Load calculations,
 - ii. Product sizing,
 - iii. Voltage drop, and
 - iv. Breaker coordination study.

- 9.2.2 Design contractor shall produce the following additional analysis when directed by Metrolinx to show compliance for the mitigation of electrical hazards for the AC power distribution system:
- a) Arch flash analysis,
 - b) Lightning protection analysis,
 - c) grounding and bonding study, and
 - d) step and touch potential analysis.

10. Signalling System Hardware

10.1 General Requirements

10.1.1 Signalling System hardware shall comply with AREMA C&S Part 11.5.1 "Recommended Environmental Requirements for Electrical and Electronic Railroad Signal System Equipment".

10.1.2 Design contractor shall provide Bill of Material to Metrolinx for review and approval.

10.2 Batteries and Chargers

- a) The design of the batteries and chargers, and minimum standby power requirements, shall comply with:
 - i. SCP-1401 Safety Instructions for Vented Storage Batteries; and
 - ii. SCP-1402 Storage Batteries and Rectifiers.
- b) The functional design and operating guidelines for battery chargers shall comply with AREMA C&S Manual Part 9.2.6, "Recommended Functional/Operating Guidelines for a Battery Charger".
- c) Chargers shall be equipped with at least 1 dry contacts for local monitoring purposes and all charger failures shall be detected and reported to GTCS.
- d) Preferred charger type is C-Can RLW 12/600E, or equivalent approved by Metrolinx.

10.3 Vital Microprocessor Interlocking System

10.3.1 New VMIS shall support the interfaces with existing Signalling System equipment. Where necessary, the VMIS shall include vital relays (such as for switch machine control) to provide an interface to wayside equipment.

10.3.2 The VMIS shall be equipped with a data recorder and diagnostic system capable of being accessed locally, and shall support remote access capability.

10.3.3 The VMIS diagnostic system shall be capable of identifying a failure, the nature of the failure, and the components that have failed.

10.3.4 VMIS time shall be synchronized with the GTCS.

- a) Time of VMIS shall be synchronized with the other electronic equipment within the same equipment house.

10.3.5 VMIS shall be protected against electric noise transmitted from external sources including radio, vehicle propulsion systems and high voltage commercial power lines. Lightning protection including appropriate lightning arresters and equalizers shall be appropriately sized and be provided at all interface input terminals.

10.3.6 As directed by Metrolinx, the VMIS for a location which is critical to Metrolinx train service shall incorporate redundancy such that if one controller fails, another controller shall immediately and automatically assume control for its functions and territory without operational impact.

10.4 Local Control Panel

10.4.1 Each Control Point shall be equipped with a LCP that:

- a) consists of a mechanical panel performing local control panel functions;
- b) is designed and installed with the same orientation as the track and signal layout outside of the bungalow; and
- c) is sized such that it can display the complete layout of the territory controlled from the location.

10.4.2 Preferred LCP type is QLCP, or equivalent approved by Metrolinx. Computerized LCP may be provided subject to Metrolinx approval.

10.5 Wire and Cable

10.5.1 Wire and cable design shall comply with the GO Transit Signals & Communications Standards, SCP 1000 series and AREMA C&S Manual Section 10.

10.5.2 Design contractor shall design direct connections between Signalling System equipment inside the bungalow and shall avoid intermediate terminations.

- a) If intermediate terminations are absolutely required, they shall be provided using WAGO terminal or terminal straps.

10.5.3 Twisted pair cables shall be used for track circuits to minimize crosstalk between the pairs.

10.5.4 Communication and signalling cables shall be segregated from power cables while sharing a common trough or raceway.

10.5.5 Gauge of all wiring and cable shall be clearly identified within the circuit design.

10.5.6 No more than 2 wires are to be connected on any terminal or relay contact. This does not apply to a small wire from a resistor, diode or capacitor which may be added.

10.5.7 All wires and cables shall be tagged in the circuit plan.

10.5.8 Signalling System cable (except cable for track circuit) shall include spare conductors (20% is desired).

10.6 Surge Arrestors

10.6.1 Surge protection shall be provided for all apparatus exposed to the effects of lightning and induced voltage surges in accordance with AREMA C&S Manual Parts 11.2 and 11.3, GO Transit Signals & Communications Standards SCP 1101, and equipment application recommendations from the equipment suppliers.

10.6.2 Surge protection shall be coordinated with the voltage withstanding characteristics of the apparatus that it is to protect.

10.6.3 Suitable secondary surge protection that complies with AREMA C&S Manual Part 11.3.2 shall be provided between the power supply and electronic equipment.

10.7 Switch Machine

10.7.1 Dual control M23B switch machine with 110 VDC motor is the standardized switch machine for any switches outside of the USRC.

10.7.2 Switch machine selector lever contact shall be input into VMIS.

10.7.3 Switch position (NWP or RWP) of each end of a crossover shall be independently input into VMIS.

10.8 Switch Clearing Device (SCD)

10.8.1 Hot air SCDs shall be designed in accordance with GO Transit Signals and Communications Standards - Switch Clearing Device Specification, RC-0506-03SIG-09.

10.8.2 SCDs shall comply with AREMA C&S manual, part 12.6.20 "Recommended Design Criteria for an Ambient Air Switch Clearing Blower" and GO Transit Signals & Communications Standards - SCP 800.

10.8.3 SCDs shall be remotely controlled, either by Signalling System or SCADA.

10.8.4 SCDs shall be provided with an external lockable disconnect switch in the vicinity of the SCD.

10.9 Relays

10.9.1 Relays shall comply with AREMA C&S Manual Section 6.

10.9.2 Plug in type relays shall be used for all vital circuits.

10.9.3 Relays shall be named based on the nomenclature of the functions.

10.10 Load Center (Breaker Panel)

10.10.1 Load center shall be CSA approved and CSA labelled.

- 10.10.2 Proper ampacity sizes and symmetrical short circuit rating shall be coordinated with load and short circuit calculations in accordance with CSA C22.2 No 29.
- 10.10.3 Load center shall have provision for a minimum of 25% spare of each utilized type of branch breakers.
- 10.10.4 Panel circuits shall be phase balanced and shall contain a panel circuit schedule. The schedule shall indicate the loads and the feeding breakers.
- 10.10.5 Load center shall be configured to prevent against any fault current flowing through the neutral back to the power service, and shall mitigate all electrical touch potential hazards.
- 10.10.6 Surge suppressor device shall be provided on the load center to protect all phases. ERICO EPD 120/240 TDFL is the preferred surge suppression device for such application.
- 10.10.7 Interlocked switch transfer kits shall be installed between the service breaker and the generator power supply breaker.
- a) The generator power supply breaker shall be mechanically interlocked with the service breaker to ensure only one supply is on line at any given time.

10.11 **Wayside Case**

- 10.11.1 Wayside case is permitted where housing is required but spatial constraints prevent the installation of bungalow.
- 10.11.2 Wayside case shall comply with AREMA, and shall have been previously installed and approved for use by Class 1 railroads within North America.
- 10.11.3 Multiple unit terminal blocks for wire and cable conductors shall be in accordance with AREMA C&S Manual, Part 14.1.6.
- a) Test links shall be provided for the connections between cable and case wire.
- 10.11.4 Wayside case shall be equipped with 10% spare terminals and surge arrestors.
- 10.11.5 A lamp holder with a 120 V AC lamp receptacle, light switch and LED light shall be provided in wayside case. In instances where cases contain more than one (1) door, two (2) LED lights shall be provided.
- 10.11.6 A 120V convenience receptacle shall be provided in wayside case.

10.12 **Junction Box**

- 10.12.1 Junction box shall be corrosion resistant, dust and water proof enclosures.
- 10.12.2 Junction box shall have adequate venting to prevent condensation buildup.
- 10.12.3 Junction box shall be of sufficient size for the required number of terminals including 20% spare terminals with all terminals accessible from the front.

10.12.4 Junction box shall accommodate the minimum bending radius of wires and cables, include strain relief of all cables.

10.12.5 Junction box covers shall be lockable and shall not open in the path of the train dynamic envelope.

10.13 Cable Terminals

10.13.1 Cable terminals shall comply with GO Transit Signals & Communications Standards , SCP 1003 - "Standard Terminals & Tools for case wiring".

10.13.2 Terminals and terminal blocks shall be provided in accordance with AREMA C&S Manual Section 14.

10.13.3 Test links shall be provided on terminals for the isolation of the wire connections to the equipment for test purposes.

10.13.4 Nuts and washers shall be in accordance with the AREMA C&S Manual Part 14.1.11. For molded terminal blocks, 2 binding nuts, 1 clamp nut and 3 washers for all terminals including spares shall be provided for wayside case and junction box.

10.13.5 Low Impedance Ground Plane (LIGP) in equipment house shall be equipped with terminal blocks for dirty and clean side terminations. These terminal blocks shall be through hole terminal with insulation block connected to the aluminum ground plane.

10.14 Light Emitting Diode (LED) Signal

10.14.1 Tri-Color LED signal shall be provided in compliance with the GO Transit Signals & Communications - Wayside LED Signal Module Specification, RC-0506-03SIG-05.

10.15 Ground Fault Detector (GFD)

10.15.1 GFD shall be provided to detect ground fault on both AC (if it is floating) and DC power distribution systems.

10.15.2 GFDs shall obtain operating power from the signal supply and be resettable locally.

10.15.3 The sensitivity of each GFD shall be such as to detect ground faults or combinations of ground faults which will permit a current greater or equal to 25% of the lower current threshold of a vital input to VMIS.

11. Signalling System Software

11.1 General Requirements

11.1.1 The design contractor shall comply with the following design principles for application software and the configuration management process for maintaining version control of all vital and non-vital Signalling System software for both executives / boot software (supplied from equipment supplier) and application software.

11.1.2 The requirements contained in this section shall apply to Signalling System products used in any vital applications, including:

- a) Electronic Coded Track Circuits,
- b) Grade Crossing Controllers, Predictors / Motion Detectors,
- c) VMIS and all associated Printed Circuit Boards,
- d) Electronic Timers,
- e) Defect detectors, and
- f) Other electronic devices.

11.2 Design Requirements

11.2.1 Principles defined in this manual shall be used as the guideline by design contractors to produce site specific application software.

- a) Design contractor shall ensure the safety and integrity of any application software that is placed in service.

11.2.2 Software configuration management shall comply with the recommendations and instructions specified in the following:

- a) AREMA C&S Manual, Part 17.5.1 and Part 17.5.2, and
- b) GI 301(t), GI 335(a) & GI 335(b).

11.2.3 When a location being modified requires an application software change, Metrolinx will provide the existing application software to design contractor, who shall use those files as the revision baseline, and modify the existing application software.

11.2.4 The design contractor shall incorporate the executive and boot software approved by Metrolinx. The latest executive software version is not always necessarily the version approved by Metrolinx. The detailed information of executive software such as file name, part number, Checksum, CRC etc., shall be clearly defined in the Program Configuration design within circuit plan for the location.

11.2.5 The non-vital and vital software shall be segregated in application software.

11.2.6 Application software shall be documented using either Boolean Equations or Ladder Logic.

- a) Configuration settings in application software for vital functions shall be cross checked via hardware jumpers or dip shunt switches. Cross check is not required for non-vital functions.
- b) All equations in application software shall have the notes describing the equation functions.

11.2.7 All configuration settings shall be reflected in the Program Configuration design within the circuit plan for the location.

11.2.8 Vital timers shall be configurable by authorized users in the application software.

11.3 Typical Nomenclature for Application Software

11.3.1 The nomenclature related with controls and indications of Signalling System shall be as defined in Section 5 and Section 6 in this manual .

11.3.2 The nomenclature of discrete inputs, outputs, and key variables within the application software shall be as defined in Table 24 for CTC Signal System location.

Table 24 - Typical Nomenclature for CTC Signal System Location

Nomenclature	Attribute	Example
AUX	Auxiliary input of Coded track circuit	1WTAUX - Auxiliary input on 1WT
T	Code 1 received on Coded track circuit	3WT - Code 1 received on 3WT
TOUT	Code 1 Transmitted on Coded track circuit	1WTOUT - Code 1 transmitted on 1WT
TC2IN	Code 2 received on Coded track circuit. Same principle applied to all other codes.	1WTC2IN - Code 2 received on 1WT
TC2OUT	Code 2 transmitted on Coded track circuit. Same principle applied to all other codes.	1WTC2OUT - Code 2 transmitted on 1WT
LO	Signal Light Out (detected by Lamp Driver)	1WAGLO - Signal 1WA Green Light Out; 1WAYLO - Signal 1WA Yellow Light Out; 1WARLO - Signal 1WA Red Light Out.
RLO	Remote Signal Light Out (Initiated from Intermediate Signal Location)	T1RLO - Light Out bit received from T1, indicating LO condition of intermediates on T1
POR	Power Off Input	POR
RPOR	Remote Power Off (Initiated from intermediate Signal Location)	T1RPOR - Power Off bit received from T1, indicating PO condition of intermediates on T1
DOOR	Door Contact Input	DOOR
SMP	SCD Operating Input	SMP
SMALP	SCD Alarming Input	SMALP
NWP	Switch Normal Position Input	1ANWP - Switch 1A Normal Position Input
RWP	Switch Reverse Position Input	1ARWP - Switch 1A Reverse Position Input
NJP	Switch On Hand Input	1ANJP - Switch 1A on Hand Input
FCN	Switch Field Normal Request Input	1FCN - Crossover (or Switch) 1
FCR	Switch Field Reverse Request Input	1FCR - Crossover (or Switch) 1
T	OS Track Input	1AT - Follow Track Circuit naming convention
GFD	Ground Fault - Input or Internal bit	B12_1GFD - B12 bank #1 ground fault

Nomenclature	Attribute	Example
RBE	Remove Block Enable Input	One per location
TU	AS Time Release Jumper Input	One per location
GE	Signal Green Output	1WAGE - Signal 1W A Head Green Output
FGE	Signal Flashing Green Output	1WAFGE - Signal 1W A Head Flashing Green Output
YE	Signal Yellow Output	1WAYE - Signal 1W A Head Yellow Output
FYE	Signal Flashing Yellow Output	1WAFYE - Signal 1W A Head Flashing Yellow Output
RE	Signal Red Output	1WARE - Signal 1W A Head Red Output
VSTOP	Vital Signal Stop Relay Output	1EVSTOP - Vital Stop Relay for Signal 1E
NW	Switch Normal Control Output	1ANW - Switch 1ANW
RW	Switch Reverse Control Output	1ARW - Switch 1ARW
SMZ	SCD Control Output	1ASMZ - Switch 1A SMZ
SMFOZ	SCD Force Off Output	SMFOZ - One Per Control Point
AS	Variable - Approach Stick	1WAS - Signal 1W Approach Stick
GZP	Variable - Signal Request Repeater	1WGZP - Signal 1W GZP
COGZP	Variable - Signal Call-On Request Repeater	1WCOGZP - Signal 1W COGZP
TE	Variable - Timer Complete	1WASTE - Signal 1W ASR Timer
TEN	Variable - Timer Enable	1WASTEN - Signal 1W ASR Timer
RP	Variable - Red Repeater	1WRP - Signal 1W RP
OL	Variable - Overload	1AOL - Switch 1A OL
L	Variable - Switch Locked	1AL - Switch 1A L
LS	Variable - Switch Locking Stick	1ALS - Switch 1A LS
NWCP	Variable - Normal Switch Correspondence	1ANWCP - Switch 1A NWCP
RWCP	Variable - Reverse Switch Correspondence	1BRWCP - Switch 1B RWCP
ERS	Variable - Eastbound Route Stick	1ERS - Track Circuit 1T ERS
WRS	Variable - Westbound Route Stick	1WRS - Track Circuit 1T WRS
TP	Variable - Track Repeater	1TP - Track 1T Repeater
HD	Variable - Codes Received for Permissive Signal Aspect	1WHD - Track 1WT HD
COS	Variable - Call-On Stick, Per Control Signal	1WCOS - Signal 1W Call-On Stick
RTTS	Variable - Return to Train Stick	1WRTTS - Track 1WT Return to Train Stick
NWZP	Variable - Normal Switch Request Repeater	1NWZP - Crossover (or Switch) 1 NWZP
RWZP	Variable - Reverse Switch Request Repeater	1RWZP - Crossover (or Switch) 1 RWZP
STK	Variable - Directional Stick	ESTK - Eastbound STK WSTK - Westbound STK
Z	Variable - Power Up Stick	Z

11.3.3 The nomenclature of key inputs and outputs within the application software for GWCS shall be as defined in Table 25.

Table 25 - Typical Nomenclature for GWCS

Nomenclature	Attribute	Example
GP	Gate Vertical (Up) Input	1GP - Gate 1 Up
GD	Gate Horizontal (Down) Input	1GD - Gate 1 Down
AXC_E_IN	Remote East Approach Start Input	AXC_1E_IN - Track 1 east approach remote start
AXC_W_IN	Remote West Approach Start Input	AXC_1W_IN - Track 1 west approach remote start
TESTSW	Test Switch Input	TESTSW
TESTSWGUP	Test Switch Gate Up Input	TESTSWGUP
XT	DC Island Input	1XT - 1XT DC Island Input
DTMF	DTMF Input	DTMF
AXC_E_OUT	Remote East Start Output	AXC_1E_OUT - Track 1
AXC_W_OUT	Remote West Start Output	AXC_1W_OUT - Track 1
BELL	Bell Output	1BELL - Bell 1 Control
GATE_CNTRL	Gate Control Output	1GATE_CNTRL - Gate 1 Control
IXC_FLASH	Flasher Control Output	1IXC_FLASH - Flasher Output on #1 crossing controller
PER	Preemption Relay Output	PER
XR	Variable - Crossing Control	XR

11.4 Design Guidelines for Key Functions

11.4.1 Approach Stick (AS)

- a) The AS variable shall be normally energized and shall be de-energized to lock the switches and route. The time locking timer associated with the AS shall be normally de-energized and designed to energize the AS variable after a predetermined period of time.
- b) The AS variable shall become de-energized (false) when the associated signal is cleared or when the route has been established. Time locking shall be employed by using a timer variable that holds the AS false if the approach locking is not in effect, until a pre-determined time interval has elapsed, after the signal request is cancelled and the signal has returned to STOP.
- c) The AS variable shall be restored, and time locking released after the sequential two-track release logic is established, taking into account that:
 - i. improper occupancy sequence of the two tracks shall not release the AS variable, and
 - ii. time locking shall be in effect in the event of VMIS reset, or when the VMIS power has been interrupted and restored.

11.4.2 AS Reset

- a) The AS reset function shall allow the authorized personnel to reset or cancel the time locking timer while the VMIS is in Local Control Mode to expedite testing.

- b) The AS reset function shall only be enabled when the AS reset input has been energized by the manual placement of a jumper wire. It shall be automatically disabled when:
 - i. VMIS is not in Local Control; or
 - ii. Jumper wire is removed; or
 - iii. 60 minutes have elapsed since the AS reset jumper wire has been applied.

11.4.3 Route Stick

- a) Route stick equation shall be used to lock switches and routes.
- b) The route stick equation shall lock a route when a route is lined. Track occupancy alone shall not lock the route.
- c) The route stick equation shall be normally true.

11.4.4 Route Check

- a) The route check shall provide a circuit check before a signal may be cleared by ensuring that:
 - i. the track switches are in correspondence with their control relays and locked,
 - ii. the opposing signals are in the stop position and are not requested,
 - iii. the opposing route is not established, and
 - iv. track blocking is not in effect.

11.4.5 Switch Correspondence

- a) Switch correspondence back check shall be made in each switch correspondence equation.
- b) The NWP/NWPR false shall be used to enable the RWPR equation and the RWP/RWPR false shall be used to enable the NWPR equation.

11.4.6 Vital Communication Link

- a) Communication link status shall be checked in all received logic equations that utilize the associated link.
- b) Link logic variable labels shall match the nomenclature on the hardware circuit plans.
- c) Loss of vital link shall cause the associated received logic variables to revert to their most restrictive state.
- d) Loss of vital link shall not cause an unsafe conditions such as prematurely establishing the Call-On or RTT sticks.

11.4.7 Power Up Stick

- a) Power Up Stick (Z) equation shall be employed to verify that the VMIS has initialized to a normal state without errors after being reset or when power is restored to the system.
- b) Z shall be employed to check that all ASs are normal after power up and that the key modules and vital serial links to other VMISs remain healthy once the system is running.

- c) Z shall be used in AS to ensure that VMIS does not allow AS to energize immediately when VMIS first starts up, but only after the longest AS timer has expired. This is critical to safe operation since all track circuits will show as occupied during the system initialization which in turn would allow the AS to energize immediately.
- d) To avoid running time unnecessarily on VMIS start up, Z may include a parallel path to verify that the OS track circuits are not occupied and all approach tracks are vacant.

11.4.8 Detector Track Circuits

- a) All detector track circuits shall be configured a 10 seconds slow pickup timer for loss of shunt protection.
 - i. Design contractor shall ensure loss of shunt timer does not introduce timing issue.
- b) Detector track locking shall be implemented on all switches.

11.4.9 Track Codes

- a) Standard Metrolinx track code assignment shall be used for all new work unless Metrolinx specifically directs and approves an alternative. Deviations from the use of standard codes or their application may be required to tie into foreign railroads or when modifying an individual location to match the rest of a subdivision.
- b) Transmission of any track codes at Control Point for approach signal displaying permissive aspect shall check Code 1 is received.

11.4.10 Signal Approach lighting

- a) Signals shall be constantly lit except when there is an AC power failure or charger failure at the location. Failure at adjacent location shall not change the location into approach lighting.
- b) During AC power off or charger failure, all signals that have an approach circuit of adequate sighting distance shall be approach lit to conserve batteries.
- c) External two way toggle switch dedicated for lighting signal shall be designed to facilitate test and maintenance. Signal shall be lit steady when toggle switch is toggle to On position.
- d) Where closely spaced signals exist, it may be necessary to employ lighting circuits to keep the far signal at stop if there is a burnt out lamp at the signal being approached. The practice is commonly known as leapfrog approach lighting.

11.4.11 Switch Overload

- a) Switch overload protection shall be provided for all power operated switches.
- b) Switch overload timers shall typically be configured as 10 seconds timer, on M23B switch machines, with 189 to 1 gear ratio.
- c) Application software shall reset the overload when the OS track becomes occupied or when the switch is placed on hand, as detected through the selector lever contact.
 - i. Selector lever input shall be configured with a 10 seconds slow pickup timer.

11.4.12 Controls from GTCS

- a) Controls from the GTCS shall be latched for 2 seconds then discarded within the Non-Vital application software.

11.4.13 Chassis ID

- a) When applicable, the Chassis ID shall be programmed into all new and revised installations.
 - i. Design contractor shall request Chassis ID assignments from Metrolinx.

11.4.14 Ground Fault Detection

- a) Ground fault alarms for all DC power busses within Signalling System equipment housing shall be collected in the application software.

11.4.15 Battery Alarms

- a) Battery low and high voltage alarms shall be collected in the application software for all battery banks within Signalling System equipment housing.

11.4.16 Door Alarms

- a) Door alarm circuit shall be employed for all bungalow doors.
- b) Door alarm shall be triggered when the door is open.

11.4.17 Switch Clearing Device (SCD)

- a) SCD "forced off" control shall be implemented for all switch clearing devices except RECO SCD, based on the "force off" feature built into the product.

11.4.18 Stuck Mechanism

- a) Where signal mechanisms are used, logics for stuck mechanism shall be provided.

11.4.19 Vital Stop Relay Lighting

- a) Sufficient relay contacts shall be provided to light at least the top red lamp on each controlled signal when the Vital Stop Relay is de-energized.

11.4.20 Light Out Downgrades

- a) Application software shall comply with the light out downgrade principles defined in this manual.

11.4.21 Directional Stick at Intermediate Signal Location

- a) This section defines the eastbound (southbound) directional stick operations. The same principles apply to the westbound (northbound) directional stick.
- b) The west approach flag shall not be set until code for displaying permissive aspect is received from the east, and the west track circuit is occupied for 10 seconds.
- c) After the west approach flag is set, and the train shunts both the west and east track circuits, the eastbound stick shall be energized.

- d) When the eastbound stick is energized, Code 8 shall be transmitted to the west and the westbound signal shall be Red.
- e) The eastbound stick shall be de-energized when Code 6 is received from the east, or any codes for displaying permissive aspect are received from the east and the east block is energized.

11.4.22 Code 6 Transmission at Intermediate Signal Location

- a) Code 6 shall be transmitted to the east when code 6 is received from the west; when No Code is received from the west (e.g. broken rail), Code 6 shall be transmitted to the east. The same principles apply to the Code 6 to be transmitted to the west.
- b) Auxiliary input is normally used as the input for either hand throw switch, or crossing DC island. When the east auxiliary input is de-energized,
 - i. Code 6 shall be transmitted to east, followed by Code 1;
 - ii. Code 6 shall be transmitted to west if the east stick is not established, followed by Code 1, and
 - iii. transmission of Code 5 shall be discontinued if it was transmitted before the auxiliary input was de-energized.
- c) When the west auxiliary input is de-energized,
 - i. Code 6 shall be transmitted to west, followed by Code 1;
 - ii. Code 6 shall be transmitted to east if the west stick is not established, followed by Code 1, and
 - iii. transmission of Code 5 shall be discontinued if it was transmitted before the auxiliary input was de-energized .

11.5 Code Line Configurations

11.5.1 Complete code line configuration shall be provided. The code line configuration data shall appear on the Signalling System Program Configuration design.

11.5.2 Metrolinx will assign and maintain code line configuration data for leased fibre and LTE, radio code lines, and ATCS addresses for code line applications.

11.5.3 Design contractor shall request Metrolinx for code line configuration and ATCS addresses.

11.6 Event Recording

11.6.1 Recording equipment shall be provided to record the changes of states for vital and non-vital I/Os and variables.

11.6.2 Recording capacity shall be sufficient to provide at least 48 hours of activity under normal circumstances for CTC Signal System.

11.6.3 As the minimum the following bits shall be recorded within the VMIS:

- a) Input and Output, including any physical inputs and outputs, and inputs and outputs in the vital communication link between VMISs

- b) Track Circuits variable
- c) Applicable track code input status
- d) Applicable track code output status
- e) All Vital variables
- f) All Non Vital variables
- g) Link status
- h) Vital timers
- i) CTC Indications
- j) CTC Controls
- k) Local Control Panel Inputs

11.6.4 The following bits shall not be recorded:

- a) Bit changing the status frequently such as bit for flashing LED indicator on LCP;
- b) Output for LCP indicators;
- c) Non-Vital timers.

11.7 Software Description Document

11.7.1 The design contractor shall provide a software description document that describes the required functions of the application software and operational changes for the revised software.

11.7.2 The following information shall be provided in the software description document.

- a) Program name and locations to be used.
- b) The version of the program, date when the changes were made, the company that made the changes, the designer, checker and approver who made the change.
- c) The name and version of the development environment (tools) used to create the software; the official authorization of the development tool from the VMIS supplier.
- d) The applicable checksum, CRC and/or other unique identifier information for the program provided by the application development tools.
- e) Functional description of the functions and features implemented in the application software.
- f) A compatibility summary describing any hardware or software configuration items in the system, including:
 - i. Any jumper, dipswitch or strap settings that may be required;

- ii. When applicable, any hardware or software revisions that cannot be used with this software shall be explicitly identified.
- g) Any user requirements and operational constraints that must be satisfied to ensure safety when using this software.
- h) Any deviations from this manual.
- i) Where applicable, a change summary showing the changes implemented in the software release as compared to the previous revision(s).

11.8 Configuration Management

11.8.1 The configuration management will:

- a) establish the baseline of both executive / boot and application software products based on their approved version for testing;
- b) ensure a proper method is in place to document the tracing of all revisions to its respective baseline; and
- c) comply with AREMA C&S Manual and GO Transit Signals and Communications Standards GI 301 (t) - Software Configuration Management.

11.8.2 The design contractor or Field Engineer shall be responsible for issuing and documenting application software revisions that may be required once the design reaches the field.

11.8.3 The design contractor or Field Engineer shall only issue software revisions to the field when authorization has been provided from Metrolinx.

11.9 Configuration Information Reporting

11.9.1 Metrolinx is the custodian of the version control for the installed baseline of Metrolinx vital and non-vital software and executive / boot software.

11.9.2 When a new location is placed in service, or an existing location is revised, the field personnel responsible for the in service testing shall submit to EOR and Metrolinx a copy of the Software Configuration Report within 24 hours of placing that location in service. The report shall be verified by design contractor or Field Engineer who shall notify Metrolinx for compliance and completeness.

11.10 Reduced Validation

11.10.1 The use of Reduced Validation Test Procedures for the Validation of application software requires written authorization from Metrolinx prior to test and execution.

- a) When authorization is granted it will be for a specific location and specific revision.
- b) This written authorization shall itself be a configuration item and incorporated into the software revision control records.

11.10.2 The design contractor or Field Engineer shall be responsible for preparing Reduced Validation Design package, before the production of the Reduced Validation Test procedures by testing personnel.

11.10.3 The Reduced Validation Design package shall be submitted to the Metrolinx for approval, including the following configuration information:

- a) Software description, including:
 - i. List of software modified,
 - ii. Revision functional description and change summary,
 - iii. Explanations of engineering change process being implemented for the configuration control during revisions, and
 - iv. Explanations of procedures and tools employed to ensure the revision has been made only to the contents intended without accidentally or unintentionally modified anything else.
- b) Configuration data, including:
 - i. Part numbers and revision levels of all software and related hardware configuration items as applicable,
 - ii. Existing software Checksums, CRCs, or Unique Check Numbers UCNs, Software Version,
 - iii. Revised software Checksums, CRCs, or Unique Check Numbers UCNs, Software Version, and
 - iv. Configuration settings as applicable.
- c) Difference report, including:
 - i. Detailed comparison report clearly illustrating existing and revised logics, and
 - ii. Detailed comparison report illustrating any existing and revised configuration items.
- d) Location design including:
 - i. Layout of all track and signal components (track circuits, signals, switches) with proper nomenclature,
 - ii. Aspect chart(s), and
 - iii. Design drawings (PDF) if applicable.

11.10.4 Reduced Validation Test Procedures shall include sequential and comprehensive test procedures outlining the following:

- a) Resource, time, and duration plan,
- b) Software installation procedures, and
- c) Detailed reduced test validation procedures.

11.11 Software storage and archiving

11.11.1 Metrolinx maintains the EDRMS for the secure storage and easy access of Signalling System software programs.

11.11.2 When contractor works on the changes to existing application software or creating new application software, the design contractor and Field Engineer shall comply with its internal software management process and provide evidence of compliance to Metrolinx, whenever it is requested by Metrolinx.

12. GTCS Changes

To be developed.

13. Supervisory Control and Data Acquisition (SCADA)

To be developed.

14. Train Control System Interface

To be developed.

15. Electrification Compatibility

To be developed.